

www.vskom.de

User Manual NetCom Plus

Edition: February 2022



Tel: +49 40 528 401 0

Fax: +49 40 528 401 99

Web: www.visionsystems.de

Support: service@visionsystems.de

The software described in this manual is furnished under a license agreement and may be used only in accordance with the terms of that agreement.

Copyright Notice

Copyright © 2009-2022 Vision Systems. All rights reserved. Reproduction without permission is prohibited.

Trademarks

VScom is a registered trademark of Vision Systems GmbH. All other trademarks and brands are property of their rightful owners.

Disclaimer

Vision Systems reserves the right to make changes and improvements to its product without providing notice.

Vision Systems provides this document “as is”, without warranty of any kind, either expressed or implied, including, but not limited to, its particular purpose. Vision Systems reserves the right to make improvements and/or changes to this manual, or to the products and/or the programs described in this manual, at any time.

Information provided in this manual is intended to be accurate and reliable. However, Vision Systems assumes no responsibility for its use, or for any infringements on the rights of third parties that may result from its use.

This product might include unintentional technical or typographical errors. Changes are periodically made to the information herein to correct such errors, and these changes are incorporated into new editions of the publication.

Contents

| | | |
|----------|--|-----------|
| 1 | Overview | 12 |
| 2 | Introduction | 12 |
| 2.1 | About this Manual | 12 |
| 2.2 | Features | 13 |
| 2.3 | Product Specifications | 13 |
| 2.3.1 | Common characteristics | 14 |
| 2.3.2 | Device specific Characteristics | 14 |
| 2.3.2.1 | NetCom Plus 111 | 14 |
| 2.3.2.2 | NetCom Plus 113 | 15 |
| 2.3.2.3 | NetCom Plus 111 Mini | 16 |
| 2.3.2.4 | NetCom Plus 113 Mini | 16 |
| 2.3.2.5 | NetCom Plus 211 | 17 |
| 2.3.2.6 | NetCom Plus 213 | 17 |
| 2.3.2.7 | NetCom Plus 411 | 18 |
| 2.3.2.8 | NetCom Plus 411 POE | 18 |
| 2.3.2.9 | NetCom Plus 413 | 18 |
| 2.3.2.10 | NetCom Plus 413 POE | 19 |
| 2.3.2.11 | NetCom Plus 811 | 20 |
| 2.3.2.12 | NetCom Plus 811 POE | 20 |
| 2.3.2.13 | NetCom Plus 813 | 21 |
| 2.3.2.14 | NetCom Plus 813 POE | 21 |
| 2.3.2.15 | NetCom Plus 811 DIO | 22 |
| 2.3.2.16 | NetCom Plus 1613 | 24 |
| 2.4 | Packing List | 25 |
| 2.4.1 | Warning: | 25 |
| 3 | Hardware Description | 26 |
| 3.1 | Serial Port Configuration | 26 |
| 3.2 | Serial Signal Assignment | 27 |
| 3.3 | RS422/485 Electrical Configuration | 28 |
| 3.3.1 | Termination Resistors | 28 |
| 3.3.2 | BIAS Function | 28 |
| 3.4 | Serial Port Simple Settings | 28 |
| 3.5 | Digital Input/Output | 29 |
| 3.5.1 | Input Connection | 29 |
| 3.5.2 | Output Connection | 29 |
| 3.6 | Network | 29 |
| 3.6.1 | Ethernet and LED | 29 |
| 3.6.2 | WLAN Configuration | 30 |
| 3.6.3 | WLAN Antenna | 30 |
| 3.6.4 | WLAN LED | 30 |
| 3.7 | Power Supply | 31 |
| 3.7.1 | Terminal Block Power | 31 |
| 3.7.2 | Terminal Block Power on NetCom Plus Mini | 31 |

| | | |
|----------|--|-----------|
| 4 | Windows Virtual COM Driver | 32 |
| 4.1 | Installation Procedure | 32 |
| 4.1.1 | Start the Installation Wizard | 32 |
| 4.1.1.1 | User Account Control (UAC) | 33 |
| 4.1.1.2 | Methods of Installation | 34 |
| 4.1.1.3 | Proceed Installation | 34 |
| 4.1.1.4 | Request for Trust | 35 |
| 4.1.2 | Find and Configure NetCom ⁺ Devices | 36 |
| 4.1.2.1 | Configure IP Parameters | 37 |
| 4.1.2.2 | Configure Firewall | 39 |
| 4.1.3 | Install Drivers | 39 |
| 4.2 | Verify the Installation | 40 |
| 4.3 | Update the Drivers and Tools | 41 |
| 4.4 | Configuration of the Virtual COM Driver | 41 |
| 4.4.1 | Configure the Serial Ports | 41 |
| 4.4.2 | Performance Issues | 42 |
| 4.4.3 | Network & Misc Properties | 44 |
| 4.4.4 | Remote Settings Properties | 46 |
| 4.4.5 | Installation of NetCom Plus Servers | 48 |
| 4.4.5.1 | Changing the Installation | 50 |
| 4.5 | Uninstall the Drivers and Tools | 51 |
| 5 | Configure with NetCom Plus Manager | 52 |
| 5.1 | Starting NetCom Manager | 53 |
| 5.2 | NetCom Server Settings – Info | 54 |
| 5.3 | NetCom Server Settings – Ports | 55 |
| 5.4 | NetCom Server Settings – Firewall | 56 |
| 5.5 | Manual Detection/Installation of a NetCom | 57 |
| 5.6 | Firewall Traversal Configuration | 57 |
| 5.6.1 | SOHO Firewall example | 57 |
| 5.6.2 | SOHO Virtual Servers | 58 |
| 5.6.3 | NetCom Detection through SOHO Firewall | 58 |
| 5.6.4 | Serial Ports through SOHO Firewall | 59 |
| 5.6.5 | DMZ and Virtual Servers | 60 |
| 5.6.6 | Firewalls in Foreign Networks | 60 |
| 5.7 | Dynamic IP Address and OpenVPN™ | 61 |
| 6 | Configure the Operation Modes | 62 |
| 6.1 | Accessing the Configurations | 62 |
| 6.1.1 | Web Browser Configuration | 63 |
| 6.1.2 | Telnet Configuration | 64 |
| 6.1.3 | Serial Configuration | 65 |
| 6.1.4 | SNMP Configuration | 65 |
| 6.2 | NetCom Configuration Options | 66 |
| 6.2.1 | Server Configuration | 66 |
| 6.2.1.1 | Server Info | 66 |
| 6.2.1.2 | Server Parameter | 67 |
| 6.2.1.3 | Wireless Parameter | 70 |
| 6.2.1.4 | Encrypted Communication | 72 |
| 6.2.1.5 | viaVPN Remote Management and Access | 72 |

| | | |
|-----------|--|------------|
| 6.2.1.6 | Node-RED GUI Programming | 75 |
| 6.2.1.7 | Modbus GPIO | 76 |
| 6.2.1.8 | Authentication | 77 |
| 6.2.1.9 | Date & Time | 77 |
| 6.2.1.10 | Save | 79 |
| 6.2.2 | Serial Port Configuration | 79 |
| 6.2.2.1 | Serial Settings | 80 |
| 6.2.2.2 | Transfer Settings | 82 |
| 6.2.2.2.1 | Driver Mode | 83 |
| 6.2.2.2.2 | TCP Raw Server | 84 |
| 6.2.2.2.3 | TCP Raw Client | 85 |
| 6.2.2.2.4 | Null Modem Tunnel | 86 |
| 6.2.2.2.5 | TCP Advanced Settings | 88 |
| 6.2.2.2.6 | UDP Data Transfer | 89 |
| 6.2.2.2.7 | IP-Modem | 90 |
| 6.2.2.2.8 | Print Server Function | 92 |
| 6.2.2.3 | Save | 92 |
| 6.2.3 | NetCom Tools | 93 |
| 6.2.3.1 | Ping | 93 |
| 6.2.3.2 | Statistics | 94 |
| 6.2.3.3 | Netstat | 95 |
| 6.2.3.4 | Wireless | 97 |
| 6.2.3.5 | Firmware | 98 |
| 6.2.3.6 | Save and Load Configuration | 99 |
| 6.2.3.7 | Logging and Debug | 99 |
| 6.2.3.8 | Save | 100 |
| 6.2.4 | Reboot | 100 |
| 6.2.5 | Save&Exit Menu | 100 |
| 6.2.5.1 | Save Parameter | 100 |
| 6.2.5.2 | Exit | 101 |
| 6.2.5.3 | Reboot | 101 |
| 6.3 | Erase Configuration of NetCom | 101 |
| 7 | Operation in Linux | 102 |
| 7.1 | Via Fixed TTY Pseudo Serial Port (socat) | 102 |
| 7.2 | Via TCP Raw Server Mode | 103 |
| 8 | IP Modem Function | 104 |
| 8.1 | Some possible Scenarios | 104 |
| 8.2 | Serial Signals and Cables | 104 |
| 8.3 | Operation Modes by IP Modem | 105 |
| 8.4 | Hayes Commands | 105 |
| 8.4.1 | AT command set | 106 |
| 8.4.1.1 | Standard AT-Commands | 106 |
| 8.4.1.2 | Extended AT-Commands | 106 |
| 8.4.1.3 | Non-AT commands | 107 |
| 8.4.2 | S-Registers for Configuration | 107 |
| 8.4.3 | Sample Commands used by Windows | 107 |
| 8.5 | Description of AT-Commands | 107 |
| 8.5.1 | AT D (dial) | 108 |

| | | |
|-----------|--|------------|
| 8.5.2 | AT O (online / data mode) | 108 |
| 8.5.3 | AT A (answer call) | 108 |
| 8.5.4 | AT B (modulation) [ATB1] | 108 |
| 8.5.5 | AT E (echo) [ATE1] | 109 |
| 8.5.6 | AT Q (quiet) [ATQ0] | 109 |
| 8.5.7 | AT V (verbose) [ATV1] | 109 |
| 8.5.8 | AT H (hangup) [ATH0] | 109 |
| 8.5.9 | AT I(n) (information) [ATI0] | 109 |
| 8.5.10 | AT S (setup) | 110 |
| 8.5.11 | AT L (loudness) | 110 |
| 8.5.12 | AT M (speaker) | 110 |
| 8.5.13 | AT N (auto baud) [ATN0] | 110 |
| 8.5.14 | AT Z (reset) | 110 |
| 8.5.15 | AT &F (factory settings) [AT&F0] | 111 |
| 8.5.16 | AT &C (DCD configuration) [AT&C1] | 111 |
| 8.5.17 | AT &S (DSR configuration) [AT&S0] | 111 |
| 8.5.18 | AT &D (DTR configuration) [AT&D2] | 111 |
| 8.5.19 | AT &K (handshake) [AT&K3] | 112 |
| 8.5.20 | AT \Q [AT\Q3] | 112 |
| 8.5.21 | AT &V (view profile) | 112 |
| 8.5.22 | AT &W (save profile) | 112 |
| 8.5.23 | AT &Z (save destination) | 112 |
| 9 | Print Server Operation | 113 |
| 9.1 | Printer Queue | 113 |
| 9.2 | Printer Reset | 113 |
| 9.2.1 | Init String Definition | 113 |
| 9.2.1.1 | ASCII Text | 114 |
| 9.2.1.2 | ASCII Control Codes | 114 |
| 9.2.1.3 | Numeric Codes | 114 |
| 9.2.1.4 | Modem Control Signals | 114 |
| 9.2.1.5 | Timing Options | 114 |
| 9.2.2 | Reset Example | 114 |
| 9.3 | Operation in Windows® | 115 |
| 9.3.1 | Add a New Printer | 115 |
| 9.3.1.1 | Create new printer port | 115 |
| 9.3.1.2 | Name the new Printer Port | 116 |
| 9.3.1.3 | Configure the Printer Port | 117 |
| 9.3.1.4 | Install Printer Driver | 117 |
| 9.3.2 | Modify an Existing Printer | 117 |
| 9.3.2.1 | Open the properties | 117 |
| 9.3.2.2 | Add the Print Server Port | 118 |
| 10 | OpenVPN™ Encryption | 119 |
| 10.1 | OpenVPN™ Installation | 119 |
| 10.2 | NetCom OpenVPN Configuration | 120 |
| 10.3 | OpenVPN™ Configuration | 121 |
| 10.3.1 | Create OpenVPN™ Configuration | 121 |
| 10.3.2 | Create OpenVPN™ Certificate and Keys | 122 |
| 10.3.3 | Start NetCom Plus with OpenVPN™ active | 123 |

| | | |
|-----------|---|------------|
| 10.3.4 | Start OpenVPN™ by Context-Menu | 123 |
| 10.3.5 | Start OpenVPN™ by Command line | 124 |
| 10.3.6 | Start OpenVPN™ as Windows Service | 125 |
| 10.4 | OpenVPN™ without Encryption | 126 |
| 10.5 | Reconfigure Virtual Serial Ports for OpenVPN™ | 127 |
| 11 | viaVPN Remote Access System | 128 |
| 11.1 | Obstacles when used via Internet | 128 |
| 11.2 | How viaVPN solves the above Issues | 128 |
| 11.3 | Activation of option viaVPN | 129 |
| 11.4 | Configuration of viaVPN Parameters | 129 |
| 11.5 | Operation with viaVPN System | 130 |
| 12 | Modbus/TCP for Digital-Input/Output | 131 |
| 12.1 | Specifications | 131 |
| 12.2 | Examples | 132 |
| 12.2.1 | Read two input signals | 132 |
| 12.2.2 | Write one output signal | 132 |
| 13 | TCP/IP Description | 133 |
| 13.1 | Recommended Settings | 133 |
| 13.1.1 | Static Configuration | 133 |
| 13.1.2 | DHCP Configuration | 133 |
| 13.1.3 | Automatic Configuration (APIPA) | 134 |
| 13.1.4 | Other Configuration | 134 |
| 14 | Dimensions | 135 |
| 14.1 | Small Case for 1P / 2P NetCom+ | 135 |
| 14.2 | 19 Inch Case for 4P / 8P NetCom+ | 139 |
| 15 | Troubleshooting Guide | 142 |
| 16 | Glossary of Terms | 144 |
| 17 | Open Source Software Licenses | 147 |
| 17.1 | GPLv2 | 147 |
| 17.2 | LGPLv2.1 | 151 |
| 18 | History | 158 |

List of Figures

| | | |
|---|--|----|
| 1 | NetCom Plus 111 / 113 | 15 |
| 2 | NetCom Plus 111/113 Mini | 16 |
| 3 | NetCom Plus 213 Top, Front, Left and Back Side | 17 |
| 4 | NetCom Plus 411 / 413 Front side | 19 |
| 5 | NetCom Plus 411 / 413 / 413 POE Rear side | 19 |
| 6 | NetCom Plus 411 POE Rear side | 20 |
| 7 | NetCom Plus 811 / 813 Front side | 21 |
| 8 | NetCom Plus 811 / 813 / 813 POE Rear side | 22 |

| | | |
|----|--|----|
| 9 | NetCom Plus 811 POE Rear side | 22 |
| 10 | NetCom Plus 811 DIO | 23 |
| 11 | NetCom Plus 1613 | 24 |
| 12 | Connector | |
| | DSub-9 male | 27 |
| 13 | DIP NetCom Plus | 28 |
| 14 | Terminal Block Input | 29 |
| 15 | Terminal Block Output | 29 |
| 16 | Power Terminal Block | 31 |
| 17 | Power Terminal Block | 31 |
| 18 | Installation Wizard | 32 |
| 19 | UAC in Windows 10 (1803) | 33 |
| 20 | NetCom ⁺ Driver Installation | 33 |
| 21 | Start Driver Installation | 34 |
| 22 | Copy Driver Files | 35 |
| 23 | Install Request | 35 |
| 24 | Firewall options | 36 |
| 25 | Discover and Select NetCom ⁺ Devices for Installation | 37 |
| 26 | NetCom ⁺ in Manager | 37 |
| 27 | Define NetCom ⁺ s IP Configuration | 38 |
| 28 | DNS Name for NetCom ⁺ Server | 38 |
| 29 | Sending Parameters to a NetCom ⁺ | 39 |
| 30 | Virtual Com Ports installing in Windows 10 | 39 |
| 31 | VScom drivers in the Start Menu | 40 |
| 32 | NetCom ⁺ in Device Manager | 40 |
| 33 | NetCom ⁺ COM Port Serial Settings | 42 |
| 34 | NetCom ⁺ COM Port Performance Settings | 43 |
| 35 | NetCom ⁺ COM Port Network/Misc Properties | 44 |
| 36 | NetCom ⁺ COM Port Remote Settings Properties | 46 |
| 37 | Select NetCom ⁺ to install | 48 |
| 38 | New NetCom ⁺ | 48 |
| 39 | Installed NetCom ⁺ | 48 |
| 40 | “Bad” NetCom ⁺ | 49 |
| 41 | Excluded NetCom ⁺ | 49 |
| 42 | Disconnected NetCom ⁺ | 49 |
| 43 | NetCom Plus Manager Ports View | 50 |
| 44 | Reconfigured NetCom ⁺ found | 50 |
| 45 | Replaced NetCom ⁺ found | 51 |
| 46 | Uninstall NetCom ⁺ Drivers via Settings App | 51 |
| 47 | Remove, Repair | 52 |
| 48 | NetCom Plus Manager | 52 |
| 49 | NetCom Manager in Start Menu | 53 |
| 50 | NetCom Manager Servers Panel | 53 |
| 51 | NetCom Manager Server Settings - Info | 54 |
| 52 | NetCom Manager Server Settings - Ports | 55 |
| 53 | NetCom Manager Server Settings - Firewall | 56 |
| 54 | NetCom Manager Port Configuration for Driver | 59 |
| 55 | NetCom ⁺ as UPnP devices | 62 |
| 56 | Configuration Menu in Web Browser | 63 |

| | | |
|-----|--|-----|
| 57 | Request to Reboot in Web Browser | 63 |
| 58 | Password Request in Telnet | 64 |
| 59 | Select Terminal Type in Telnet | 64 |
| 60 | Main Menu of Configuration Console in Telnet | 64 |
| 61 | Server Information | 66 |
| 62 | Upgrade-Check | 67 |
| 63 | Server Parameter Web Interface | 68 |
| 64 | Server Parameter Telnet Interface | 68 |
| 65 | Wireless Parameter | 70 |
| 66 | Wireless Encryption Modes | 71 |
| 67 | OpenVPN Network Parameter | 72 |
| 68 | viaVPN Network Parameter | 74 |
| 69 | Node-RED Parameter | 75 |
| 70 | Modbus/TCP Network Parameter | 76 |
| 71 | Access Authentication | 77 |
| 72 | Date & Time Retrieval Options | 78 |
| 73 | Port Page Selection in Web Browser | 79 |
| 74 | Port Selection in Telnet | 79 |
| 75 | Serial Settings | 80 |
| 76 | Operation Mode by Software | 80 |
| 77 | Advanced Flow Control | 81 |
| 78 | Serial Port Mode Selection | 82 |
| 79 | Driver Mode parameters | 83 |
| 80 | TCP Raw Server parameters | 84 |
| 81 | TCP Raw Client parameters | 85 |
| 82 | Null Modem Tunnel | 86 |
| 83 | TCP Advanced Settings | 88 |
| 84 | UDP Data Transfer | 89 |
| 85 | IP-Modem | 90 |
| 86 | Print Server Configuration | 92 |
| 87 | Ping and Response in Web Browser | 93 |
| 88 | Ping and Response in Telnet | 94 |
| 89 | Statistics Port Selection | 94 |
| 90 | Port Statistics | 95 |
| 91 | Start Netstat | 95 |
| 92 | Netstat Sample Output | 96 |
| 93 | WLAN Scan | 97 |
| 94 | WLAN Scan Output | 97 |
| 95 | Firmware Upload | 98 |
| 96 | Save and Load Configuration in Web Browser | 99 |
| 97 | Syslog & Debuglog Parameters | 99 |
| 98 | Menu Save modified Parameters in Telnet | 100 |
| 99 | Menu Exit from Configuration in Telnet | 101 |
| 100 | Exit and Reboot in Telnet | 101 |
| 101 | Add a printer | 115 |
| 102 | Select Printer Port | 115 |
| 103 | Create Printer Port | 116 |
| 104 | Name-Properties of Print Server Port | 116 |
| 105 | Mode-Properties of Print Server Port | 117 |

| | | |
|-----|-----------------------------------|-----|
| 106 | Select Port for Printer | 118 |
| 107 | Add Printer Port | 118 |
| 108 | OpenVPN Installation Wizard | 119 |
| 109 | OpenVPN Installable Components | 119 |
| 110 | Installing TAP-Win32 Adapter | 120 |
| 111 | OpenVPN Network Adapter | 120 |
| 112 | OpenVPN Client Configuration File | 121 |
| 113 | OpenVPN Server Configuration File | 122 |
| 114 | Context-Menu of OpenVPN™ | 124 |
| 115 | OpenVPN Connection is active | 124 |
| 116 | OpenVPN by Command line | 125 |
| 117 | OpenVPN as Windows Service | 125 |
| 118 | Start OpenVPN Service | 126 |
| 119 | Service Options | 126 |
| 120 | Startup Types | 126 |
| 121 | viaVPN activation | 129 |
| 122 | viaVPN Network Parameter (web) | 129 |
| 123 | Front Side | 135 |
| 124 | Left and Right Sides | 136 |
| 125 | Rear Side | 137 |
| 126 | Bottom Side | 137 |
| 127 | Top Part | 138 |
| 128 | Front and Rear Sides | 139 |
| 129 | Bottom Side | 140 |
| 130 | Rackmount (Angled) Bracket | 140 |
| 131 | Wallmount Plates (WK-NCP) | 141 |

List of Tables

| | | |
|----|---|----|
| 1 | Specifications, common | 14 |
| 2 | Characteristics of NetCom Plus 111 | 14 |
| 3 | Characteristics of NetCom Plus 113 | 15 |
| 4 | Characteristics of NetCom Plus 111 Mini | 16 |
| 5 | Characteristics of NetCom Plus 113 Mini | 16 |
| 6 | Characteristics of NetCom Plus 211 | 17 |
| 7 | Characteristics of NetCom Plus 213 | 17 |
| 8 | Characteristics of NetCom Plus 411 | 18 |
| 9 | Characteristics of NetCom Plus 411 POE | 18 |
| 10 | Characteristics of NetCom Plus 413 | 18 |
| 11 | Characteristics of NetCom Plus 413 POE | 19 |
| 12 | Characteristics of NetCom Plus 811 | 20 |
| 13 | Characteristics of NetCom Plus 811 POE | 20 |
| 14 | Characteristics of NetCom Plus 813 | 21 |
| 15 | Characteristics of NetCom Plus 813 POE | 21 |
| 16 | Characteristics of NetCom Plus 811 DIO | 22 |
| 17 | Characteristics of NetCom Plus 1613 | 24 |
| 18 | DIP Switches | 26 |
| 19 | Signal Assignment DSub-9 male | 27 |

| | | |
|----|---|-----|
| 20 | LED Function | 30 |
| 21 | SOHO Firewall Pass-Through | 58 |
| 22 | IP Modem cable | 105 |
| 23 | IP Modem Standard AT-Commands | 106 |
| 24 | IP Modem Extended AT-Commands | 106 |
| 25 | IP Modem S-Registers for Configuration | 107 |
| 26 | IP Modem Sample Dials | 108 |
| 27 | IP Modem virtual Modulation | 109 |
| 28 | IP Modem Responses | 109 |
| 29 | IP Modem Information Responses | 110 |
| 30 | IP Modem DTR Configuration | 111 |
| 31 | Ready LED with viaVPN | 130 |
| 32 | Function Codes Modbus/TCP for Digital-I/O | 131 |
| 33 | Mapping Modbus addresses to Input-/Output-signals | 131 |

1 Overview

The NetCom Plus Serial Device Servers are designed to remotely operate serial ports over networks. The network interface is implemented as a modern Fast Ethernet with Auto-MDI(X). The subfamily of NetCom Plus with WLAN option Serial Device Servers provide a second network interface for WLAN (as of 802.11 b/g/n) with up to 150 Mbit/s transfer rate. The subfamily of NetCom Plus POE Serial Device Servers may use power supply by Power-over-Ethernet function, as an alternative to a standard DC supply.

The data transport is implemented via TCP/IP and UDP protocols. Therefore control is available via WLAN, Ethernet, Intranet and Internet. All communication with the NetCom Plus Servers may happen encrypted by SSL on all interfaces.

The supplied driver software implements virtual serial ports, which hide the network transfer from your applications. Software applications using standard COM ports need no change to operate via NetCom Plus through the virtual serial ports.

The NetCom Plus Serial Device Servers are also referred to as “NetCom⁺” for brevity. This abbreviation is used in this manual, when the description of a function or property is more general.

2 Introduction

This manual covers several different models of NetCom Plus devices. In general the operation is the same on all models, except where explicitly noted otherwise. All models are available with an option for Wireless LAN.

The devices come with a steel case well suited for industrial environments.

The NetCom Plus support high serial speeds up to or possibly above 3 Mbps. All serial ports provide communication via the common RS232 mode (up to 1000 kbps). They also offer the industrial RS422 and RS485 configuration (up to 3.0 or 3.7 Mbps). In RS485 mode the NetCom⁺ will use the Automatic Receive Transmit (ART) control logic to follow the RS485 specifications for transmitting data. No special code for data direction is necessary to be implemented in your software applications.

Applications requiring RS232 only are in widespread use. For ease of configuration several models of NetCom Plus only support this serial operation. The names of these models end with an ‘11’.¹

2.1 About this Manual

This manual covers many configuration options of the NetCom Plus Serial Device Servers. The vast majority of these are set by software, sometimes in alternative methods. To emphasize these in the text, special character styles are used.

- | | |
|------------------------|--|
| Bold Typewriter | is used for the names of configuration options or buttons, as they are displayed in menus or dialogs. |
| Typewriter | denotes names of special values for multiple-choice parameters. Such values may appear in drop-down lists or as radio buttons. |

The version of the firmware described in this manual is 3.4.8, covered together with driver 2.0.3.0.

¹NetCom Plus 111 (Mini) / 211 / 411 (POE) / 811 (POE/DIO)

2.2 Features

- Single power supply NetCom Plus single and dual port models
DC 12-48V, 300 mA@12V
- Single power supply NetCom Plus four port and up models
DC 9-54V, 800 mA@12V
- Single power supply NetCom Plus 111 Mini
DC 9-30V, 90 mA@12V
- Double power supply NetCom Plus POE POE models
DC 15-54V, 800 mA@15V
Power over Ethernet 802.3af Class 0
- Wireless LAN 802.11 b/g/n for 150Mbit/s as an option
- Fast Ethernet 100/10 Mbps with Auto-MDI(X) for auto-configuration
- Three way serial port interfaces: RS232/RS422/RS485
- USB 2.0 port for Expansion of serial ports via USB-COM Plus modules
- Max. 3.0/3.7 Mbps, half- and full-duplex
- TCP/IP configuration fixed or by DHCP
- Easy remote configuration via SNMP
- Drivers for Windows™ operating systems
- Documented interface for every networked operating system

2.3 Product Specifications

Most of the hardware characteristics are common for all models. However some must differ from model to model, they are shown in dedicated sections. Some models are restricted to RS232, others do have a POE supply.

Most models provide an USB 2.0 high-speed port. This may be used for a USB WLAN adapter or to add more serial ports via USB-COM Plus modules². The modules provide USB-through function to add even more ports, in total there may be 16 ports.

²USB-COM Plus modules on VScom.de

2.3.1 Common characteristics

| | | | |
|---------------------|---|--|---|
| Hardware | Modern ARM processor | | |
| WLAN antenna | SMA-reverse (optional) | | |
| Ethernet connector | RJ45 1000Base-T/100BaseTx/10BaseT | | |
| Protocols | TCP/IP, UDP, SNMP, DHCP, ICMP, ARP, Telnet, RTelnet, HTTP | | |
| Serial Speed | 180 bps up to 3.0 or 3.7 Mbps ¹ | | |
| Parity | None, Even, Odd, Mark, Space | | |
| Data bits | 7, 8 | | |
| Stop bits | 1, 2 | | |
| Serial signals | RS232 | TxD, RxD, RTS, CTS, DTR, DSR, DCD, GND | |
| | RS422 | Tx+/Tx-, Rx+/Rx-, GND | |
| | RS485 4-wire | | |
| | RS485 2-wire | Data+/Data-, GND | |
| Serial connector | DSub9 male (similar to PC) | | |
| Serial operation | RS232, RS422/485 configured by DIP switch or by software | PWR | Red Power, blinks once when ready for operation |
| LED | Wifi / WLAN | Blue | If Wireless LAN is available |
| | RDY | Green | Lights when ready for operation |
| Management | Serial console, Telnet, Web browser, SNMP | | |
| Driver software | Windows 10/8.1/8/7/2008/Vista/2003/XP | | |
| Management software | Driver installation and configuration program, Management console | | |
| Operating temp. | 0° to 65°C | | |
| Approval | CE, FCC | | |

Table 1: Specifications, common

Note 1: Serial bitrates above 500 kbps may cause problems when used with RS232. It requires short cables with low capacity, to reduce load on the serial signals. When using RS422/485 there is no problem using maximum bitrates.

2.3.2 Device specific Characteristics

2.3.2.1 NetCom Plus 111 One Port.

| | |
|-------------------|---------------------------------|
| Power Requirement | DC 12V to 48V, 250 mA@12V |
| Power Connector | Terminal Block (3.7.1) |
| Serial Ports | 1×RS232 |
| Serial Speed | 180 bps up to 1.0 Mbps |
| Data bits | 5, 6, 7, 8 |
| USB Port | For Expansion of Ports and WLAN |
| Dimensions | 115×73×25 mm (W×D×H) |
| Weight | 400 g |

Table 2: Characteristics of NetCom Plus 111

2.3.2.2 NetCom Plus 113 One Port.

| | |
|-------------------|---------------------------------|
| Power Requirement | DC 12V to 48V, 250 mA@12V |
| Power Connector | Terminal Block (3.7.1) |
| Serial Ports | 1×RS232/RS422/RS485 |
| Serial Speed | 180 bps up to 3.7 Mbps |
| Data bits | 5, 6, 7, 8 |
| USB Port | For Expansion of Ports and WLAN |
| Dimensions | 115×73×25 mm (W×D×H) |
| Weight | 400 g |

Table 3: Characteristics of NetCom Plus 113



Figure 1: NetCom Plus 111 / 113

The NetCom Plus 111 and the NetCom Plus 113 look the same on the front side. Here are the connectors for Ethernet, USB 2.0, LEDs and the serial port. The rear side holds the power connector, Reset button and the configuration switches. Positions for WLAN antenna are built-in.

The port of USB 2.0 supports USB-COM Plus and USB-2COM Plus modules, either standard or galvanically isolated.

2.3.2.3 NetCom Plus 111 Mini One Port. (*This model is phased out*)

| | |
|-------------------|---|
| Power Requirement | DC 9V to 30V, 90 mA@12V |
| Power Connector | 2 clamp Terminal Block (3.7.2) |
| Serial Ports | 1×RS232 |
| Serial Speed | 180 bps up to 500 kbps |
| Data bits | 7, 8 |
| Dimensions | 50×72×22 mm (W×D×H) 72×72×22 mm with Mounting Ears |
| Weight | 150 g |

Table 4: Characteristics of NetCom Plus 111 Mini

2.3.2.4 NetCom Plus 113 Mini One Port. (*This model is phased out*)

| | |
|-------------------|---|
| Power Requirement | DC 9V to 30V, 90 mA@12V |
| Power Connector | 2 clamp Terminal Block (3.7.2) |
| Serial Ports | 1×RS232/RS422/RS485 |
| Serial Speed | 180 bps up to 3.0 Mbps |
| Data bits | 7, 8 |
| Dimensions | 50×72×22 mm (W×D×H) 72×72×22 mm with Mounting Ears |
| Weight | 150 g |

Table 5: Characteristics of NetCom Plus 113 Mini

The NetCom Plus Mini models are compact versions of the NetCom Plus 111/113, therefore the functions are very similar. The Mini models allow for different ways of mounting, and occupy less space. They are especially designed for very low power consumption.



Figure 2: NetCom Plus 111/113 Mini

On NetCom Plus Mini one side has the serial connector, the opposite side holds the power connector, Reset button and the Ethernet port. The configuration switches have their place on the bottom side, while the LEDs are on the top. The LEDs for TxD and RxD are combined, they shine in green and orange simultaneously.

Note: the configuration switches are black on this model.

2.3.2.5 NetCom Plus 211 Two Ports.

| | |
|-------------------|---------------------------------|
| Power Requirement | DC 12V to 48V, 250 mA@12V |
| Power Connector | Terminal Block (3.7.1) |
| Serial Ports | 2×RS232 |
| Serial Speed | 180 bps up to 1.0 Mbps |
| Data bits | 5, 6, 7, 8 |
| USB Port | For Expansion of Ports and WLAN |
| Dimensions | 115×73×25 mm (W×D×H) |
| Weight | 400 g |

Table 6: Characteristics of NetCom Plus 211

2.3.2.6 NetCom Plus 213 Two Ports.

| | |
|-------------------|---------------------------------|
| Power Requirement | DC 12V to 48V, 250 mA@12V |
| Power Connector | Terminal Block (3.7.1) |
| Serial Ports | 2×RS232/RS422/RS485 |
| Serial Speed | 180 bps up to 3.7 Mbps |
| Data bits | 5, 6, 7, 8 |
| USB Port | For Expansion of Ports and WLAN |
| Dimensions | 115×73×25 mm (W×D×H) |
| Weight | 400 g |

Table 7: Characteristics of NetCom Plus 213



(a) Top, Front and Left Side



(b) Rear Side

Figure 3: NetCom Plus 213 Top, Front, Left and Back Side

The NetCom Plus 211 and the NetCom Plus 213 look the same on the front side. Here are the connectors for Ethernet, USB 2.0, LEDs and the serial ports. The rear side holds the power

connector, Reset button and the configuration switches. DIN Rail mounting clamp is fixed here. Positions for WLAN antenna are built-in.

The port of USB 2.0 supports USB-COM Plus and USB-2COM Plus modules, either standard or galvanically isolated.

2.3.2.7 NetCom Plus 411 Four Ports.

| | |
|-------------------|---------------------------------|
| Power Requirement | DC 9V to 54V, 500 mA@12V |
| Power Connector | Terminal Block (3.7.1) |
| Serial Ports | 4×RS232 |
| Serial Speed | 180 bps up to 1.0 Mbps |
| Data bits | 7, 8 |
| USB Port | For Expansion of Ports and WLAN |
| Dimensions | 196×147×44 mm (W×D×H) |
| Weight | 900 g |

Table 8: Characteristics of NetCom Plus 411

2.3.2.8 NetCom Plus 411 POE Four Ports.

| | |
|-------------------|--|
| Power Requirement | DC 15V to 54V, 600 mA@15V (DC 15V to 54V on some samples) |
| Power Connector | Terminal Block (3.7.1) |
| Power Alternative | Power over Ethernet PoE 802.3af Class 0 |
| Serial Ports | 4×RS232 |
| Serial Speed | 180 bps up to 500 kbps |
| Data bits | 7, 8 |
| Dimensions | 196×147×44 mm (W×D×H) |
| Weight | 900 g |

Table 9: Characteristics of NetCom Plus 411 POE

Note: RDY (Ready) LED is blue

2.3.2.9 NetCom Plus 413 Four Ports.

| | |
|-------------------|--|
| Power Requirement | DC 9V to 54V, 500 mA@12V |
| Power Connector | Terminal Block (3.7.1) |
| mPCIe Slot | Optional, for 3G/4G modems |
| LED | 3G Orange If mobile network is available |
| Serial Ports | 4×RS232/RS422/RS485 |
| Serial Speed | 180 bps up to 3.0 Mbps |
| Data bits | 7, 8 |
| USB Port | For Expansion of Ports and WLAN |
| Dimensions | 196×147×44 mm (W×D×H) |
| Weight | 900 g |

Table 10: Characteristics of NetCom Plus 413

2.3.2.10 NetCom Plus 413 POE Four Ports.

| | |
|-------------------|---|
| Power Requirement | DC 9V to 54V, 600 mA@15V (DC 15V to 54V on some samples) |
| Power Connector | Terminal Block (3.7.1) |
| Power Alternative | Power over Ethernet PoE 802.3af Class 0 |
| mPCIe Slot | Optional, for 3G/4G modems |
| LED | 3G Orange If mobile network is available |
| Serial Ports | 4×RS232/RS422/RS485 |
| Serial Speed | 180 bps up to 3.0 Mbps |
| Data bits | 7, 8 |
| USB Port | For Expansion of Ports and WLAN |
| Dimensions | 196×147×44 mm (W×D×H) |
| Weight | 900 g |

Table 11: Characteristics of NetCom Plus 413 POE



Figure 4: NetCom Plus 411 / 413 Front side



Figure 5: NetCom Plus 411 / 413 / 413 POE Rear side



Figure 6: NetCom Plus 411 POE Rear side

All models with four serial ports look the same on the front side. This side has the connectors for Ethernet and the serial ports, plus the LEDs. Also here is a plastic cap hiding the position for a WLAN antenna. The rear side holds the power connector, Reset button and the configuration switches. Except for NetCom Plus 411 POE there is also the USB 2.0 expansion port. The two holes for screws may be used as additional contacts for Protective Earth.

The port of USB 2.0 supports expansion with all modules from USB-COM Plus model up to USB-8COM Plus, in either standard or galvanically isolated variant.

2.3.2.11 NetCom Plus 811 Eight Ports.

| | |
|-------------------|---------------------------------|
| Power Requirement | DC 9V to 54V, 500 mA@12V |
| Power Connector | Terminal Block (3.7.1) |
| Serial Ports | 8×RS232 |
| Serial Speed | 180 bps up to 1.0 Mbps |
| Data bits | 7, 8 |
| USB Port | For Expansion of Ports and WLAN |
| Dimensions | 196×147×44 mm (W×D×H) |
| Weight | 900 g |

Table 12: Characteristics of NetCom Plus 811

2.3.2.12 NetCom Plus 811 POE Eight Ports.

| | |
|-------------------|---|
| Power Requirement | DC 15V to 54V, 800 mA@15V |
| Power Connector | Terminal Block (3.7.1) |
| Power Alternative | Power over Ethernet PoE 802.3af Class 0 |
| Serial Ports | 8×RS232 |
| Serial Speed | 180 bps up to 500 kbps |
| Data bits | 7, 8 |
| Dimensions | 196×147×44 mm (W×D×H) |
| Weight | 900 g |

Table 13: Characteristics of NetCom Plus 811 POE

Note: RDY (Ready) LED is blue

2.3.2.13 NetCom Plus 813 Eight Ports.

| | |
|-------------------|--|
| Power Requirement | DC 9V to 54V, 500 mA@12V |
| Power Connector | Terminal Block (3.7.1) |
| mPCIe Slot | Optional, for 3G/4G modems |
| LED | 3G Orange If mobile network is available |
| Serial Ports | 8×RS232/RS422/RS485 |
| Serial Speed | 180 bps up to 3.0 Mbps |
| Data bits | 7, 8 |
| USB Port | For Expansion of Ports and WLAN |
| Dimensions | 196×147×44 mm (W×D×H) |
| Weight | 900 g |

Table 14: Characteristics of NetCom Plus 813

2.3.2.14 NetCom Plus 813 POE Eight Ports.

| | |
|-------------------|--|
| Power Requirement | DC 9V to 54V, 800 mA@15V |
| Power Connector | Terminal Block (3.7.1) |
| Power Alternative | Power over Ethernet PoE 802.3af Class 0 |
| mPCIe Slot | Optional, for 3G/4G modems |
| LED | 3G Orange If mobile network is available |
| Serial Ports | 8×RS232/RS422/RS485 |
| Serial Speed | 180 bps up to 3.0 Mbps |
| Data bits | 7, 8 |
| USB Port | For Expansion of Ports and WLAN |
| Dimensions | 196×147×44 mm (W×D×H) |
| Weight | 900 g |

Table 15: Characteristics of NetCom Plus 813 POE



Figure 7: NetCom Plus 811 / 813 Front side



Figure 8: NetCom Plus 811 / 813 / 813 POE Rear side



Figure 9: NetCom Plus 811 POE Rear side

The above models with eight serial ports look the same on the front side. This side has the connectors for Ethernet and the serial ports, plus the LEDs. Also here is a plastic cap hiding the position for a WLAN antenna. The rear side holds the power connector, Reset button and the configuration switches. Except for NetCom Plus 811 POE there is also the USB 2.0 expansion port. The two holes for screws may be used as additional contacts for Protective Earth.

The port of USB 2.0 supports expansion with all modules from USB-COM Plus model up to USB-8COM Plus, in either standard or galvanically isolated variant.

2.3.2.15 NetCom Plus 811 DIO Eight Serial Ports, 8 Digital Input and 8 Digital Output.

| | |
|-------------------|---|
| Power Requirement | DC 15V to 54V, 800 mA@15V |
| Power Connector | Terminal Block (3.7.1) |
| Power Alternative | Power over Ethernet PoE 802.3af Class 0 |
| Serial Ports | 8×RS232 |
| Serial Speed | 180 bps up to 500 kbps |
| Data bits | 7, 8 |
| Digital Inputs | 8× wet input (5V) optically isolated |
| Digital Outputs | 8× relay output (contacts for normal open / closed) |
| Dimensions | 196×147×44 mm (W×D×H) |
| Weight | 900 g |

Table 16: Characteristics of NetCom Plus 811 DIO

Note: *This model is phased out and no longer available for sale.*



(a) NetCom Plus 811 DIO Front side

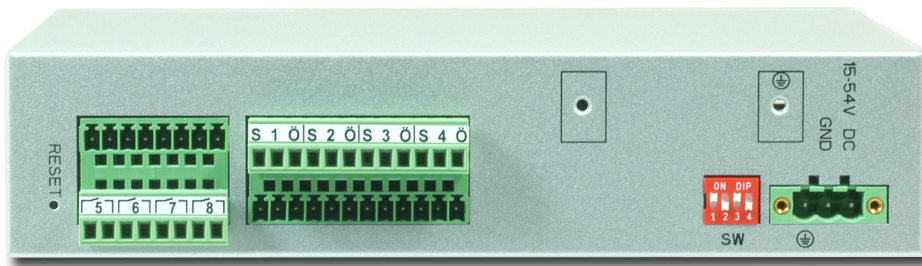

(b) NetCom Plus 811 DIO Rear side

Figure 10: NetCom Plus 811 DIO

The NetCom Plus 811 DIO looks the same on the front side, as all the other models with eight serial ports. Here are the connectors for Ethernet and the serial ports, plus the LEDs and the plastic cap hiding the position for a WLAN antenna. The rear side holds the power connector, Reset button, configuration switches and connectors for terminal blocks used with input and output signals. The terminal block clamps are plug-in, so here each side is shown with one socket plugged and the other open. The two holes for screws may either hold a fixture for cable straps, to guide the wires for digital I/O contacts. Or they may serve as an additional contact for Protective Earth.

Note: RDY (Ready) LED is blue

2.3.2.16 NetCom Plus 1613 Sixteen Ports.

This product is a bundle of NetCom Plus 813 and an USB-8COM Plus extension module. The module is set to allow serial port configuration by software. Both devices are put together using a special Rack Mount Kit, so they use one unit of height in a 19-inch cabinet.

| | |
|-------------------|--|
| Power Requirement | DC 9V to 54V, 800 mA@12V |
| Power Connector | Terminal Block (3.7.1) |
| mPCIe Slot | Optional, for 3G/4G modems |
| LED | 3G Orange If mobile network is available |
| Serial Ports | 16×RS232/RS422/RS485 |
| Serial Speed | 180 bps up to 3.0 Mbps |
| Data bits | 7, 8 |
| USB Port | For Expansion with WLAN |
| Dimensions | 437×147×44 mm (W×D×H) |
| Weight | 1900 g |

Table 17: Characteristics of NetCom Plus 1613



(a) 19-Inch mounted complete



(b) Left part in Detail



(c) Details for Right part

Figure 11: NetCom Plus 1613

Both modules may share one power supply adapter. Since the number of supported serial ports is already used up, the port of USB 2.0 on the USB-8COM Plus supports extension with WLAN only.

2.4 Packing List

- NetCom Plus or NetCom Plus POE Serial Device Server
- WLAN Antenna with WLAN option
- Mounting angles and wall mount plates for 19" models
- Terminal Block connector for DC power supply
- Terminal Block connectors for Input/Output on NetCom Plus 811 DIO

2.4.1 **Warning:**

The packages of NetCom Plus 19-inch models include a Wall Mount Kit. There are two sets of screws in the package, long screws and short screws. The short screws are designed to fix the Wall Mount Kit. The long screws are intended to fix the 19-inch mounting brackets to the case. **These long screws *must not* be used on the Wall Mount Kit, otherwise this may result in damage of the device.**

3 Hardware Description

This section focuses on the options provided by the hardware of NetCom Plus Serial Device Servers.

3.1 Serial Port Configuration

The serial ports in the NetCom⁺ Devices follow the specifications of RS232. On many models it is also possible to use the serial ports in RS422 or RS485 mode. This is defined by a set of DIP switches or by software. Here is a list of the available modes and the switch settings. Table 18a shows the DIP positions. The light end is the position where the switch is pushed to.

Warning: a bad configuration may cause serious damage in the NetCom⁺ or the connected device.

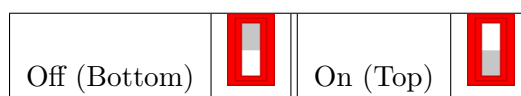

(a) DIP Switch Description

| | Line Mode, Comment | S1 | S2 | S3 | S4 | Switch Positions |
|----------------------|--|-----|-----|-----|-----|------------------|
| | Configuration via Serial Port ¹ | Off | Off | Off | Off | |
| | Factory Settings ² | Off | Off | Off | On | |
| | Selected by Software ³ | Off | Off | On | On | |
| RS232 | Operation | On | Off | Off | Off | |
| RS422 ⁴ | 4-wire Operation | On | Off | On | Off | |
| | 4-wire with Rx-Termination | On | Off | On | On | |
| RS485 ^{4,5} | 4-wire Operation | On | On | On | Off | |
| | 4-wire with Rx-Termination | On | On | On | On | |
| | 2-wire Operation | On | On | Off | Off | |
| | 2-wire with Termination | On | On | Off | On | |

(b) DIP Switch Configurations

Table 18: DIP Switches

- Note 1: »Configuration via Serial Port« is only effective on port 1 of the NetCom⁺ Server.
- Note 2: Factory Settings are restored on Power-Up/Reset of the NetCom⁺.
- Note 3: The Master DIP switches configure all serial ports of a NetCom⁺ to a common operation mode. If diversity in line operation modes is intended, the switch must be set to »Selected by Software«, and the configuration may be done via Serial Port, Telnet, Web browser or SNMP.
- Note 4: Line operation modes of RS422 and RS485 are not available on NetCom Plus 111 / 211 / 411 / 811 (incl. POE).
- Note 5: In RS485 mode the NetCom⁺ performs the required activation and disabling of the RS485 transmitter by an internal automatic. Application software does not have to perform special operations.

USB-COM Plus modules may be added for port expansion. These are either configured by their own DIP switches. Or when the 4- and 8-port modules are set for configuration by software, the operation mode is controlled by the NetCom Plus in the same way as with the internal ports.

3.2 Serial Signal Assignment

It is of course important to know the exact location of the serial signals in the configured mode. Here is the table for the DSub-9 male connector. For RS232 the assignment is the same as on any PC (Com1/2).

| Pin | RS232 | RS422 / 485 4-wire | RS485 2-wire |
|-----|-------|--------------------|--------------|
| 1 | DCD | Tx- (A) | Data- (A) |
| 2 | RxD | Tx+ (B) | Data+ (B) |
| 3 | TxD | Rx+ (B) | |
| 4 | DTR | Rx- (A) | |
| 5 | GND | GND | GND |
| 6 | DSR | | |
| 7 | RTS | | |
| 8 | CTS | | |
| 9 | RI | | |

Table 19: Signal Assignment DSub-9 male

Please note the GND signal in RS422 and RS485 modes. This signal must also be connected between the serial devices. So in reality there is neither a 2-wire nor a 4-wire connection. With the exception of very special configurations, a serial cable without GND violates the specifications for RS 422 and RS485. Signal RI is only available in RS232 mode on NetCom Plus 111 / 113 / 211 / 213.

On USB-COM Plus modules used for Port Expansion the signal assignment is the same as on NetCom Plus. Also signal RI is only available with one and two ports.

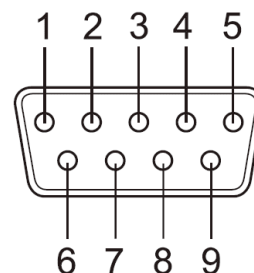

Figure 12: Connector DSub-9 male

3.3 RS422/485 Electrical Configuration

In typical RS422 and RS485 installations certain electric conditions have to be configured. Simply connecting cables is not enough to fulfill the specifications of RS422 and RS485.

For ease of installations the NetCom Plus Serial Device Servers provide the function for often used Termination. This is activated by selecting the appropriate line operation mode via DIP Switches (table 18) or by software.

The electrical properties of USB-COM Plus serial ports are identical.

3.3.1 Termination Resistors

The use of long communication lines in RS422 and RS485 mode requires the installation of termination resistors. These must match the impedance of the cable. Typical cables in Twisted-Pair configuration have an impedance of about 120Ω . In RS422 and RS485 4-wire this resistor has to be placed at the end(s) far from the sender, in RS485 2-wire the typical configuration requires one resistor at each end of the cable.

The NetCom Plus Serial Device Servers provide a suitable termination resistor integrated in the line drivers, activation is done by selecting the appropriate operation mode.

For values of impedance other than 120Ω the resistors have to be installed directly on the cable.

3.3.2 BIAS Function

RS485 requires a BIAS option for the communication lines. This will guarantee stable electrical levels on the cables, even at times when no station is transmitting data. Without BIAS there will be noise on the cable, and sometimes receivers can not detect the first characters of a beginning communication.

The NetCom Plus Serial Device Servers do not need an explicit BIAS function. With termination active the idle state of the transmission line is at 0V, which is recognized as a positive level (logic one) in the receiver circuit. Other devices may require explicit BIAS for a higher voltage at idle state, e.g. 100mV. In such situation attach that function directly to the cable.

3.4 Serial Port Simple Settings

There is one set of 4 DIP switches to configure the operation mode of the NetCom Plus Device. This switch is the Master configuration for each serial port. All ports operate in the same mode, unless the DIP switches configure for software setting. Before connecting a serial device, the serial port configuration must be completed.

Warning: a bad configuration may cause serious damage in the NetCom⁺ or the connected device. To avoid these problems, it is recommended not to connect a device to the serial ports in the first installation. The serial ports should be configured for RS232. This is done by setting the DIP switches like this example.

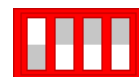

Figure 13: DIP NetCom Plus

3.5 Digital Input/Output

This function is only available on NetCom Plus 811 DIO. The input signals are optically isolated from the system, and output function is realized by relay.

3.5.1 Input Connection

The input uses a wet contact. There are two connector clamps per input signal, each pair marked by the number from 1 to 8. The symbol around the numbers represents a push button to connect both clamps together. The right clamp provides a voltage of roughly 5V at low current. When this supply is connected to the left clamp, the input signal changes status. Usually such is done using a push button or a switch, but a relay output will also do quite fine.



Figure 14: Terminal Block Input

3.5.2 Output Connection

The output is controlled by a relay, providing three clamps on the Terminal Block. The center clamp is the common signal, and marked by the number from 1 to 8. By default (system is off, or output is set as logic One) the relay connects the common signal to the right clamped marked with the letter 'Ö'. When the relay is programmed to logic Zero, the connection to the right clamp is interrupted, instead the common signal connects to the left clamp marked with the letter 'S'. These relay control either 2 A at 30V DC, or 0.5 A at 125VAC.



Figure 15: Terminal Block Output

3.6 Network

The NetCom Plus and NetCom Plus POE connect to Ethernet, while the NetCom Plus with WLAN option may use either WLAN or Ethernet at customers choice. By factory settings both interfaces are enabled, and the priority is set for Ethernet (i.e. via cable). If no cable is connected here, the Wireless interface is active. Otherwise the server communicates via Ethernet. Both interfaces use the same MAC Address and IP Address, to allow for seamless switch-over from cable to wireless operation. The NetCom Plus with WLAN option Servers do not perform a DHCP request when the WLAN interface becomes active.

3.6.1 Ethernet and LED

The connector for Ethernet is the usual RJ45. Simply connect it to your (switching) Hub. Because the Gigabit Ethernet has Auto-MDI(X) function, a direct cable or a cross-over cable may both be used.

When the connect is done the Link LED on NetCom Plus (orange) will light. When data traffic occurs on the network, this LED will blink. It depends on your network whether a 100/10 Mbit or a 1000 Mbit connect will be established. A 100/10 Mbit net causes the Speed LED on NetCom Plus (green) to light, with 1000 Mbit it will remain dark.

| Red LED | Orange LED | Green LED | Status |
|---------|------------|-----------|-------------------------------------|
| Off | – | – | Device off, no power |
| On | Off | Off | No connection |
| On | On | Off | 1000 Mbit connection established |
| On | Blink | Off | 1000 Mbit data transfer (traffic) |
| On | On | On | 100/10 Mbit connection established |
| On | Blink | On | 100/10 Mbit data transfer (traffic) |

Table 20: LED Function

When the firmware is completely started, the NetCom Plus becomes operational. This is shown to the user by two events: The LED for power (red) shortly blinks, i.e. it is Off and then On again. At the same time the Ready LED (RDY, green) lights and stays On.

3.6.2 WLAN Configuration

The pre-defined operation mode of Wireless LAN is as Access Point, any computer with WLAN equipment may contact the NetCom Plus with WLAN option. The configuration of the NetCom Plus is done with the tools described later. This is the most easy way of installation.

However the pre-defined configuration is not encrypted. As one result any station can read the data transferred to the NetCom Plus via WLAN, this also includes the passwords. Therefore the recommended method is to use the Ethernet connector for the first configuration. Or in case of doubt, use the first serial port to configure the NetCom Plus.

The configuration of the WLAN parameters should follow in a later step. This is especially the case, if encryption or certain other parameters require special configuration.

The parameter configuration of WLAN is the same for the internal WLAN Kit and a supported external adapter.

3.6.3 WLAN Antenna

The connector used for the WLAN Antenna is known as SMA-Reverse. This is a standard type to allow for simple connection of different equipment. Just fit the supplied antenna by carefully screwing it to the connector. You are free to connect a cable and a different antenna of your choice, as long as it is designed for WLAN.

3.6.4 WLAN LED

In WEP mode the Blue LED for WLAN lights if the NetCom Plus detects an operational WLAN it can connect to. In WPA mode the Blue LED lights when the NetCom⁺ successfully connected to a WLAN. And of course the LED lights when the NetCom⁺ operates as Access Point.

3.7 Power Supply

The NetCom Plus devices are powered by a single 9-54V power supply. It requires 70 mA up to 750 mA of current, depending on the device type and voltage supplied. Connect the cable to the Terminal Block at the rear side of NetCom Plus.

The NetCom Plus 411/811 POE devices are either powered by a single 15-54V power supply, in the same way as the NetCom Plus and NetCom Plus with WLAN option devices; this also applies to the NetCom Plus 811 DIO. The NetCom Plus 413/813 POE devices use the standard 9-54V supply.

Or the NetCom Plus POE devices are powered via the network cable, connected to an Ethernet switch with PoE function as IEEE 802.3af. This switch is referenced as the PSE (Power Sourcing Equipment), while the NetCom Plus POE is the PD (Powered Device). It indicates itself as a Class 0 device when sourced by the PSE. An external power adapter has priority over the PoE function.

3.7.1 Terminal Block Power

The Terminal Block power connector receives positive voltage on the right (V+) pin. The center (V-) pin receives ground voltage, and Field GND (FG) connects to the case. Connect FG to Protective Earth Rail.

In NetCom Plus and NetCom Plus with WLAN option devices the V- connects to the case. V- is isolated in the NetCom Plus 411/811 POE and NetCom Plus 811 DIO devices.

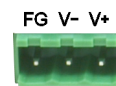

Figure 16: Power Terminal Block

3.7.2 Terminal Block Power on NetCom Plus Mini

The Terminal Block power connector for the Mini model receives positive voltage on the left (V+) pin. The right (V-) pin receives ground voltage. Connect the case to Protective Earth Rail.



Figure 17: Power Terminal Block

4 Windows Virtual COM Driver

This chapter covers the use of NetCom⁺ Devices via Virtual Com Ports installed by the supplied driver software for Windows. Sections 4.1 to 4.3 describe in details the process of driver installation and removal, as well as updating. This first part here is for quick installation, so only the common options are covered.

Section 4.4 provides the details of NetCom Plus Manager and also the options available with the Virtual Com Ports.

4.1 Installation Procedure

Before starting installation, it is essential to have an IP configuration ready for the NetCom⁺ Device to install. You may read the TCP/IP Description (section 13) below. The default configuration is based on DHCP, which is fine in many networks. If in doubt, please ask your Network Administrator for help. Further it is assumed the network access is functional. It is recommended to use Ethernet via Hub for configuration.

The following description is based on Windows 10. The installation on other configurations of Windows is similar. The installation of drivers is described first. This is followed by a procedure to verify a correct installation. The last part of this section is about the uninstall or update processes of drivers and tools.

Drivers are provided for Windows XP up to Windows 10, Windows Server 2003 up to 2008 R2. The x86 and x64 Editions have separate drivers.

The drivers use the IP Address of NetCom⁺ Servers to operate. So the configuration of the device should avoid to change that over time. This is either done via a static IP Address, or by proper configuration of the DHCP server. In the second case the DHCP server shall recognize the NetCom⁺ by its MAC Address, and assign the same IP Address each time the device sends a request. All available DHCP Server products provide such a function, even in SOHO routers.

4.1.1 Start the Installation Wizard

VSNSSETUPA64PLUS.EXE is the name of the Installation Wizard^a. The drivers with this application are available on the Internet, in the latest version. Start this program to install the drivers. The small shield in the icon is an overlay made by Windows, indicating this application requires administrative privileges to change the system configuration.

The full Installer contains both the x64 and x86 variants of the software, and decides which to install. This software is available for download.



Figure 18: Installation Wizard

^aVSNSSETUPPLUS.EXE in x86 Editions of Windows

4.1.1.1 User Account Control (UAC) In Windows OS typical configurations require to confirm the start of software to change the system configuration.

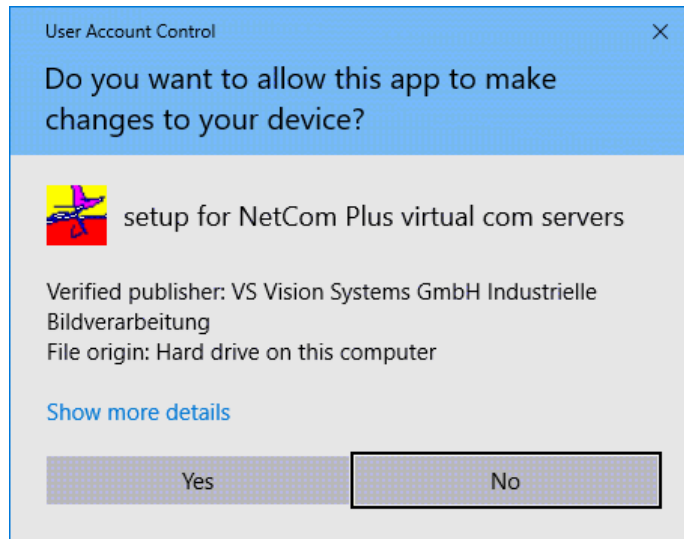

Figure 19: UAC in Windows 10 (1803)

Since a change of system configuration is intended by the driver installation, confirm to start the software.

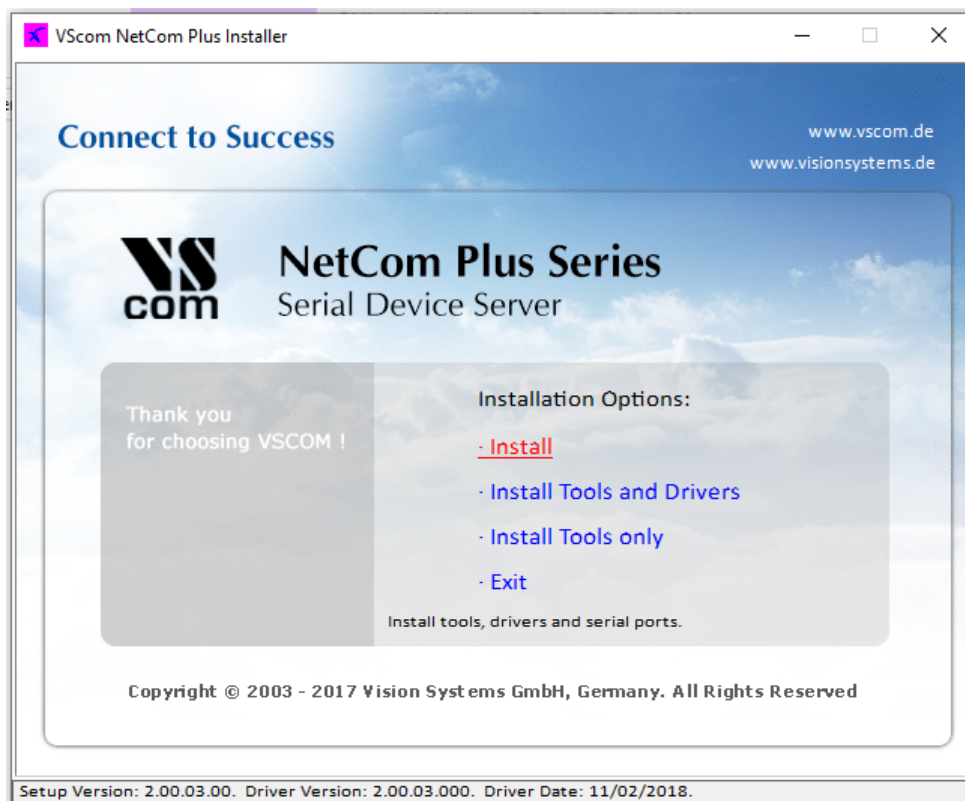

Figure 20: NetCom⁺ Driver Installation

4.1.1.2 Methods of Installation The installation program offers three different ways of installation. The first option is the most common used function to **Install** the drivers. All driver files and tools are copied to the Windows system, and installed in the Start Menu. Further the drivers are installed in the system, and the network is searched for available NetCom⁺. The serial ports on these devices are installed as Virtual Com Ports in the system.

The second option will **Install Tools and Drivers**, but not the Virtual Com Ports. The network is not searched for NetCom⁺ Devices, and of course no serial ports are installed in the system. This function is designed to prepare a computer for use of NetCom⁺ Virtual Com Ports, but the final installation shall be skipped for some reasons. For example the computer shall be shipped to a customer, and the final installation is planned to happen there.

Finally the third option is to **Install Tools only**, no drivers. At time of writing these tools are the NetCom Manager, as well as the uninstall and repair functions. This function should be selected when the use of Virtual Com Port drivers is not intended. The NetCom⁺ Devices may be used in many different operation modes covered later (6).

There are also some Hyperlinks, opening access to possibly more recent driver versions.

This part of the manual documents the **Install** option, so click this.

4.1.1.3 Proceed Installation A target folder for a file copy is requested. The tools and driver files are installed here. The tools will appear in the Start Menu, so a sub-folder of your Program Files is suggested. Just click the **OK** button.

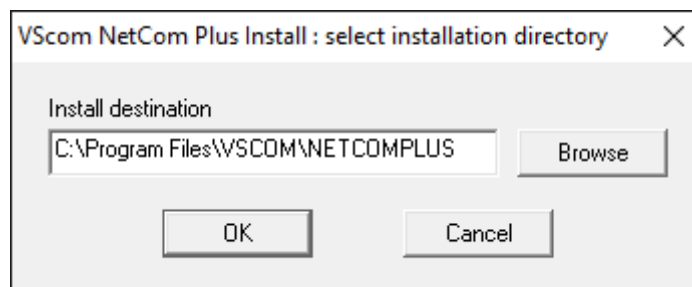

Figure 21: Start Driver Installation

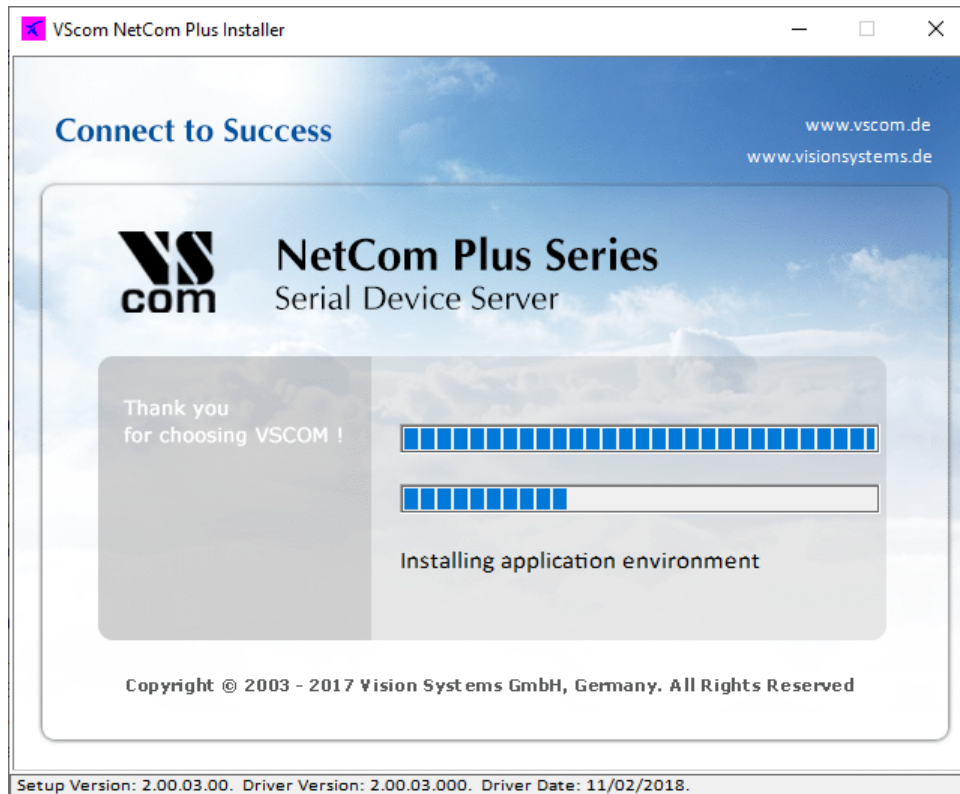

Figure 22: Copy Driver Files

Some files are copied to your hard disk, this is the usual process similar to other Windows installations. The upper bar increases with the progress of each step performed in the installation process. The lower bar illustrates each step performed until full installation is finished.

4.1.1.4 Request for Trust While copying the files, the drivers are also installed on the system. There is another request from Windows for confirmation.

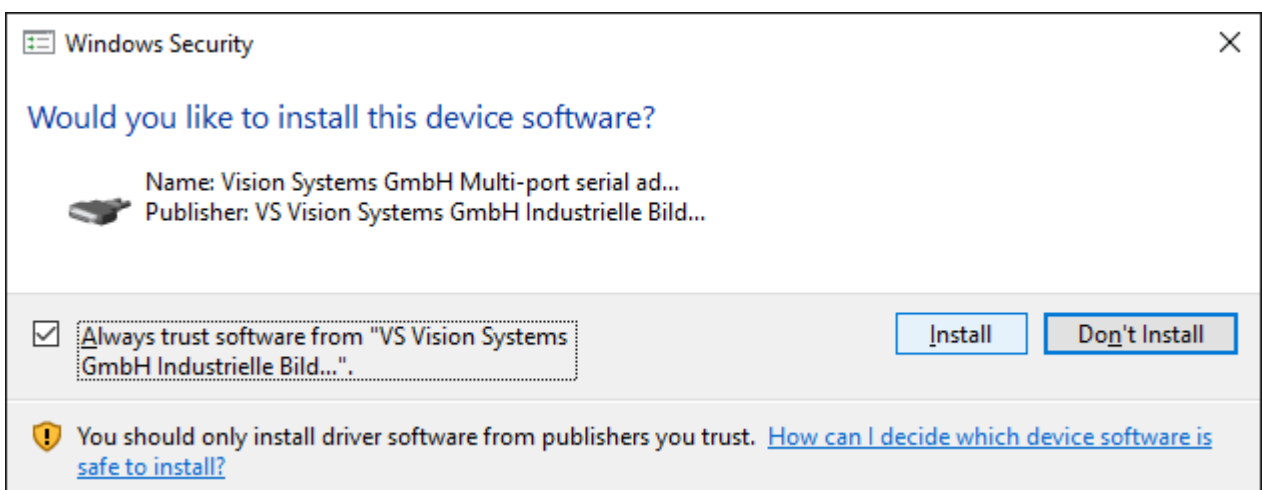

Figure 23: Install Request

Note: No component is actually installed at this moment. Windows is just preparing to load the drivers, once the NetCom Plus Manager instructs to do so. This request will come twice, to make it more easy just tick the **Always trust** option.

4.1.2 Find and Configure NetCom⁺ Devices

When all files are copied, the NetCom Plus Manager³ program is started. Since Windows 7 administrative privileges are not sufficient to perform every kind of operation on network functions. The Windows firewall requires special treatment, and the Manager asks for permission on that.

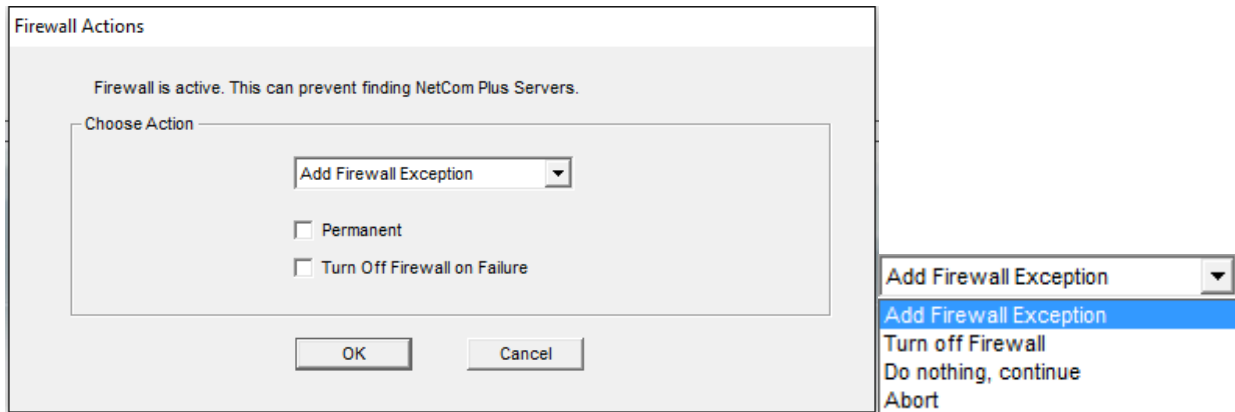

Figure 24: Firewall options

The options in drop down:

Add Firewall Exception adds a temporary entry in the firewall rules. This allows the NetCom Plus Manager to more generally receive certain messages on the network. When the Manager is finished this rule is removed.

Turn off Firewall does exactly that. The Windows Firewall is disabled completely. This should never be necessary, and is an option of last resort in case of trouble.

Do nothing, continue does nothing as suggested. It is the understanding the current configuration of IP Parameters is sufficient. However some NetCom⁺ might be missed in the search.

Abort is an option to stop the Manager from performing any action.

This request will appear on every start of the NetCom Plus Manager, and with certain operations in Windows Device Manager as well. In most installations the user will always select the same option again and again. The option named **Permanent** instructs the Manager to memorize the current selection. On the next start the selected action is performed without any request to the user.

The option **Turn Off Firewall on Failure** will disable the firewall, if the selected action results in any problems.

This Manager then searches for all NetCom⁺ Devices on your network.

³This program is covered in detail in 4.4. For now follow the minimum steps.

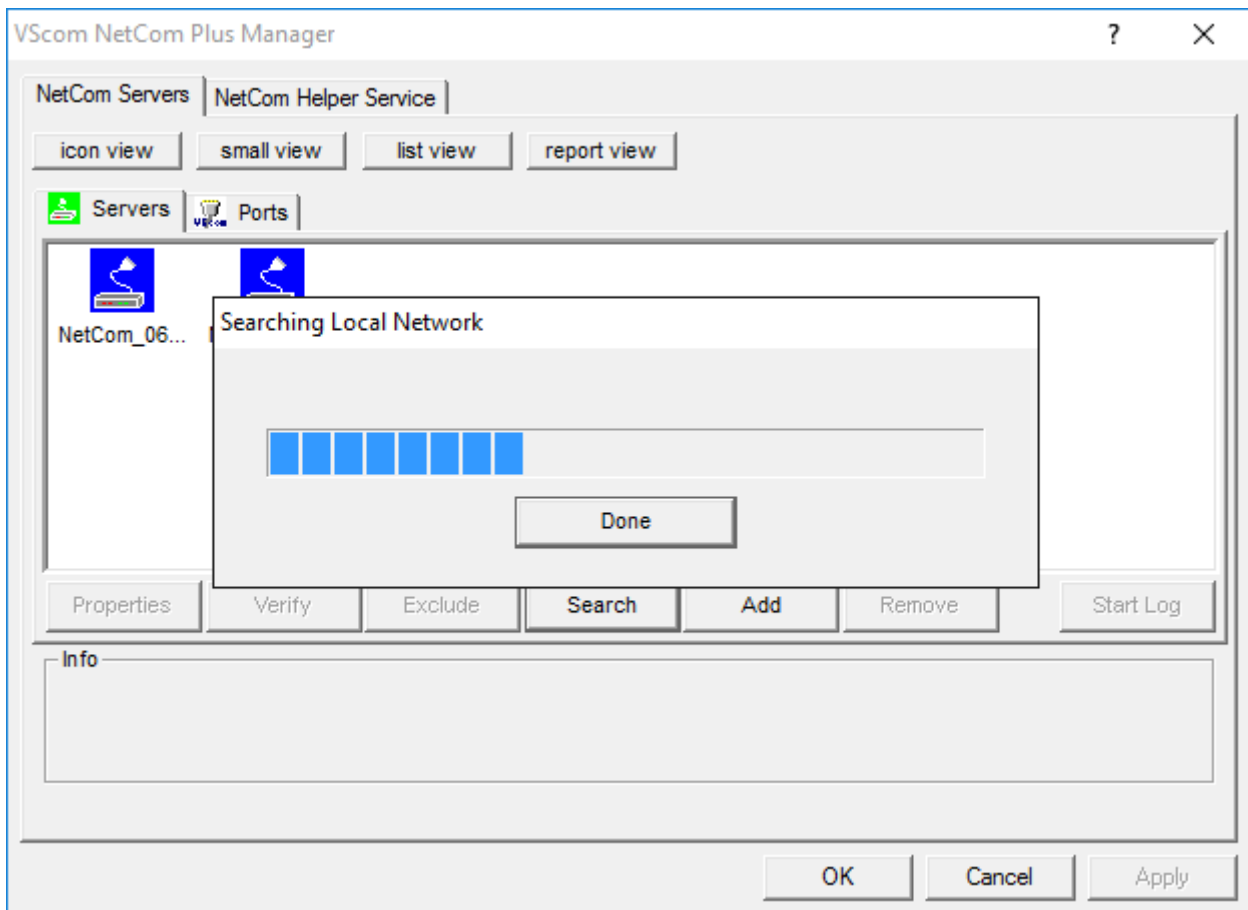
Figure 25: Discover and Select NetCom⁺ Devices for Installation

After short time the search process is finished. All the discovered NetCom⁺ are listed. In your very first installation of NetCom⁺ Devices and Drivers you should connect only one NetCom⁺ to your network. This single Device is listed here. Identify it by comparing the serial number shown in the NetCom Manager.

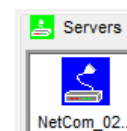
Figure 26: NetCom⁺ in Manager

4.1.2.1 Configure IP Parameters As mentioned above, it is important to configure the NetCom⁺ to operate in your network. In many networks this is done by a special server (DHCP). Please ask your Network Administrator for information. If you need to define parameters manually, double-click the devices icon.

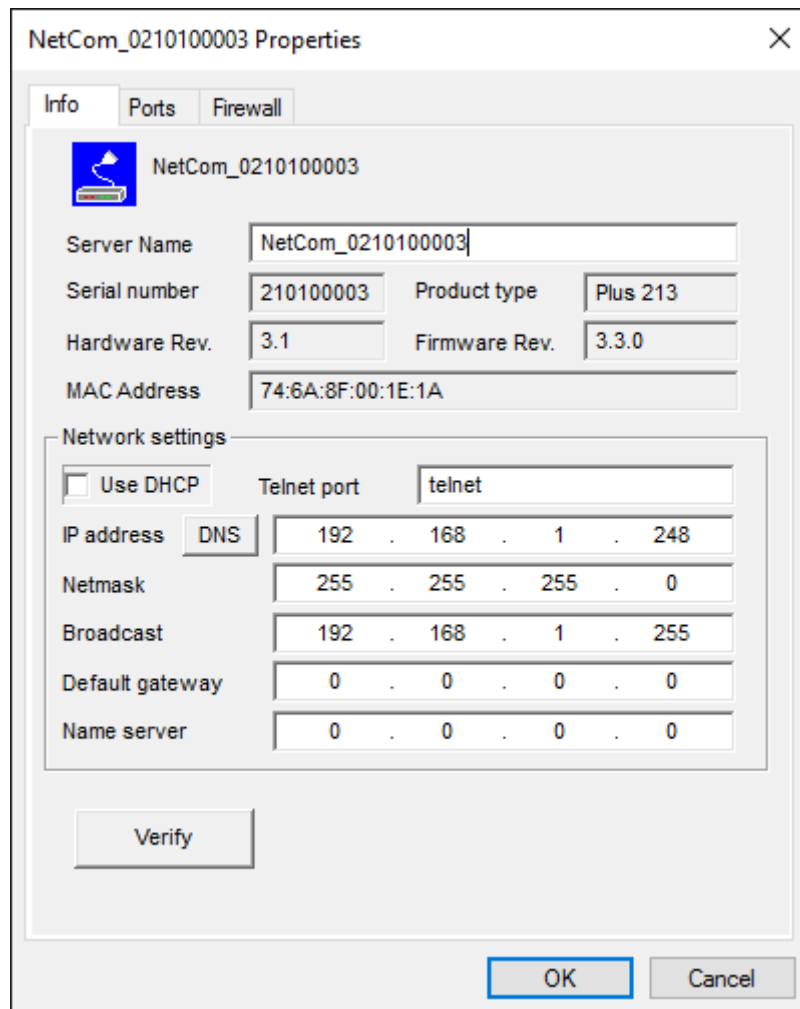
Figure 27: Define NetCom⁺s IP Configuration

This panel opens. Deselect the Option of **Use DHCP**, and place your parameters as **IP address**, **Netmask** and **Broadcast**. Click on the **OK** button. You may also enter a **DNS** name instead of the IP Address.

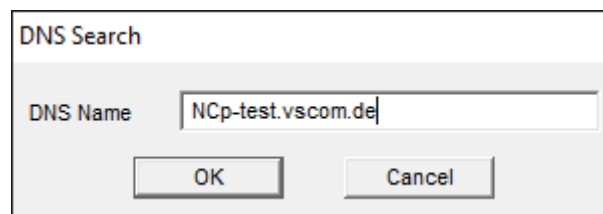
Figure 28: DNS Name for NetCom⁺ Server

Click the **DNS** button, and enter the Qualified Domain Name defining the NetCom⁺ Server. Your Administrator will provide you with it. This name is translated to an IP Address and used by the driver.

When all parameters of the configuration are set, click the **OK** button. This will update the configuration of the NetCom⁺, the new parameters are sent to the device.

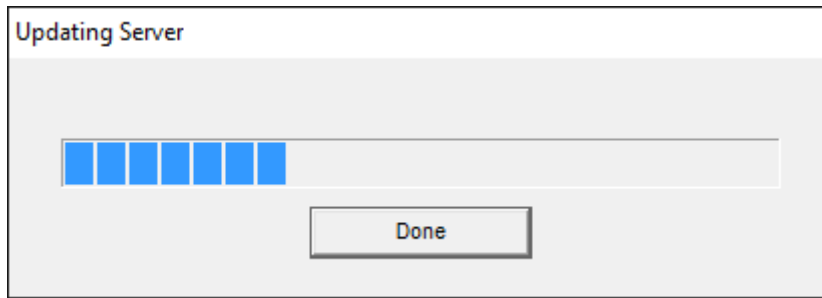

Figure 29: Sending Parameters to a NetCom⁺

4.1.2.2 Configure Firewall As you will notice in figure 27 the driver may also operate by traversal of a Network Firewall. This requires a special configuration, which is skipped here. Please read in detail in section 5.5 on page 57. For now proceed with the standard installation.

4.1.3 Install Drivers

You are now back in the NetCom Plus Manager. Click the **OK** button, the installation continues. Windows detects the serial ports on the fresh NetCom⁺ as new Hardware. All new Virtual Com Ports are installed without manual intervention by the user.

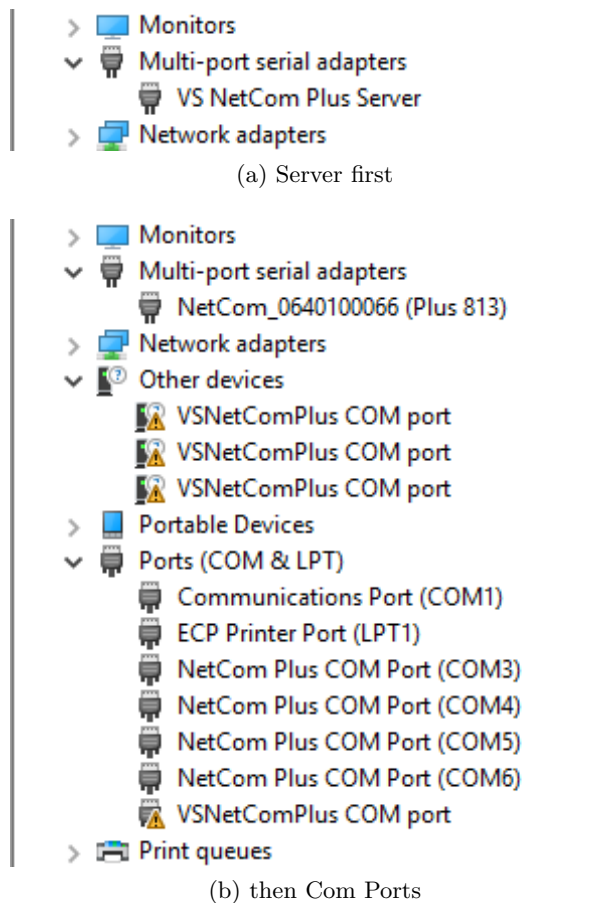
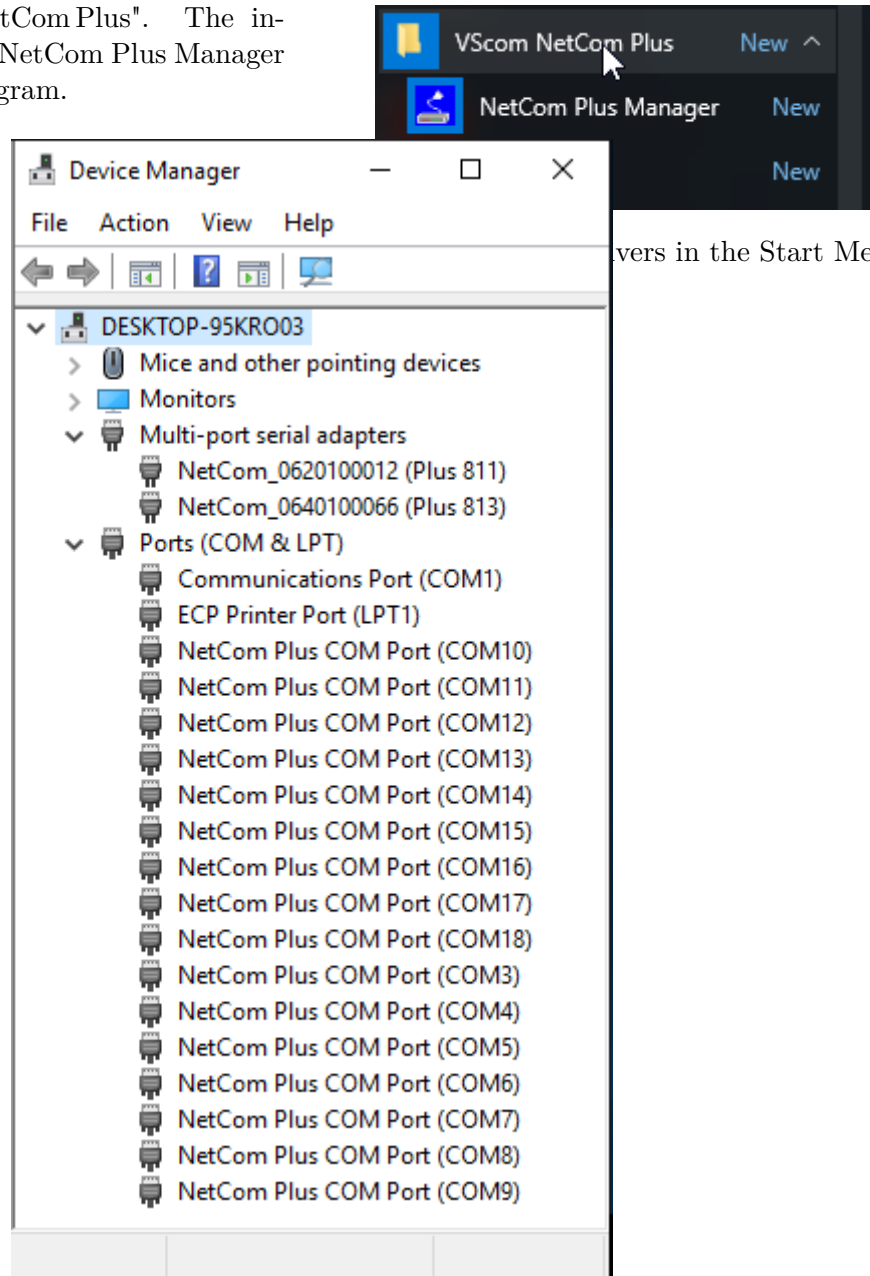

Figure 30: Virtual Com Ports installing in Windows 10

In Windows 10 everything happens in the Device Manager. You may notice the installation of the NetCom⁺, followed by the Virtual Com Ports appearing one after the other.

4.2 Verify the Installation

In the Start Menu you'll find the new program group "VScom NetCom Plus". The installed programs are the NetCom Plus Manager and a Driver Repair program.



...vers in the Start Menu

Figure 32: NetCom⁺ in Device Manager

In the Device Manager the serial ports are listed in the usual section **Ports**. Additionally there is the device class **Multi-port serial adapters**. All installed NetCom⁺ Devices are listed herein. The available options are described later.

4.3 Update the Drivers and Tools

As suggested by figure 47 the Installation Wizard offers an option to **Update** the drivers to a new version. Windows itself also offers an option to update the drivers of installed devices. Although this is a functional option, the correct operation of the NetCom⁺ drivers depends on a common version for all drivers. The secure way to perform such an update is to run the Installation Wizard. All driver files are replaced by later versions simultaneously, and all configuration data (Com number, special port configurations, ...) is preserved.

4.4 Configuration of the Virtual COM Driver

If properly configured, the serial ports of the NetCom⁺ Devices appear as Virtual Com Ports in your computer. The "virtual" means, in the computer is no real hardware related to the serial port, however the driver offers the full functionality of a serial port to the system. The interface used by the driver is VCOMM, which in turn is supported by the Windows API. So Windows does not see a difference to Com1, and also no application should detect the change.

When the serial ports are installed by the Virtual Com driver software, any application may use them. In the Device Manager they appear as **NetCom Plus COM Port** (figure 32). Without special tests a program does not see a difference between Com1 and the virtual Com7. For example the Hyper Terminal⁴ program has no problem to communicate through these Virtual Com Port. And this situation is common amongst most programs.

4.4.1 Configure the Serial Ports

A typical application selects a serial port, and opens it. After that it performs the standard configuration of bits per character, parity settings and number of stop bits. Also the flow control (handshaking) is defined by the application. Windows sends these requests to the port driver, and this driver sends the requests to the serial port on the NetCom⁺.

⁴or PuTTY Terminal Emulation

Figure 33: NetCom⁺ COM Port Serial Settings

The same parameters may be pre-configured in the Device Manager. This is done via the **Properties** of the **NetCom Plus COM Port**. In the **Local Settings** tab these standard parameters are defined. Since most programs configure these parameters by themselves, the values are very rarely used. A typical situation is a serial printer attached to this virtual port.

4.4.2 Performance Issues

Operation through the network causes some extra time, which is approximately 5 Milliseconds. For comparison, with a port internal to the computer this time may be just some 100 Microseconds. This added time has an impact on reaction times. Some data protocols may be sensible. A lot of configurations are possible to compensate for this. But these have an effect on the sheer data throughput of the virtual serial port.

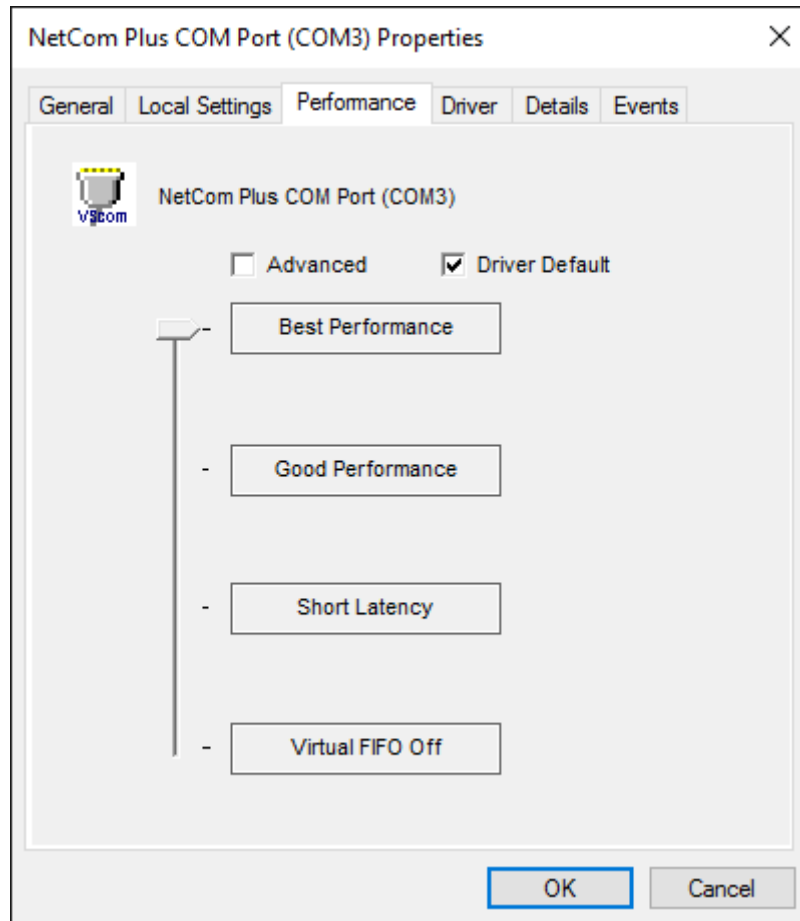

Figure 34: NetCom⁺ COM Port Performance Settings

Consequently the configuration starts on the **Performance** tab. There are four already defined sets of parameters.

Best Performance is the default configuration. The driver software and the NetCom⁺ communicate with big data blocks. As a result a reaction on short events on the serial port is somehow delayed. For applications operating with short data blocks, and waiting for short answers this is not optimal. It causes transmission delays, called Latency.

Good Performance uses smaller blocks. The Latency may be reduced a little bit, depending on the application. But the impact on the data throughput is small.

Short Latency mimics a 16C550 with full FIFO enabled, but no network timeouts will occur. This means the block size is 16, quite small for network operations.

Virtual FIFO Off simulates a deactivated FIFO, which is the fastest setting in terms of latency. The port is configured as if the FIFO is off, buffers are configured to never wait for a timeout, hence gaining in best reaction times. The FIFO buffers are not deactivated in reality, they are still used to prevent data loss.

Driver Defaults returns to the standard settings when enabled.

Advanced opens access to detailed configuration of the operation parameters.

4.4.3 Network & Misc Properties

When you use the **Advanced** checkbox on the **Performance** tab, the **Network/Misc** tab opens automatically.

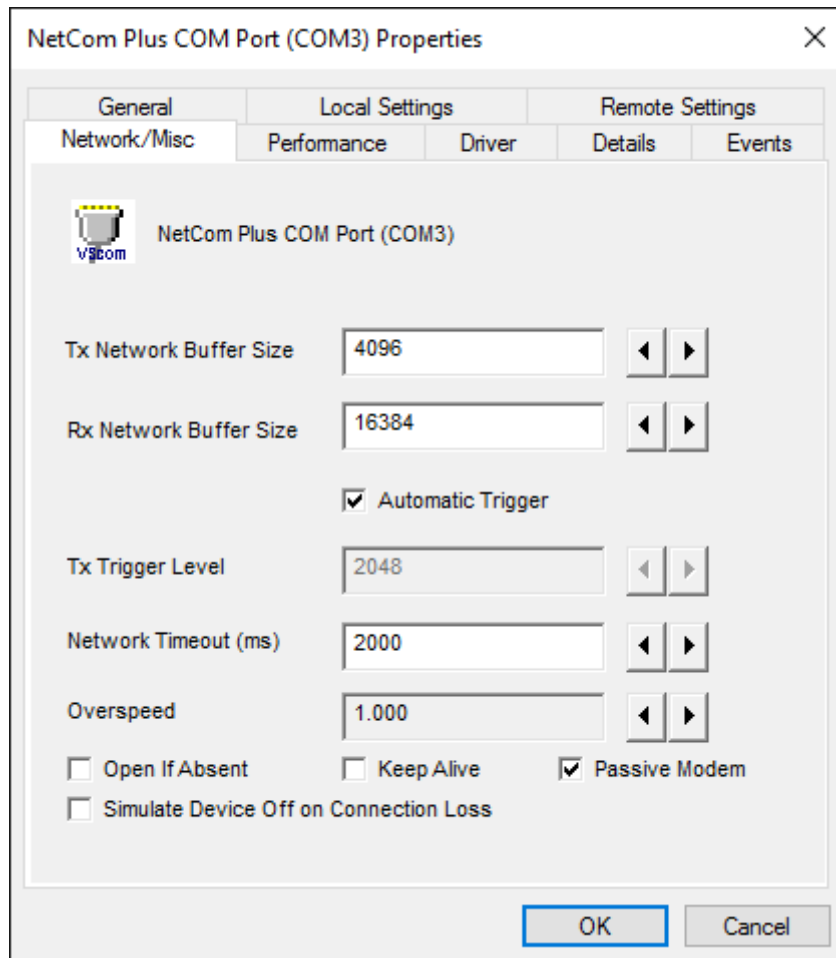

Figure 35: NetCom⁺ COM Port Network/Misc Properties

The parameters on this tab control the operation of the driver software on the computer.

Tx Network Buffer Size: If the application sends small chunks of data to the driver, these are buffered to send them in one large packet. This parameter defines the size of the buffer. And also the maximum packet size sent to the serial port by the driver software.

Rx Network Buffer Size: This is the size of the buffer to receive data from the NetCom⁺.

Automatic Trigger: based on internal rules, this checkbox selects a best practice value for **Tx Trigger Level**. Deactivate it to control that parameter manually.

Tx Trigger Level: Controls the time when data is sent to the NetCom⁺. If the Tx buffer holds at least this amount of data, the driver immediately sends them. If there is less data, the driver may use a timeout to determine when to send them.

Network Timeout (ms): This is the timeout.

Overspeed: This is a special option, not really related to network communication. There are old applications, limited in the maximum speed. With Overspeed you define a multiplier. The baudrate requested by the application is multiplied with this factor. The result is sent to the NetCom⁺ to configure the serial port. E.g. the application may be limited to 38,400 bps, but there is a modem capable of 230,400 bps on the serial port. Set Overspeed to a value of 6.000, and configure the application to use 38,400 bps.

Open If Absent: The NetCom⁺ may be used from a computer with a Dial-Up connection. When this option is used, the driver will delay the connection to NetCom⁺'s serial port. Even when an application opens the port and configures the parameters, no command is sent. The connection is established when data is sent to the NetCom⁺, or when status information is requested.

Keep Alive: This option will periodically send control information to the NetCom⁺ to check if the connection is still operational. As a second effect a Dial-Up connection will not automatically close.

Passive Modem: This option controls how often the driver retrieves Modem status information from the NetCom⁺. If activated, the driver never asks for the modem status. Instead the NetCom⁺ informs the driver of any changes. If an application frequently requests the Modem status, it gets the last value received. On slow networks like the Internet this option is recommended.

If inactive, the driver software retrieves the Modem status from the NetCom⁺ serial port each time the application requests it, but with a maximum frequency of 10 per second. If the latest retrieved information is not older than 100 milliseconds, this value is returned.

Simulate Device Off on Connection Loss: When this option is enabled, the NetCom⁺ driver does not attempt to preserve transmitted data. If on a normal serial port the connected device is switched off, all data sent to this device gets lost. NetCom⁺ simulates this behavior. All data sent from the application to the driver is discarded, when the TCP connection to the NetCom⁺ is lost. The NetCom⁺ driver attempts to re-establish the connection in regular intervals. When the NetCom⁺ is available again, data may be transferred from then on.

4.4.4 Remote Settings Properties

The other panel created by activating the **Advanced** checkbox on the **Performance** tab, is the **Remote Settings** tab.

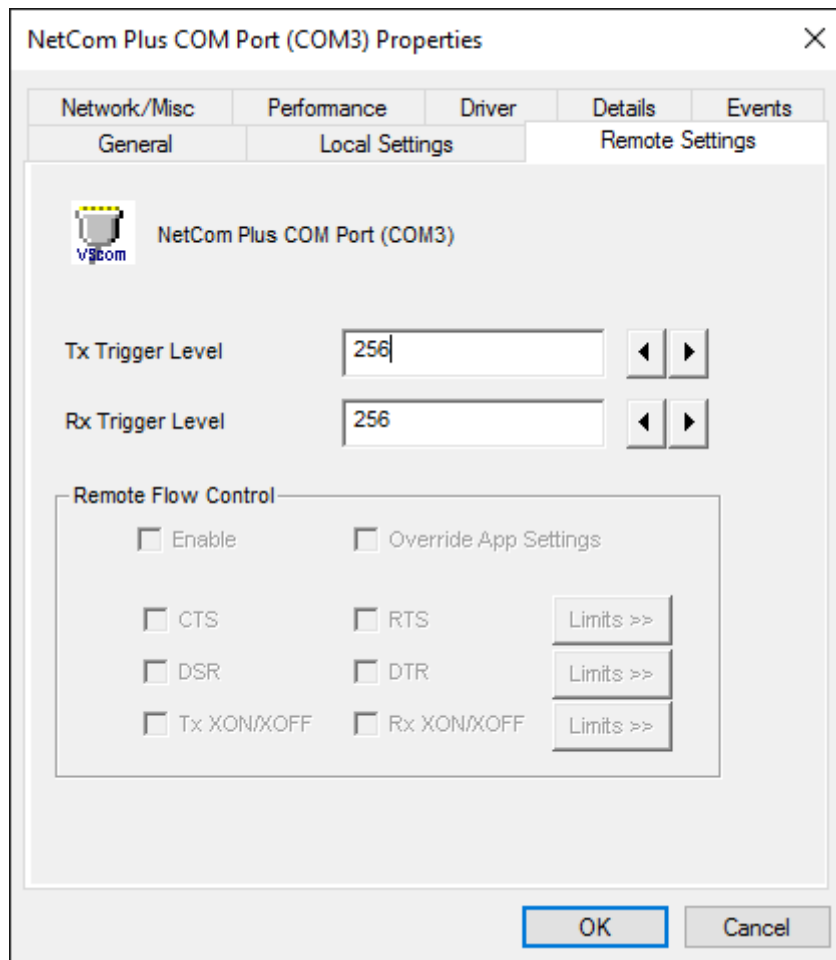

Figure 36: NetCom⁺ COM Port Remote Settings Properties

The parameters on this tab control the operation of the serial port on the NetCom⁺ Device. They are defined and activated by the driver software.

Tx Trigger Level: The serial port on the NetCom⁺ Device buffers data for transmission to external devices. If the amount of data in this buffer drops below this level, the NetCom⁺ is capable to receive new data. It will send a related event to the driver software.

Rx Trigger Level: When the serial port has received this amount of data, these are sent to the driver on the connected computer. If the amount is less than this, the NetCom⁺ applies a timeout of about 5 character times. This means the timeout varies with the serial transmission speed.

The **Remote Flow Control** panel signals the NetCom⁺ to perform the handshake on its own. This is necessary, because the network delay of some milliseconds is too long for reliable operation in many situations.

Enable: The configuration shown here is active, when the pre-defined performance levels are used. When using the 'Advanced' option, Remote Flow Control is completely disabled. Enable as required. While it is best practice to configure as figure 36, you can disable certain events here.

CTS, DSR, Tx XON/XOFF: these control the output of data to the serial port.

RTS, DTR, Rx XON/XOFF: used to stop transmission from the connected device.

An application has the option to use any combination of these methods at the same time. The command to use them is transferred to the NetCom⁺. For example, if the port is configured to use Hardware Flow Control, the NetCom⁺ will control the RTS line, and observe the CTS line. If requested, any of these methods may be unchecked. In that case the driver software on the computer will control the lines.

Override App Settings: In rare situations it is necessary to ignore the applications configuration. Check this box, and select the Flow Control functions to use with the device.

Limits: These buttons are prepared for future software versions.

4.4.5 Installation of NetCom Plus Servers

This section of the manual covers the correct installation of the drivers and serial ports. Please do a quick review of the section 4.1, before reading further. As of the time of writing, the current driver is version 2.0.3.0

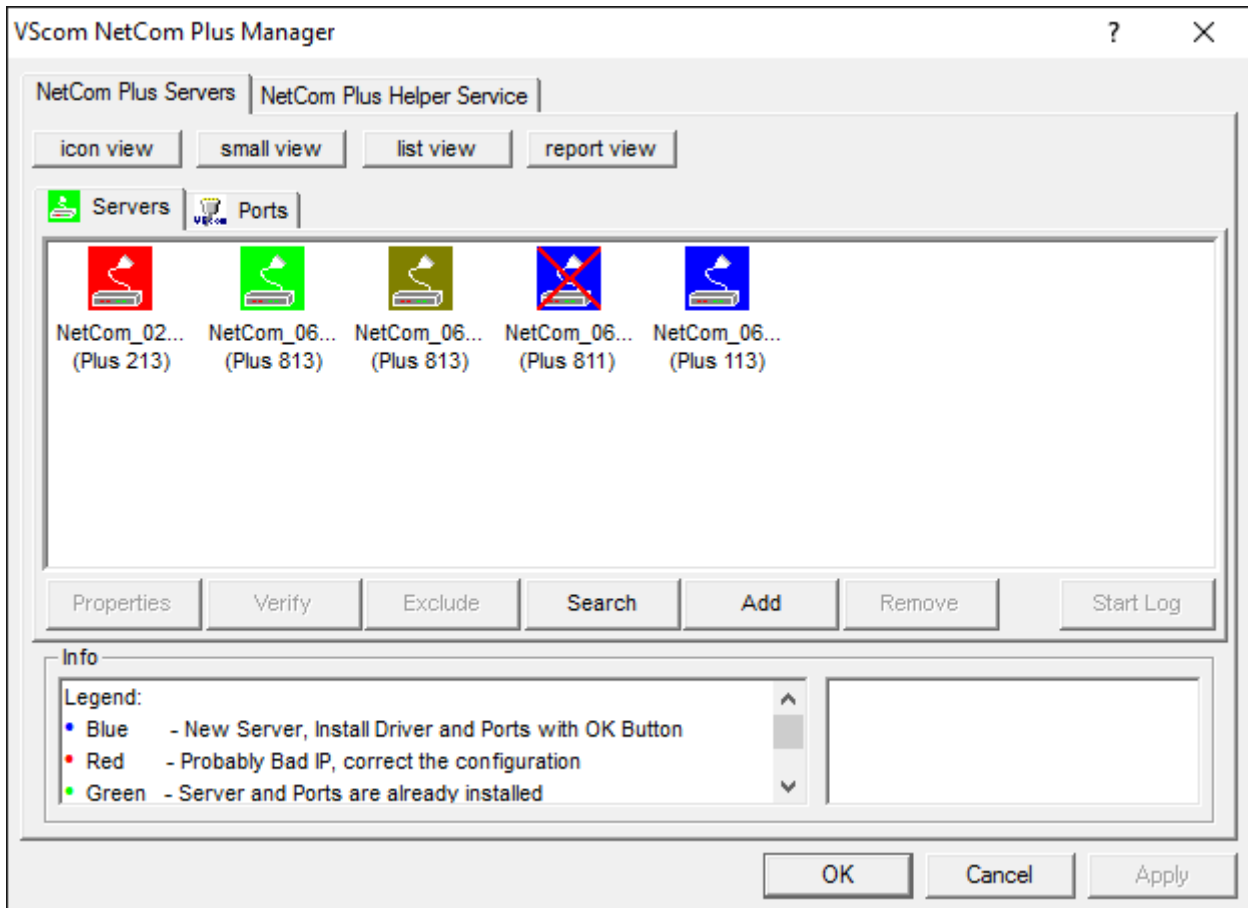

Figure 37: Select NetCom⁺ to install

The NetCom Plus Manager program is automatically started by the Installation Wizard, or later intentionally by the user (see fig. 31). There are different ways the NetCom⁺ servers are listed.

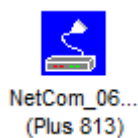

Figure 38: New NetCom⁺

The first time a NetCom⁺ is detected it is displayed in blue color. This indicates a “New” status, i.e. it is not yet installed in the system, but it is ready to. When the NetCom Plus Manager is closed by the **OK** button the server and the serial ports on it are installed in the operating system.

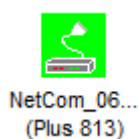

Figure 39: Installed NetCom⁺

When the NetCom Plus Manager is started a second time, usually the NetCom⁺ in the network are already installed in Windows. Then the icon is shown in green color. Exiting the NetCom Plus Manager by **OK** button will not change this part of the installation.

Figure 40: “Bad” NetCom⁺

An icon in red color indicates possible problems. To correctly operate the virtual Com Ports the driver must establish TCP connections from the PC to the NetCom⁺. This requires a matching configuration of IP parameters in the NetCom⁺ and in the PC. If the NetCom Plus Manager detects such a TCP connection is not possible with the current configuration, it displays this warning. Click the Icon, and the right section of “Info” will show some details to find the problem. If the NetCom Plus Manager is now closed by the **OK** button, the server and the serial ports on it are installed in the operating system but will not operate correct.

Figure 41: Excluded NetCom⁺

Often there are more than only one NetCom⁺ listed. And sometimes not all of them are to be used on this specific computer. The **Exclude** button is used for that purpose. Select a NetCom⁺ Device, and click on that button. The driver will later ignore this NetCom⁺, when installing and operating the serial ports. The Icon changes to olive color.

To later include such a NetCom⁺, just use the **Include** button to change the status. The **OK** button will then install the server and serial ports in the system.

Figure 42: Disconnected NetCom⁺

The NetCom Plus Manager holds a list of NetCom⁺ it has detected on previous occasions. On every start it attempts to detect these servers again. If for any reason this is not possible right now, the icon is shown with a red cross on it.

If a NetCom⁺ has not been operational when the Manager program was started, it is either displayed with the cross, or not displayed at all. You may make it operational by connecting it now. To install it, use the button **Search** to find it in the network. Or **Add** it manually with that button (section 5.5).

Similarly to the **Exclude** / **Include** of specific NetCom⁺ servers, you may do so with selected serial ports.

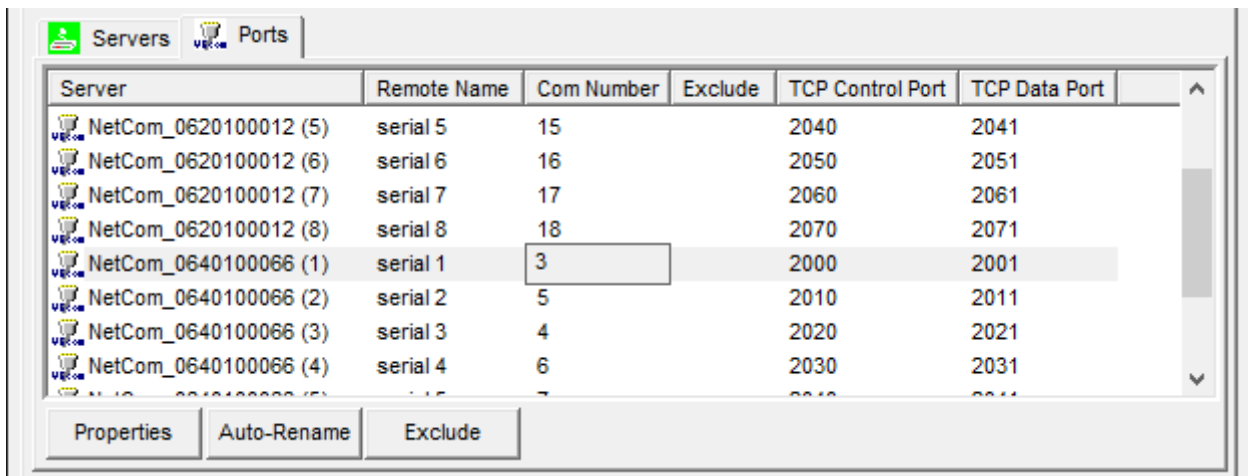

Figure 43: NetCom Plus Manager Ports View

Select the Ports section in the Manager. These are the special options used while installing the driver software. At any time after installation the configuration may be changed by the NetCom Plus Manager program. This may result in serial ports appearing in or vanishing from the system.

4.4.5.1 Changing the Installation There are common situations, when the current configuration needs a change. In the first case the NetCom⁺ has a new IP Address, i.e. this has been changed not using the Manager application. Reasons may be the NetCom⁺ has been moved to a different location, or the logical structure of the network has changed. Because of the changed address the driver does not find the serial port to contact.

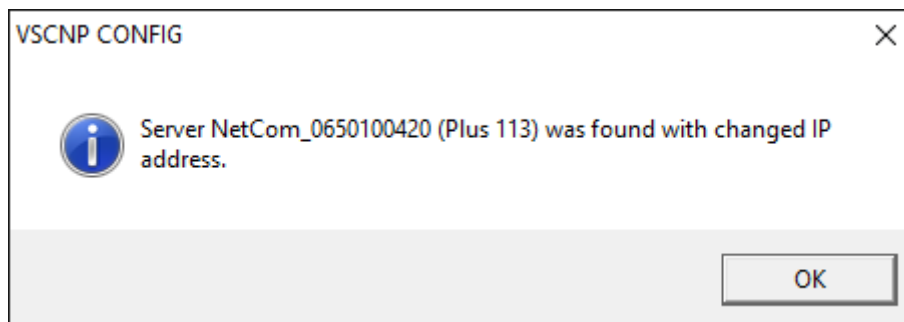
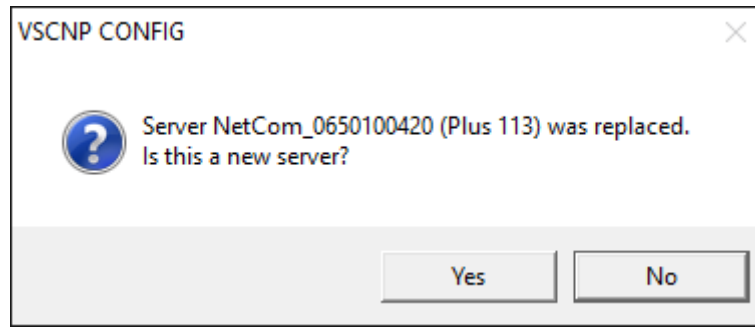

Figure 44: Reconfigured NetCom⁺ found

Now open the NetCom Manager. It will re-detect the devices. In this process the Manager finds the already installed NetCom⁺, but with a new configuration. Confirm this change by clicking **OK** here and subsequently in the Manager. The parameters of the installed Virtual Com Port are changed to contact the same serial ports on a new network address. In the Device Manager of Windows it may be necessary to search for hardware changes, and then the new parameters are displayed there.

Figure 45: Replaced NetCom⁺ found

The second case occurs, when a NetCom⁺ is replaced by another device. This new device shall have the same configuration, especially the same IP Address. When you start the NetCom Manager, it will detect a new device with parameters already in the database. It is assumed the new device shall replace the old one, click on the **No** button to confirm. Otherwise an installation of new serial ports is performed.

In general the driver software and the NetCom Manager identify the NetCom⁺ Devices by the combination of IP Address and serial number (plus MAC Address). If one of these is changed, the above requests appear.

4.5 Uninstall the Drivers and Tools

To completely uninstall the NetCom⁺ Drivers and files, there are two basic methods. The usual way is to use the program uninstall option of Windows operating system. On Windows 10 open Settings and therein the SYSTEM function. Select Apps & Features, and scroll down to the VScom drivers. Select this entry and click the **Uninstall** option. This will start the NetCom⁺ uninstallation program.

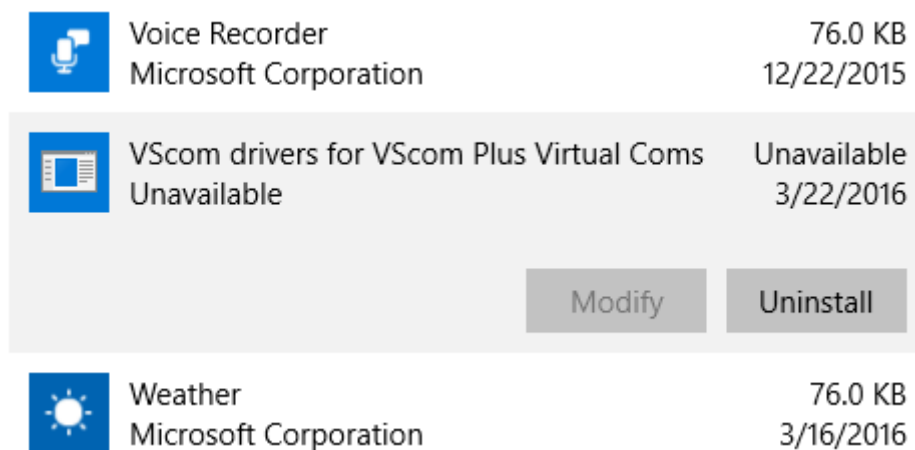
Figure 46: Uninstall NetCom⁺ Drivers via Settings App

The other basic method is to start the Installation Wizard again from CD-ROM or the installation directory.

The Wizard will detect the drivers on the system. You have the options to **Repair** the current installation, or to **Remove** the installed drivers. Since the Installation Wizard is of the same version as the installed drivers, the option of **Update** is not available.

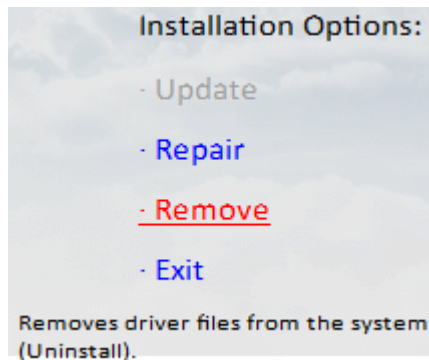

Figure 47: Remove, Repair

A **Repair** replaces the driver files on the system with those in the installation package. Since this is the same versions, the files should also be the same. If anything is damaged in the installed drivers, the Repair process will correct the problems.

As expected the **Remove** process will uninstall drivers and tools from the system. The drivers are removed from the configuration and also completely deleted from the System drive. This happens with any configuration data also. Afterward the system is available for a clean installation.

5 Configure with NetCom Plus Manager

Shipped with the NetCom⁺ Devices there is a versatile program for Windows Operating System, named NetCom Plus Manager. This program shall detect, manage and configure the NetCom⁺ Devices in your network. You can start it by several ways. First of all it is part of the driver installation available for download. You may unpack the Complete Installer and get direct access to the files. The Manager is named NETCOMMGR64PLUS.EXE⁵.

When the Virtual Com Drivers are installed, there are more options to run the program. Since some operations with NetCom Plus Manager require administrators privileges, the User Account Control kicks in.

Also the process of installing the drivers created a new program group in the Start Menu.

This section of documentation focuses on management of the NetCom⁺ Devices. The options to configure driver-specific parameters of the serial ports are skipped here. This includes some buttons and panels. They are described in total in section 4.4, in the documentation of the drivers and panels.



Figure 48: NetCom Plus Manager

⁵NETCOMMGRPLUS.EXE in x86 Editions of Windows

While in the configuration process, a click on a button or a double-click on an item opens properties or other options. In many situations, a right-click with the mouse opens context-sensitive options. Just try it out. The NetCom Manager is designed to help configure driver options. So for very detailed configuration of a NetCom⁺, it is better to use the Web browser interface, or do it via Telnet as described in section 6. Here are the options.

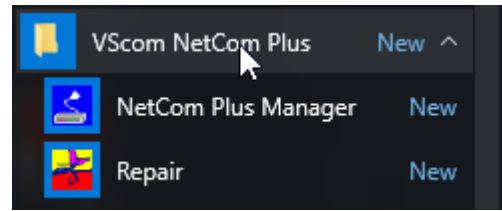

Figure 49: NetCom Manager in Start Menu

5.1 Starting NetCom Manager

When NetCom Manager is started, it will ‘Search’ the NetCom⁺ in your LAN by SNMP. This process may take up to 30 seconds. The devices in a LAN are typically found in the first seconds. If this is enough for you, you can stop the search by click on the ‘Done’ button.

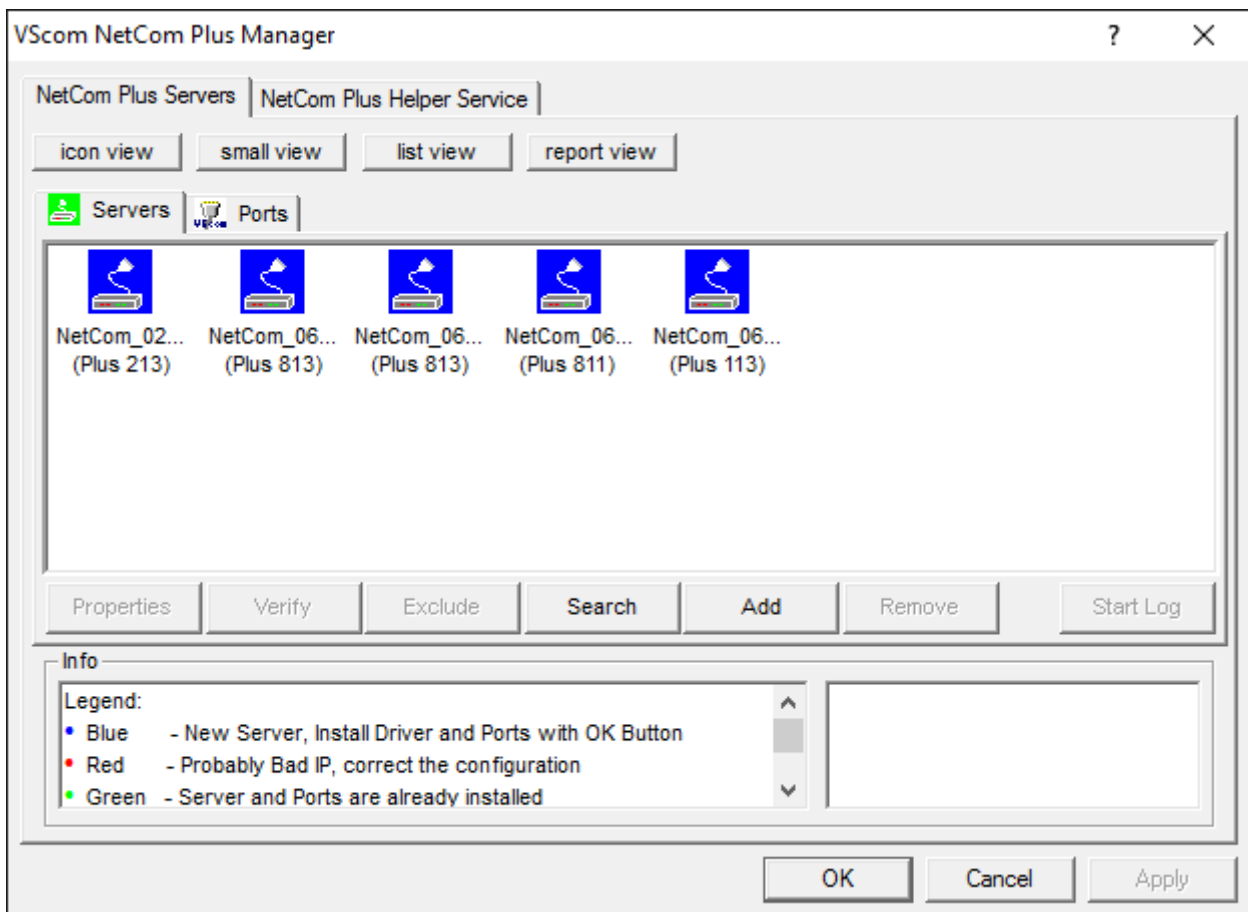

Figure 50: NetCom Manager Servers Panel

The NetCom⁺ are listed here in the **Servers** panel. Since the **Search** uses broadcast mechanisms, the range is limited. If you have Routers in your network, or you contact some NetCom⁺ via Internet, you must **Add** them manually (section 5.5). Enter the network parameters to access the NetCom⁺.

Select a NetCom⁺, and click on the **Properties** button, double-click the Icon, or use a right click. Using **Verify** the NetCom Manager contacts the NetCom⁺ to check if it is properly configured and online. **Exclude** is only useful in conjunction with the Virtual Com Drivers, so skipped here. **Search** repeats the search from the program start, and may be used at any time. **Remove** removes a NetCom⁺ server from this list. This option is most often used to clear old data from the drivers database. For monitoring purposes you may select a NetCom⁺, and **Start Log** for this. It may be done for several Devices at the same time. The output is visible in the **Log Windows** panel.

5.2 NetCom Server Settings – Info

As described above, open the **Properties** of a NetCom⁺ Device. The Server Settings start with the **Info** panel. Configure the options as your network requires.

The screenshot shows the 'NetCom_0210100003 Properties' dialog box with the 'Info' tab selected. The fields are as follows:

| | | | |
|---------------|-------------------|---------------|----------|
| Server Name | NetCom_0210100003 | | |
| Serial number | 210100003 | Product type | Plus 213 |
| Hardware Rev. | 3.1 | Firmware Rev. | 3.3.0 |
| MAC Address | 74:6A:8F:00:1E:1A | | |

Network settings:

Use DHCP Telnet port: telnet

| | | | | | | | |
|-----------------|-----|---|-----|---|-----|---|-----|
| IP address | 192 | . | 168 | . | 1 | . | 248 |
| Netmask | 255 | . | 255 | . | 255 | . | 0 |
| Broadcast | 192 | . | 168 | . | 1 | . | 255 |
| Default gateway | 0 | . | 0 | . | 0 | . | 0 |
| Name server | 0 | . | 0 | . | 0 | . | 0 |

Buttons: Verify, OK, Cancel

Figure 51: NetCom Manager Server Settings - Info

The **Server Name** is just for information. As factory setting it includes the serial number of the device. You may change it to any string (of ASCII characters), since there is no functionality related to the name. This name is listed in the Server panel of NetCom Manager. The next parameters are fixed, and displayed for information only.

The **Telnet port** allows to configure this NetCom⁺ via Telnet. The value is a TCP port number. Factory setting is 23, the standard port for Telnet protocol. By default the NetCom⁺ is set to **Use DHCP** for automatic configuration of IP parameters. This is the suggested method. However there are several situations where this option can not be used. In this case deactivate it. When inactive, other parameters may be changed. The basic parameters **IP address** and **Netmask** are mandatory. Instead of an IP Address you may enter a **DNS** name. The NetCom Manager will resolve that name to the actual IP Address.

If address or netmask are changed, the NetCom Manager calculates a matching address for **Broadcast**. You may also change this address. The DHCP option will also configure the **Default gateway** and the **Name server**. Without DHCP you must enter these parameters by yourself, enter 0.0.0.0 if they are not used.

5.3 NetCom Server Settings – Ports

The **Ports** panel lists all serial ports of a NetCom⁺. Some of the options are driver related, e.g. the **Com Number**. Each serial port may operate via two TCP ports.

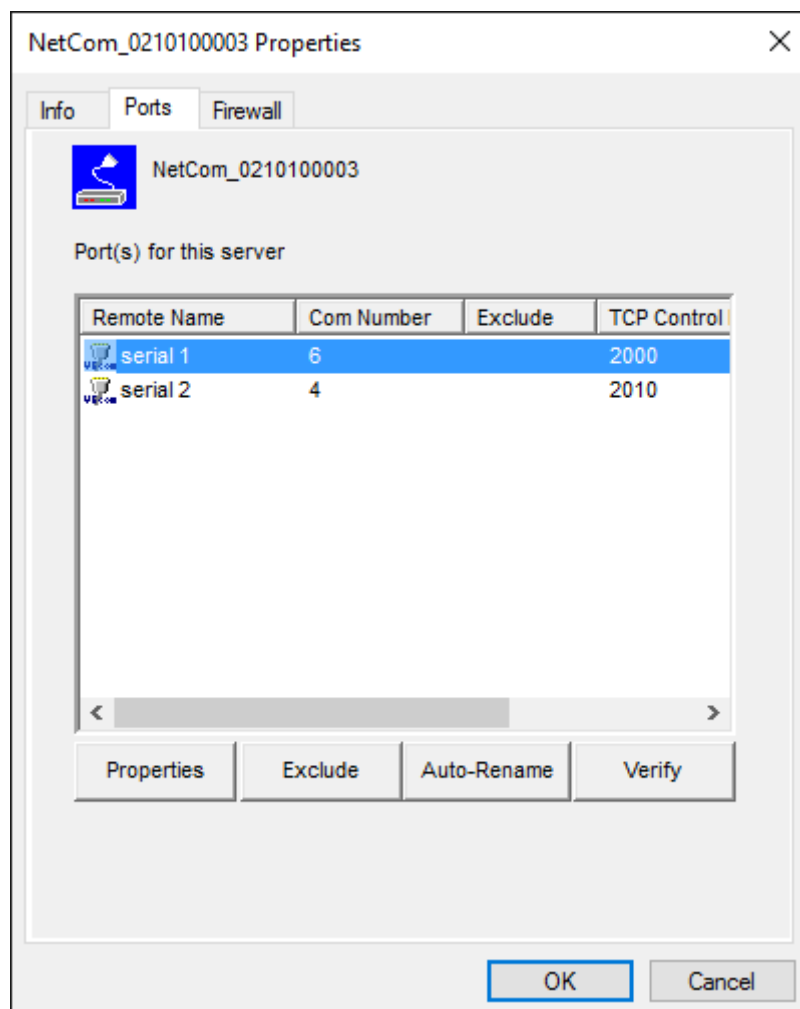

Figure 52: NetCom Manager Server Settings - Ports

The **TCP Control Port** is used in the Virtual Com Driver mode, and also in Null-Modem Tunnel. If Driver mode is not desired, this parameter is ignored almost always.

The **TCP Data Port** is used to transmit data to and from the serial port. Use the default, or change the value to the settings required for your network.

There is also a **UDP Data Port**, used in packet data transfer. You can not switch the NetCom⁺ to UDP mode with the Manager. But if it is already in this mode, you can change this basic parameter.

5.4 NetCom Server Settings – Firewall

Many networks use a Firewall to protect the stations in the network from other networks, including the Internet. In some situations the contact to a NetCom⁺ must pass through such a Firewall configured for NAT (Network Address Translation, section 16).

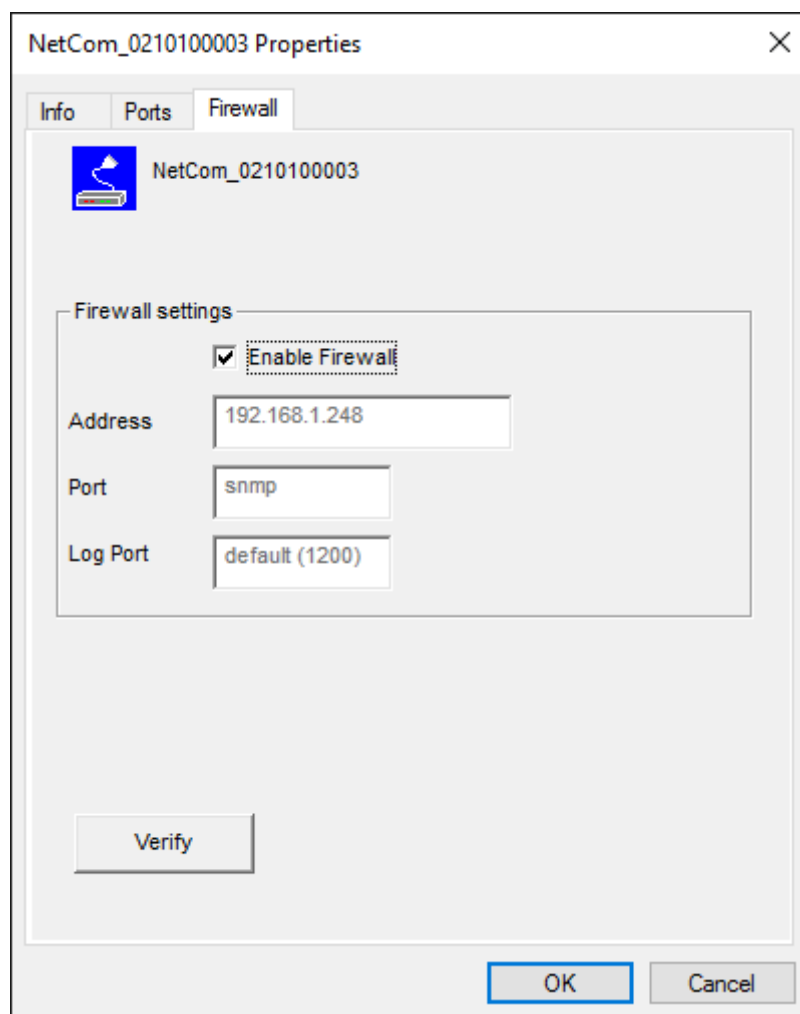

Figure 53: NetCom Manager Server Settings - Firewall

To do this you must **Enable Firewall**, and enter the **Address** of the Firewall. The address may be the IP Address, or the Qualified Domain Name (DNS).

The Manager configures a NetCom⁺ via SNMP, which uses UDP. The Firewall must have a special **Port** to receive those data, and to transfer it to the internal network. Enter this port here.

The same scheme applies to the logging option. When logging is active a NetCom⁺ listens on port 1200 for logging connections. The Firewall must also have a special **LogPort** to receive this connection, and to transfer it to the NetCom⁺.

The NetCom⁺ does not need any configuration to operate in a Firewall protected environment. This configuration here is for installation of the drivers. There is a Firewall tutorial section later in this manual (5.6).

5.5 Manual Detection/Installation of a NetCom

Sometimes the NetCom⁺ Device Server can not be detected by the automatic in the NetCom Manager. To detect and configure devices the protocol SNMP is used. The detection is done by sending out a broadcast on all available network interfaces of your computer. This SNMP broadcast is realized as an Ethernet broadcast. Such a broadcast is only transmitted through Hubs and Switches. When there is a Router between the computer and the NetCom⁺, probably the broadcast is not transmitted further. This is especially the situation when the NetCom⁺ is located somewhere via Internet, but also in big networks of some companies. If this is the case, the detection has to be done manually. Refer to figure 37 and **Add** the NetCom⁺ by use of the button. Enter the IP Address of the NetCom⁺ in the NetCom Manager Server Settings, and click the button **Verify**. Since now the IP Address of the NetCom⁺ is known, the NetCom Manager sends a request directly to this target, instead of a broadcast. This directed SNMP request is transported, even by Routers. The NetCom⁺ sends the normal reply, giving all required information to the NetCom Manager. Now it is possible to configure all options as usual. Also the drivers for virtual serial ports are installable now.

Please note, the drivers require to have the IP Address. They can not operate using a DNS name, because the driver can not perform a DNS name resolution. If your NetCom⁺ is located on a dynamic IP Address (e.g. on a Dial-Up connection with 24 hours disconnection), you need to reconfigure the driver installation, when the IP Address has changed.

5.6 Firewall Traversal Configuration

There are more difficult situations with a Firewall between the NetCom⁺ and the NetCom Manager. Many Firewalls protect the internal LAN by using the feature of NAT (Network Address Translation, 16). In this situation the IP Address of the internal device is not visible on the Internet. Only the Firewall can be contacted via its public IP Address. The NetCom Manager and the driver software for the virtual serial ports can handle such setups. But this requires certain configurations.

An easy-to-use alternative is the VPN function, which makes Firewall configuration quite easy.

5.6.1 SOHO Firewall example

The most easy situation for such a setup is by using a very simple SOHO Router as the Firewall. This configuration will show the principle of the technical details. Those principles can be transferred very easy to the configuration of more complicated installations.

On the SOHO Router there is only one public IP Address on the external side, and typically 254 internal private IP Addresses for the LAN side. These internal addresses may be assigned by DHCP or static. Such Routers offer a feature typically named "DMZ", which in fact is only a single exposed host. It is recommended not to use the "DMZ" for several reasons, some of them are security related. Especially it is recommended not to configure a NetCom⁺ as the DMZ host.

5.6.2 SOHO Virtual Servers

The Router also offers "Virtual Servers" (here named ViServ for short), which is the option required for NetCom⁺ installation. These ViServ operate by a technique called PAT (Port Address Translation, 16). Certain data addressed to the public IP Address of the Router are forwarded to the internal private address of the NetCom⁺. This way the NetCom⁺ can be contacted via the public IP Address of the Router.

First you need to configure the Router for some ViServs. As the absolute minimum there is one ViServ for the NetCom⁺ device itself, and another two ViServs for each serial port of the NetCom⁺. Those ViServs are to be configured for TCP or UDP transmissions. Please read in the manual of your Router how to do that. You need a port for the external interface, and an IP Address plus a port for the LAN side. The LAN IP Address is of course that of the NetCom⁺. As an example the most easy device is a NetCom⁺ 113 PRO. The internal port for SNMP is 161 for UDP. The serial port requires ports 2000 and 2001 for TCP.

| Function | External port | Internal port |
|----------|---------------|---------------|
| SNMP | 8161/UDP | 161/UDP |
| Control | 9000/TCP | 2000/TCP |
| Data | 9001/TCP | 2001/TCP |

Table 21: SOHO Firewall Pass-Through

Configure your Router for these example ViServs, and use the internal IP Address of the NetCom⁺ for the targets. Connect the NetCom⁺ to your LAN. Now you are ready for a very first test. Use Telnet to connect to the Data port of the NetCom⁺ serial port. Open a console (DOS Box) and type the command

```
Telnet <Routers-IP-Address> 9001
```

You will be connected to the serial port. Every character you type is sent out of the serial port, and every received data is shown on your screen. The serial parameters are pre-configured in your NetCom⁺.

5.6.3 NetCom Detection through SOHO Firewall

Now open the NetCom Manager as in section 5.5 above, and click the **Add** button. You again get the NetCom Manager Server Settings dialog. But now you have to select the panel named **Firewall** (see figure 53).

Check the Option **Enable Firewall**, and enter the IP Address of the Router in the **Address** field. In the field **Port** enter the target port for the SNMP configuration. From the Virtual Server example above this is port 8161. Since there is no configured ViServ for Logging, ignore this field. Click

the button **Verify** to have the NetCom Manager contact the Router. This is a directed request, so there is no problem with broadcasts. The Router will transfer the request to UDP-Port 161 on the NetCom⁺, which is the port for SNMP. The NetCom⁺ will answer the request, and send it out to your computer. The NAT function in the Router will replace the source IP of the data by its own public value, so the NetCom Manager will see the answer come from the Router. The NetCom Manager is satisfied with this data.

Some ISP will block the SNMP protocol, which typically means they do not transport data for 161/udp to their customers (this is the first reason why port 8161 was used in the example).

This answer brings every required information about the NetCom⁺, including its *internal* IP Address. Select the panel of NetCom Manager Server Settings to verify the information, but do not make any changes here. Changing the configuration may disconnect the NetCom⁺ from the protected LAN.

5.6.4 Serial Ports through SOHO Firewall

Now the NetCom⁺ is available in the NetCom Manager, but still the serial ports are not usable. The information of the TCP-ports for the ViServ related to the serial port is still missing. In the NetCom Manager Server Settings select the NetCom Manager **Ports** Panel. In this panel select one serial port, in this example of NetCom Plus 111 there is only one serial port. Click the **Properties** button to open the configuration of the port.

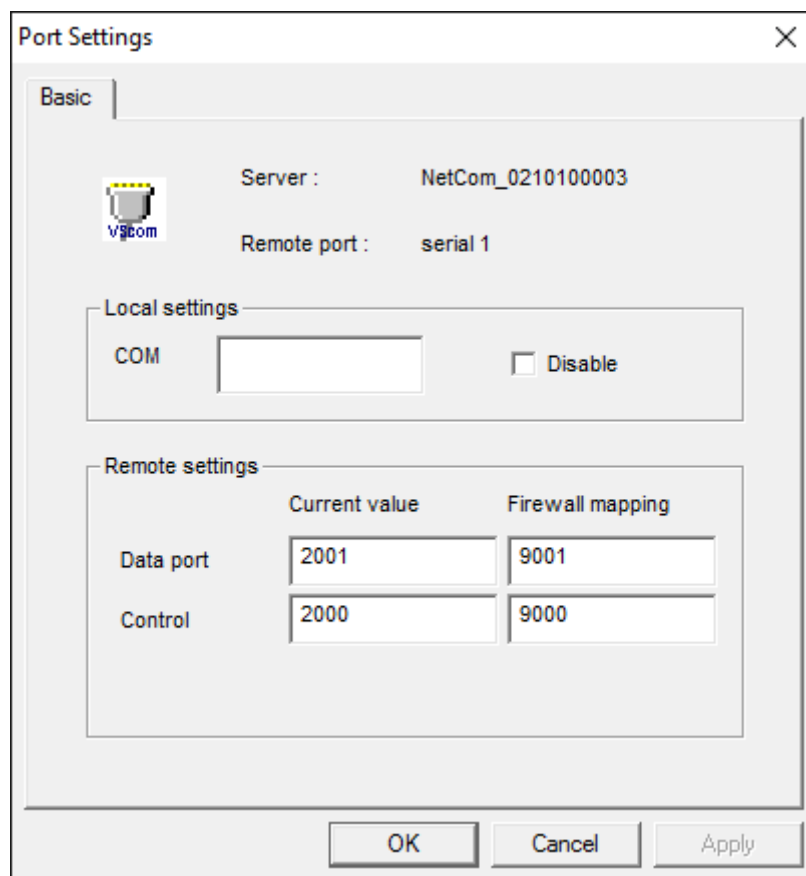

Figure 54: NetCom Manager Port Configuration for Driver

Since the Firewall function is enabled, the parameters for **Firewall mapping** are available for editing. Enter the ports defined in the Router, 9001 and 9000 in this example. Please note, so far there is no number for the Virtual Com Port available. The driver is not installed in this moment, and Windows does not know about the available hardware. This will happen later in the installation. Click the **OK** button, and proceed with the driver installation as already described.

5.6.5 DMZ and Virtual Servers

Why is it recommended not to use the DMZ function of the Router? There are two reasons. The first one is simple, only one device in the LAN can be defined as the DMZ target. The DMZ is implemented as "Send all IP data targeted for the Router to the DMZ station, unless there is a specific rule for a different target". When a second NetCom⁺ shall be installed on the LAN, the Virtual Servers have to be configured anyway.

The second reason is the security. Using the "DMZ" option the Firewall in the Router becomes transparent. All data from outside is transferred to the LAN, including all malicious data. In general this is not an especially smart idea.

5.6.6 Firewalls in Foreign Networks

There are many situations where it is not possible to configure the firewall between the Internet and the network where NetCom⁺ is installed. For example this may be a company network, where it is not allowed to open the firewall for external access to internal stations. Or it may be part of a GSM network, where the provider uses private IP Addresses to connect customers equipment.

Given such a configuration the NetCom⁺ has access to the Internet by establishing the connections on its own. This restricts the operation modes of the serial ports (see [6.2.2.2 on page 82](#)) to "TCP Raw Client" and "IP Modem", where the NetCom⁺ operates as a client. Here the NetCom⁺ establishes a connection to an external server, which is out-going from the network of installation. The user has to provide the external server, accessible via the Internet.

Another way to work around the restrictions is the encrypted VPN (chapter [10 on page 119](#)). Also here the user provides a server to manage the OpenVPN connections, and the users PC connects to this server. Once this is established there is the independent and not filtered network of the VPN, where all operation modes of the NetCom⁺ are available without limitations.

5.7 Dynamic IP Address and OpenVPN™

The option of Encryption uses a Virtual Private Network (VPN) based on a single TCP connection between the NetCom⁺ and a client computer. Regardless of strong encryption or even no encryption at all, here the key point is the single TCP connection. It is more simple to provide a Firewall configuration for a single connection, so the Router Firewall is more easy to set up.

The network link established by OpenVPN™ requires to have a target address and a port number. Since the basic TCP connection is activated by the `openvpn.exe` program, there is the freedom of using a DNS name for the target device.

With a Dynamic IP Address for the NetCom⁺ site, one of the several Internet services for Dynamic DNS (DynDNS) may help. It is even relatively simple to construct an own version. Using this service the `openvpn.exe` program gets the IP Address of the Firewall Router, and will establish the link. When the IP Address changes (after 24 hours), the connection first gets lost. OpenVPN™ will continuously attempt to connect again. When the new IP Address is known via DynDNS, the network link is re-established. The NetCom⁺ is available again, because the IP Address on the OpenVPN™ link did *not* change. Even when a serial port has been open, the function may continue seamlessly.

6 Configure the Operation Modes

The NetCom⁺ Devices are often used without the installation of a driver software. Customer applications contact the NetCom⁺ directly, using network functions. These setups require independent configuration of the NetCom⁺ Device and the serial ports. There are four ways to do this configuration. The NetCom⁺ offers a Web browser interface, configuration via serial port, via Telnet and also via SNMP. This SNMP option is not covered in this manual, please see separate documentation. The NetCom Plus Manager program for Windows is already explained above.

The access to the NetCom⁺ via web interface or Telnet is done via a TCP/IP connection between the computer and the NetCom⁺. So users need the IP Address of the NetCom⁺. Since firmware version 3.4.1 the most easy way to retrieve this information is UPnP. The NetCom⁺ regularly sends a special message, which your PC decodes. In Windows the detected NetCom⁺ are shown in Explorer section Network.

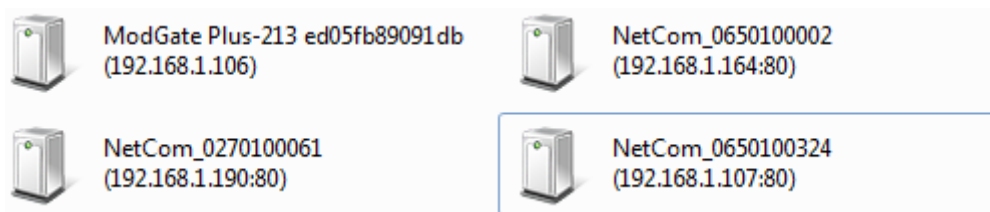

Figure 55: NetCom⁺ as UPnP devices

The IP Address is shown with each device, to use in Telnet for example. A double-click on an item will start your default web browser, and open the web interface of the NetCom⁺ Server.

The other easy way to retrieve the IP Address is the NetCom Plus Manager program (section 5). Start it, and open the Info Panel (figure 51) of the NetCom⁺ Server you want to configure. This panel displays the current IP Address of the NetCom⁺. Do not change the parameters, just write down the value.

The default configuration of a NetCom⁺ is to use a DHCP server. When such is not available, the IP Address defaults to that used the last time; with 192.168.254.254 as the factory value. When the IP Address of the NetCom⁺ is not in final state, leave the NetCom Plus Manager open while doing the first configuration of the NetCom⁺ Server. But in general the software may be closed as soon as the IP Address is known.

6.1 Accessing the Configurations

Here the manual shortly explains the different methods to get access on the parameters of a NetCom⁺. These parameters are the same, independent from the method for configuration. So the options are described later.

The configuration is accessible via web browser, a Telnet software with VT100/VT52 emulation, or via a Terminal emulation connected to the first serial port of the NetCom⁺.

6.1.1 Web Browser Configuration

Open your favorite web browser, and enter the IP Address as the target location. To avoid any confusion you should precede it with `http://`, so your browser has definite target information. Most browser programs do not need that. Your browser must not suppress images.

If the NetCom⁺ is password protected, you must enter this now. Leave the user name empty, just type the password.

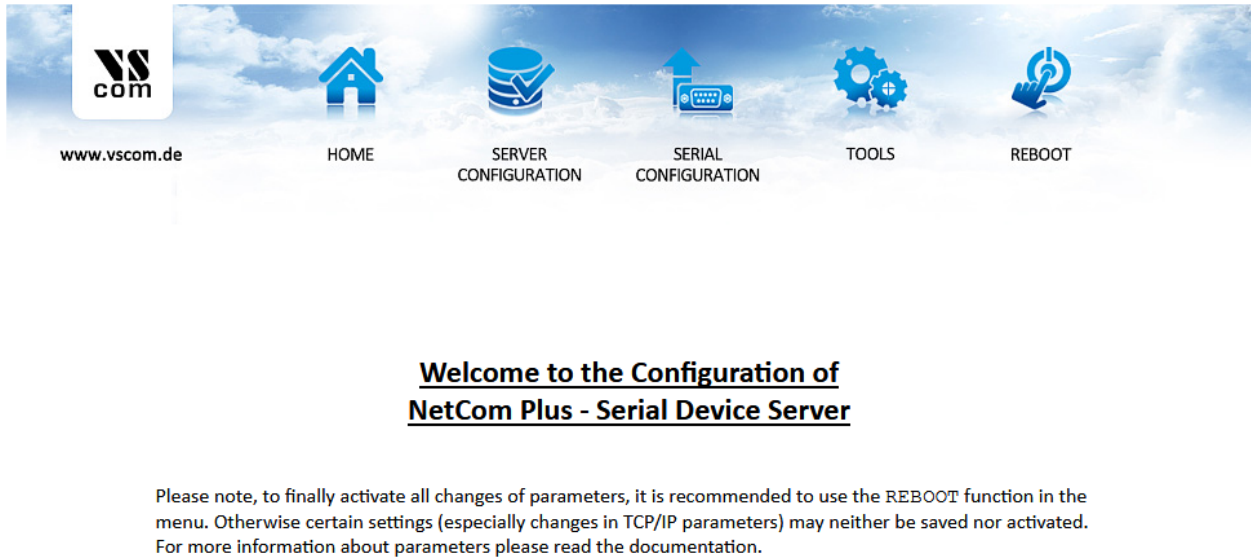

Figure 56: Configuration Menu in Web Browser

The NetCom⁺ welcomes you with its "Home" screen. To access the different options of configuration, the images above function as a link. In many menus you'll see a blue question mark. This is a symbol for help. When clicked a short explanation pops up, informing about the function of this parameter. Some other settings require a reboot to save and activate them. Whenever this situation occurs, the NetCom⁺ requests a REBOOT. The inset at the top left represents a link to the VScom web pages, where you get information about similar products and possible downloads like firmware and documentation.

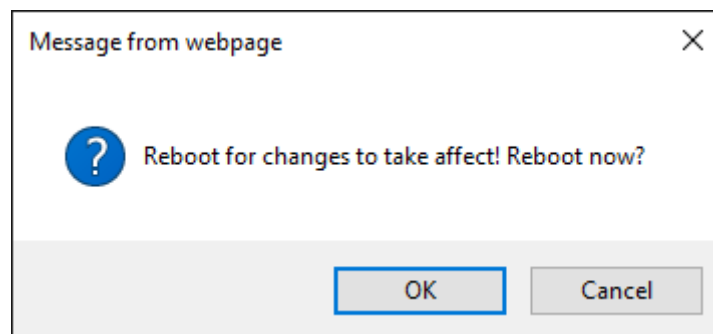

Figure 57: Request to Reboot in Web Browser

It is done like this here, you may reboot then, or do that later when the configuration is finished.

6.1.2 Telnet Configuration

Start your Telnet software with the IP Address of the NetCom⁺ as the parameter. In most configurations you use the standard port for Telnet, so you omit this parameter. As an example this is the command-line in Windows, which you may enter in Start⇒Run, or in a console (DOS box).

```
C:\Windows\System32>Telnet 192.168.254.254 23
```

For completeness the port is shown in this command. Enter the configured parameter when the port is different. If the NetCom⁺ is password protected, you need to enter the password right now.

```
Please enter your password: █
```

Figure 58: Password Request in Telnet

When connected to NetCom⁺ you must define the type of terminal used. Most Telnet software includes an emulation of a VT100 terminal, so choose this option. Also choose this option for an ANSI emulation.

```
Please choose your terminal type (1:VT100 2:VT52 [1]): 1
```

Figure 59: Select Terminal Type in Telnet

The configuration with Telnet is menu-driven.

```
+----- NetCom Plus - 811 WLAN V3.0.1 -----+
|  ServerConfig      SerialPorts      Tools      Save&Exit      |
+-----+

Server configuration settings

+----- h=HELP --+
```

Figure 60: Main Menu of Configuration Console in Telnet

This is the start point for configuration. **ServerConfig** has all options to configure the NetCom⁺ device itself, including the IP-Parameters to access it. **SerialPorts** defines settings related to the serial port. **Tools** has some utilities like PING or displays statistics. In **Exit** you may leave the menu or reboot the NetCom⁺. At any time you can get a short hint by typing "H" for help.

Use the cursor keys to select the parameter you want to change. Hit <Enter> to edit them. Type the new value, or select provided options. Use <Esc> to leave a parameter or menu. Please check the configuration of your Telnet, if there are any problems.

6.1.3 Serial Configuration

In some situations it may be impossible to get network access to the NetCom⁺ Device. If this happens (e.g. by an accidentally misconfiguration), neither Telnet, nor the web interface is functional. It may be even impossible to use the NetCom⁺ Manager program.

In this case you must connect to the NetCom⁺ via the serial port. Disconnect any serial cable from NetCom⁺. Set the DIP Switches to "RS 232 Configuration" (all switches to Off, section 3.1). Then connect the NetCom⁺ with your computer using a Null Modem cable. If your NetCom⁺ is an old model with a connector DB9 female, attach the supplied Null-Modem Adapter to the port first. Or connect your computer to the female connector with a straight-through cable.

Open any serial terminal program (Hyper Terminal, minicom, PuTTY⁶, ...), select 38400 bps, 8 Bit, No Parity as configuration. Set your terminal to emulate a VT100 (recommended, but VT52 is also possible), including the Arrow keys.

Then power on the NetCom⁺. When connected to NetCom⁺ you must define the type of terminal used (VT100 or VT52), and optionally provide the password. This is the same configuration option as described above at [Telnet Configuration](#), so follow the instructions for Telnet.

When the configuration is done, change the DIP Switches back to normal operation. Later configurations can be done by web interface or Telnet. Of course this requires to have a functional IP configuration defined.

6.1.4 SNMP Configuration

NetCom⁺ can be also configured using the SNMP protocol. This can be useful if you want to change various settings from your software or script. Starting from version 3.4.8 firmware archives provide a folder `snmp` holding management information base (MIB) definition files and related documentation:

- `VSCOM-MIB.txt` - general configuration
- `RS-232-MIB-rfc1659.txt` - serial port settings
- `EEE802dot11-MIB.txt` - WLAN settings
- `README.md` - Net-SNMP installation instructions and usage examples

⁶Download PuTTY from putty.org

6.2 NetCom Configuration Options

Some of the menus are very long, especially on the web interface. These are divided in their logical sections throughout this document. Each section shortly mentions the way to access the parameters. Short screen shots show the typical display when configuring the NetCom⁺. Usually the web interface is shown on top, and the terminal interface (Telnet, serial port) is shown below; a horizontal line divides the two. On few occasions the two screen shots are displayed side by side, with the web interface to the left and the terminal interface to the right; then divided by a vertical bar.

6.2.1 Server Configuration

In your web browser click on the Icon of “SERVER CONFIGURATION”, the browser opens the basic server information, the server parameters related to the IP-configuration, the parameters for Wireless communication, the section for encrypted communication, Password settings, and finally the configuration for date and time.

In Telnet the **ServerConfig** offers the IP parameters, Wireless and encrypted configuration, Password settings, configuration for date and time, as well as basic server information.

6.2.1.1 Server Info

Web: menu “SERVER CONFIGURATION”, section “Server Info”.

Telnet: “ServerConfig”, option “Info”

Server Info

| | |
|-------------------------|--|
| Server Type | Plus 813 |
| Software Version | 3.4.7 <input type="button" value="Check for new Version"/> |
| Hardware Version | 4.3 |
| Serial Nr. | 0220101644 |
| UpTime | 27 day(s) 03:30:14 |
| Contact ⓘ | <input type="text" value="<unset>"/> |
| Location ⓘ | <input type="text" value="<unset>"/> |

```

ServerConfig
+-----+
| Parameter |
| Wireless  |
| OpenVPN   |
| Modbus GPIO |
| Authentication |
| Date & Time |
| Info      |
+-----+

```

```

Server Info

Server Type           Plus 813
Software Version      3.4.7
Hardware Version      3.1
Serial Nr.            0220101644

UpTime                27 day(s) 03:30:14

Contact               [<unset> ]
Location              [<unset> ]

```

Figure 61: Server Information

Information about the selected NetCom⁺ is displayed as “Server Info”. Starting with the **Server Type**, this is the model of the NetCom⁺, followed by the **Software Version** and **Hardware Version**. This will give a rough overview, which features are implemented, or need an upgrade of the firmware. The **Serial Nr.** is important to identify the device you are configuring right now. For further information the **UpTime** is listed.

Contact and **Location** are user-defined information. They may later help to find the device in the installation, and the person responsible for management. The Administrator may provide some contact information here.

Contact defines a person to contact for help, e.g. "Mrs. Jane Doe, 555-HELP". **Location** is the physical place of the NetCom⁺, e.g. "CeBIT Hall 12, Service Box IX.a". These data are restricted to ASCII characters.

The button named **Check for new Version** is an option to perform an online check for later firmware versions. If one is available it is possible to install it directly, without prior download and manual upgrade via the **Tools** menu (see 6.2.3.5 on page 98). This function requires access to the Internet for NetCom⁺.

Latest firmware version 3.4.7:

- **fixed mode switching bug**

(a) Latest Firmware Information

This version is already installed!



(b) Update available

(c) Firmware up to date

Figure 62: Upgrade-Check

The NetCom⁺ displays information on the latest version of the firmware. Occasionally an update is available, you may choose to install that from here. But usually the latest version is already installed.

6.2.1.2 Server Parameter

Web: menu “SERVER CONFIGURATION”, section “Server Parameter”.

Telnet: “ServerConfig”, option “Parameter”

The **Server Parameter** allow configuration of the NetCom⁺s name and of course all parameters in IP-settings. The **Server Name** is used as general information, e.g. in the NetCom Manager program. On a NetCom Plus with WLAN option you may choose the network **Interface Priority** as **Cable**, **Wireless** or both (priority **Cable**, **Wireless** or **Wireless**, **Cable**).

Server Parameter

**Warning: for changes like network settings
the server must be rebooted**

| | |
|----------------------------|--|
| Server Name ⓘ | <input type="text" value="NetCom_0220101644"/> |
| MAC Address | 74:6A:8F:00:63:C8 |
| DHCP ⓘ | <input type="text" value="Disabled"/> |
| IP Address ⓘ | <input type="text" value="192.168.1.234"/> |
| Netmask ⓘ | <input type="text" value="255.255.255.0"/> |
| Broadcast ⓘ | <input type="text" value="192.168.1.255"/> |
| Gateway ⓘ | <input type="text" value="192.168.1.1"/> |
| DNS ⓘ | <input type="text" value="213.209.99.202"/> |
| Domain ⓘ | <input type="text" value="visionsystems.de"/> |
| ConfigPort ⓘ | <input type="text" value="23"/> |
| PrintServerPort ⓘ | <input type="text" value="515"/> |
| KeepAlive ⓘ | <input type="text" value="Off"/> |
| KeepAliveInterval ⓘ | <input type="text" value="0"/> |
| UPnP Broadcast ⓘ | <input type="text" value="On"/> |

Figure 63: Server Parameter Web Interface

| ServerConfig | Server Parameter |
|----------------|------------------------------------|
| Parameter | Server Name [NetCom_0650100420] |
| Wireless | MAC Address 74:6A:8F:00:1D:7A |
| OpenVPN | Options auto |
| Modbus GPIO | Interface Priority Cable, Wireless |
| Authentication | DHCP Enabled |
| Date & Time | IP Address 192.168.1.249 |
| Info | Netmask 255.255.255.0 |
| | Broadcast 192.168.1.255 |
| | Gateway 192.168.1.1 |
| | DNS 192.168.1.3 |
| | Domain visionsystems.de |
| | ConfigPort [23] |
| | PrintServerPort [515] |
| | KeepAlive Off |
| | KeepAliveInterval [0] |
| | UPnP Broadcast On |

Figure 64: Server Parameter Telnet Interface

Manual changes of IP parameters are only available with **DHCP** set as **Disabled**. When DHCP is not used, enter **IP Address** and **Netmask**, as well as the **Broadcast** address. **Gateway** is required, if there are Routers in the network. **DNS** is used to access other stations by name. The **ConfigPort** is used to access the NetCom⁺ for administration via Telnet. It is suggested to use the standard value for Telnet, TCP port number 23. However it may be changed for different purposes. This does not change the function of the Telnet menus.

The firmware can operate each serial port as Print Server. The TCP Port defined by RFC1194 (mostly referred to as »Line Printer Daemon«) is 515, under certain circumstances you may change the **PrintServerPort**. More about Print Server function at the configuration of the serial ports ([6.2.2.2.8 on page 92](#)).

KeepAlive is an intrinsic function of the TCP/IP protocol. If used it causes network traffic, traditionally intended to prohibit automatic shut-down of Dial-Up network equipment. In a LAN this traffic usually is not a problem. If this functions is **On**, you must define a **KeepAliveInterval** given in seconds. As a side effect of the traffic network problems are detected earlier. NetCom⁺ has a better chance to react on network problems, or failed hosts. Even dropping an old connection may be useful in certain environments. It is suggested to activate this function when using RAW TCP communication ([6.2.2.2.2](#), [6.2.2.2.3](#)), with an interval of about 180 seconds.

As mentioned in section [Configure the Operation Modes](#) the NetCom⁺ announce their presence via UPnP protocol, to allow very easy detection and access to the configuration options. If the related data transfer on the network really has to be avoided this function may be disabled. The option of **UPnP Broadcast** exists to perform this configuration. Bear in mind afterwards a detection of the NetCom⁺ requires physical access to the network segment where the NetCom⁺ is installed to use the NetCom Plus Manager (see section [5 on page 52](#)).

6.2.1.3 Wireless Parameter

Web: menu “SERVER CONFIGURATION”, section “Wireless Parameter”.

Telnet: “ServerConfig”, option “Wireless”

This section is, of course, only available on the NetCom Plus with WLAN option class of devices, or when the external WLAN kit is installed. To operate a Wireless device, a lot of parameters are required. The configuration in the NetCom⁺ is reduced to a small set of them, for ease of configuration.

Wireless Parameter

Chipset TI WL18XX

SSID ?

OperationMode ?

CountryRegion ?

Channel ?

Encryption Type ?

Encryption Key ?

ServerConfig

```

+-----+
| Parameter |
| Wireless |
| OpenVPN   |
| Modbus GPIO |
| Authentication |
| Date & Time |
| Info      |
+-----+
```

| | |
|-----------------|----------------------|
| Chipset | TI WL18XX |
| SSID | [NetCom_0650100420] |
| OperationMode | AP |
| CountryRegion | ETSI (1-13) |
| Channel | 7 |
| Encryption Type | Off |
| Encryption Key | [empty] |

Figure 65: Wireless Parameter

The **Chipset** is provided as a read-only parameter. This defines the hardware base for the WLAN functions. This model of NetCom Plus with WLAN option supports the TI WL18XX circuits.

SSID is the «Service Set Identifier». This is used to get access to radio cells established by an Access Point. By default the NetCom⁺ operates as an Access Point and uses an SSID built from the serial number. This means it is the same as the default NetCom⁺s name.

The **OperationMode** is selectable as **AP** for «Access Point Mode», and **infra** for «Infrastructure Mode».

The mode of **AP** is the factory configuration, here the NetCom Plus with WLAN option operates as an Access Point by itself. Computers and other WLAN stations connect to it, and via the NetCom⁺ to each other. This supports Windows 7 and later versions, were the classic mode of Ad-hoc operation has been removed. Also some modern hardware does not support the insecure Ad-hoc mode anyway. The NetCom⁺ doesn't provide a DHCP server therefore both the NetCom⁺ and the connecting device must have static IP addresses of the same subnet.

The other mode named **infra** is required to connect as a client to an Access Point. Other wireless stations such as a PC or Laptop use that Access Point to transfer the data to the NetCom⁺.

Using these two modes, one can create a direct WLAN bridge between two NetCom⁺ devices, i.e., one device in AP mode and the other connects to it in **infra** mode. Both devices must have static IP addresses of the same subnet, as was mentioned before.

WLAN as of IEEE 802.11 b/g/n defines fourteen possible Channels (i.e. predefined frequencies) to use with WLAN devices. Some of these frequencies are restricted in certain countries. Please check with your local regulations for the channels you are entitled to use. This manual is just informative, it is in no way a reproduction of local regulations. The available **CountryRegion** values are FCC(1-11) for North America, ETSI(1-13) for Europe in general, SPAIN(10-11), FRANCE(10-13) and MKK(14) in Japan. Late information indicate even in Spain and France the full range of ETSI is now legal; check yourself. In Infrastructure Mode the NetCom⁺ adapts to the configuration of the Access Point. Be sure to have the correct Country/Region to match the parameters of the Access Point. The Access Point must broadcast the SSID, otherwise the NetCom⁺ will not contact it.

The **Channel** is used in AP mode. Depending on the Country Region the selection is restricted. In Infrastructure Mode this value is defined by the Access Point, and NetCom⁺ will use the same.

EncryptionType defines the encryption of the radio transmission. It may be configured as **Off**, **WEP**, **WPA-PSK/TKIP**, **WPA2** or **WPA-Enterprise**.

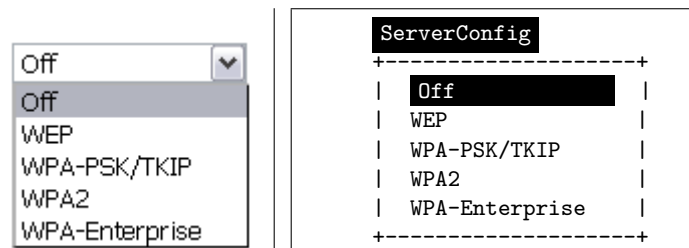

Figure 66: Wireless Encryption Modes

The WEP encryption may use 40 or 104 bit keys, sometimes also named WEP40/64 or WEP104/128. Which of this is required is defined by the **EncryptionKey** Parameter. This key may be entered as ASCII characters, or as hexadecimal for a binary key. A string with 5 characters results in WEP40 using an ASCII key. Using 10 characters as key defines this key as also WEP40, but with a binary key in hexadecimal notation. Likewise a 13 character string is WEP104 with ASCII, and 26 characters select WEP104 with a binary key.

WPA Encryption is available using TKIP cypher, and WPA2 uses AES. The key is PSK (a Pre-Shared Key) and must be installed on all stations. The ASCII password consists of 8 to 63 characters, and is mixed with the SSID to generate the key.

It is recommended to use WPA/WPA2 with a key generated from random data. As with all encryption options, a strong key is required for protection. The Internet provides a little help and background information.

WPA-Enterprise authorizes against a Radius Server. In this case, the Encryption Key is replaced by a combination of Identity (Username) and a Password.

6.2.1.4 Encrypted Communication

Web: menu “SERVER CONFIGURATION”, section “OpenVPN Parameter”.

Telnet: “ServerConfig”, option “OpenVPN”

There is a special way for encrypted communication with the NetCom Plus Serial Device Server. This function establishes an encrypted VPN tunnel between your computer and the NetCom⁺. All communication to the NetCom⁺ uses this new connection. No application requires a change of operation or source code, but seamlessly gets the advantages of Encryption. This may be especially useful to get secure communication via an otherwise insecure Wireless LAN.

To build this tunnel NetCom⁺ uses the Open Source product OpenVPN™⁷. To configure the VPN function, NetCom⁺ requests to upload a standard configuration file.

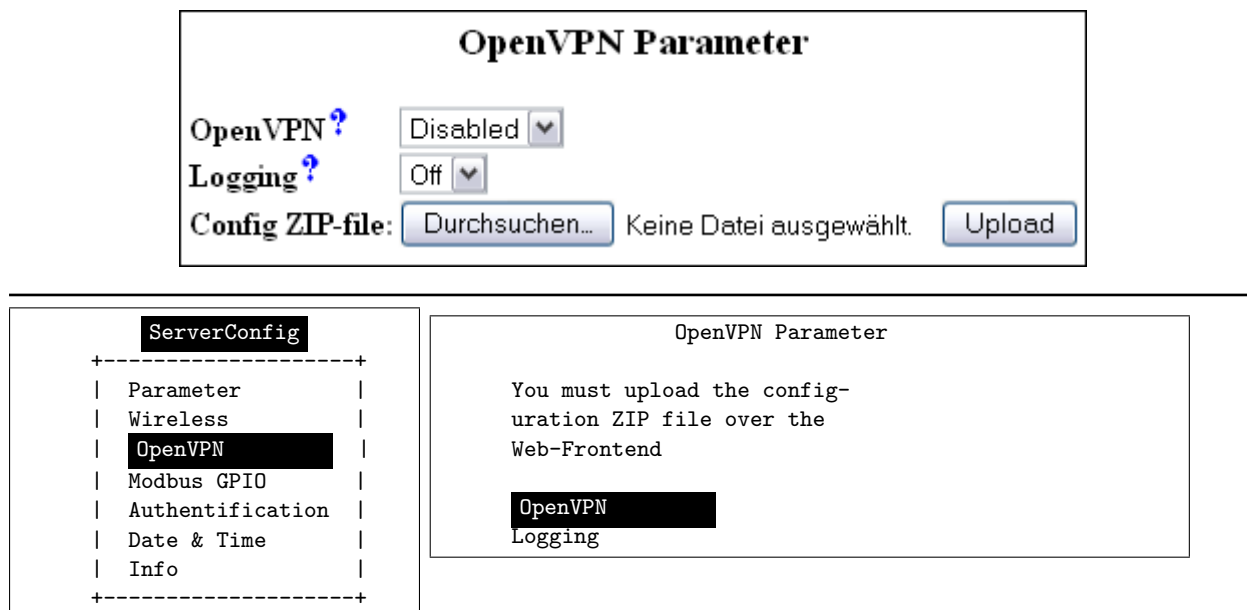

Figure 67: OpenVPN Network Parameter

Of course **OpenVPN** may be **Disabled** or **Enabled**. When the function is active, the NetCom⁺ is virtually invisible on the IP Address defined in “Server Parameter” (6.2.1.2). It will still answer on ICMP, and also the Logging function is available for trouble shooting. But there is only one connection accepted by the NetCom⁺, to the **TCP Port** defined for OpenVPN™. When used as a VPN client, no connection at all is accepted.

Nothing more is available for security reasons.

If **Logging** is **On**, NetCom⁺ sends the messages of OpenVPN™ to the standard debug log output.

Details on configuration of OpenVPN are given in the separate chapter 10 on page 119.

6.2.1.5 viaVPN Remote Management and Access

Web: menu “SERVER CONFIGURATION”, section “viaVPN Parameter”.

Telnet: “ServerConfig”, option “ViaVPN”

Encrypted communication by OpenVPN may be used to provide access via Internet and Firewalls or on mobile networks, with minor effort. But it requires deep knowledge about network operation

⁷<http://openvpn.net> (Community)

and configuration of OpenVPN in particular. Further it needs certain network configuration, either at the NetCom⁺ location or in the LAN of the connecting PC. Yet another alternative would be a private server for OpenVPN, available in public Internet. All this may be difficult to configure and a lot of effort, especially for connecting to just a few NetCom⁺ devices.

To ease such installations the models of NetCom⁺ provide access to the viaVPN system. The required infrastructure and knowledge is provided by viaVPN, users just use it. This option is described in the separate chapter [11 on page 128](#). Also how to activate this option is specified in that chapter.

Through viaVPN's reliable hardware, sophisticated cloud software and intuitive web-based management interface it empowers you to deliver a complete after-sales service supporting Remote Management, Remote Diagnostics, Remote Troubleshooting and Remote Maintenance.

Web-based user interface makes the service management much easier: you don't need to hire a team of IT professionals to install, deploy, maintain, and upgrade the infrastructure and software. Even non-technical users can process and manage the viaVPN solution with just a few mouse-clicks, which lets you build up your cloud-based support team without incurring elevated costs or long waiting times.

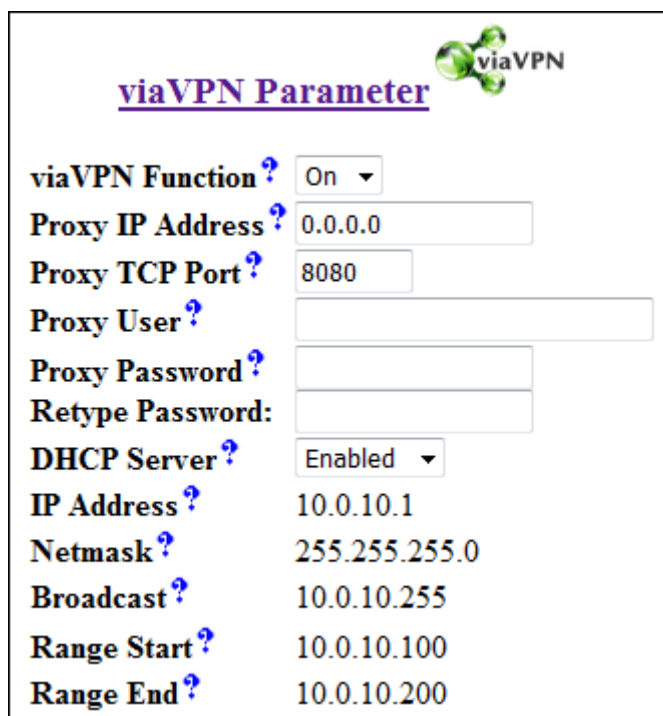

viaVPN Parameter

viaVPN Function ? On ▾

Proxy IP Address ? 0.0.0.0

Proxy TCP Port ? 8080

Proxy User ?

Proxy Password ?

Retype Password:

DHCP Server ? Enabled ▾

IP Address ? 10.0.10.1

Netmask ? 255.255.255.0

Broadcast ? 10.0.10.255

Range Start ? 10.0.10.100

Range End ? 10.0.10.200

| ServerConfig | viaVPN Parameter |
|----------------|----------------------------|
| Parameter | Proxy IP Address [0.0.0.0] |
| Wireless | Proxy TCP Port [8080] |
| OpenVPN | Proxy User Name [] |
| ViaVPN | Proxy Password [] |
| Modbus GPIO | DHCP Server Enabled |
| Authentication | IP Address [10.0.10.1] |
| Date & Time | Netmask [255.255.255.0] |
| Info | Broadcast [10.0.10.255] |
| | Range Start [10.0.10.100] |
| | Range End [10.0.10.200] |

Figure 68: viaVPN Network Parameter

The first parameters are to configure the access of NetCom Plus to the Internet, so it can establish the connection to the Rendezvous Server. Many installations do not require configuration at all, then there is no need for special parameters. But in case such is required, the NetCom⁺ uses a web proxy for https access, in the same way as any Internet Browser in the network does this.

The **Proxy IP Address** is either the address or the name (like proxy.network.local). The value of 0.0.0.0 disables this function, which is the default. The **Proxy TCP Port** is used to get access to the proxy function. In rare configurations the operation of the Proxy requires an identification, the **Proxy User Name** and the **Proxy Password** serve for this. Your Network Administrator will provide you with all necessary values.

For easy administration of connections via the PC Client Utility the NetCom Plus provides a DHCP Server. This will assign a valid configuration to the Client Utility connection to the viaVPN system. As the result the Client PC can connect to the NetCom⁺, and perform management operations. The following parameters configure the operation of the DHCP Server.

Important Note: These parameters here do not influence the configuration in the local network (LAN). They are effective only on the connection established by the Client Utility.

The **DHCP Server** may be Disabled. But Enabled is the default and strongly recommended. **IP Address**, **Netmask** and **Broadcast** are properties of the NetCom⁺ side of the viaVPN connection. They behave in the same way as the parameters in the Server Configuration, see paragraph 6.2.1.2 on page 67. **Range Start** and **Range End** are the first (lowest) and last (highest) value the DHCP Server will assign to the Client PC side of the viaVPN connection.

6.2.1.6 Node-RED GUI Programming

Node-RED⁸ is a programming tool for wiring together hardware devices, APIs and online services in new and interesting ways.

It provides a browser-based editor that makes it easy to wire together flows using the wide range of nodes in the palette that can be deployed to its runtime in a single-click.

Initial Node-RED installation already provides a lot of useful functions like sending/receiving UDP/TCP packets, working with HTTP/MQTT and other protocols. The framework can also be extended via various third-party modules (see this collection⁹) and as Node-RED is written around Node.js¹⁰ you can access any Node.js modules via “function” node or create your own Node-RED nodes¹¹.

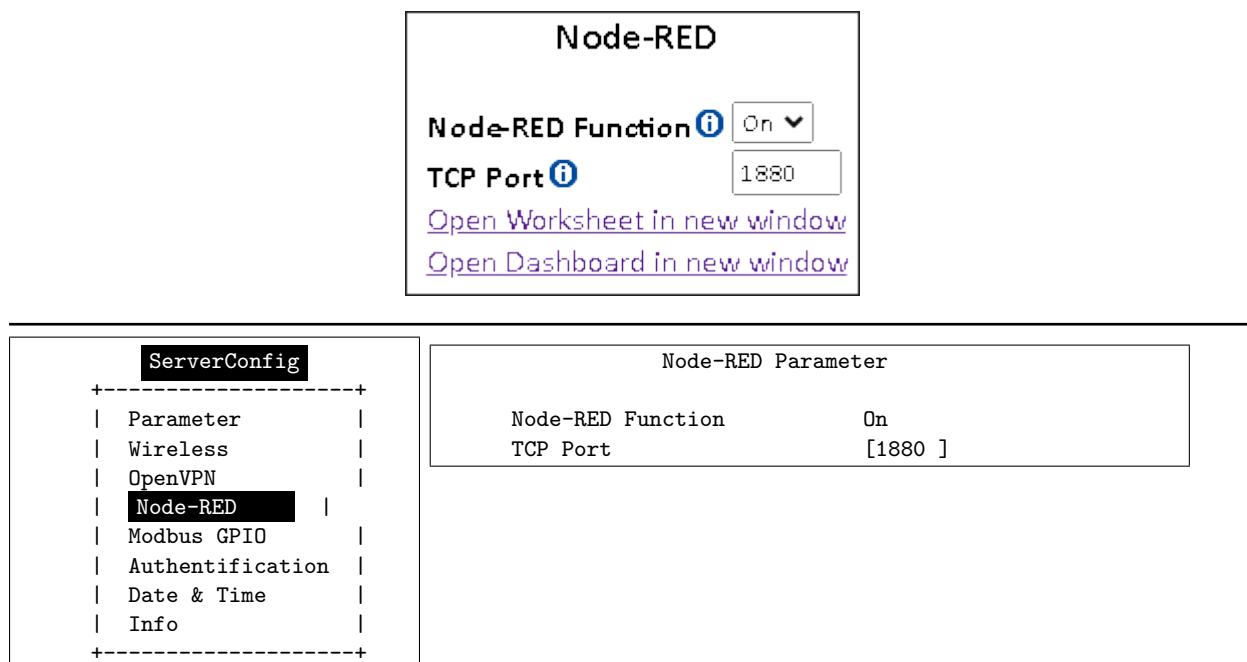

Figure 69: Node-RED Parameter

As default, the Node-RED support is disabled and you must switch it explicitly on. Note, that Node-RED itself takes a little longer to start, after the green ready LED lites up on the NetCom Plus. You can change the default port to a value of your choice on which the Node-RED service

⁸<https://nodered.org>

⁹<https://flows.nodered.org/>

¹⁰<https://nodejs.org/en/>

¹¹<https://nodered.org/docs/creating-nodes/>

is listening. To open Node-RED’s worksheet, click the link in the NetCom Plus web-frontend or visiting the URL directly over *http://<IP address>:1880/*. You can click the other link for Node-RED’s dashboard or browse to the UI over the link *http://<IP address>:1880/ui*.

You will find detailed information about usage and configuration in our OnRISC IoT manual ¹².

6.2.1.7 Modbus GPIO

This function is only available on the NetCom Plus 811 DIO device server. The signals are controlled via Ethernet/Internet using Modbus/TCP. This protocol has TCP port 502 defined as standard for operation, but it may be changed to a different value if the network configuration requires this. The communication software must know the IP Address and TCP port.



Figure 70: Modbus/TCP Network Parameter

The details of operating the input and output signals are specified in section 12 on page 131. The connection scheme for the signals, and their electric properties is given in section 3.5 on page 29.

¹²https://www.vscom.de/download/multiio/OnRISC/Baltos/OnRISC_IoT_Manual.pdf

6.2.1.8 Authentication

Web: menu “SERVER CONFIGURATION”, section “Authentication”.

Telnet: “ServerConfig”, option “Authentication”

Figure 71: Access Authentication

The Security Settings define a **Password** to restrict access to the configuration of NetCom⁺. The password is not shown while typing it. To protect against accidental mistyping, you must type the Password twice.

6.2.1.9 Date & Time

Web: menu “SERVER CONFIGURATION”, section “Date and Time Settings”.

Telnet: “ServerConfig”, option “Date & Time”

It may be helpful to have a correct time setting in the NetCom⁺. You may manually enter the time here. Please note, there is no battery backup for the real time clock in the NetCom⁺. When the NetCom⁺ loses power the time is lost, a reboot by web interface or the Reset button should retain the current time. Retype the value of **Date & Time** for manual setting. The format is DD-MM-YYYY HH:MM:SS UTC+/-TZ (Time Zone).

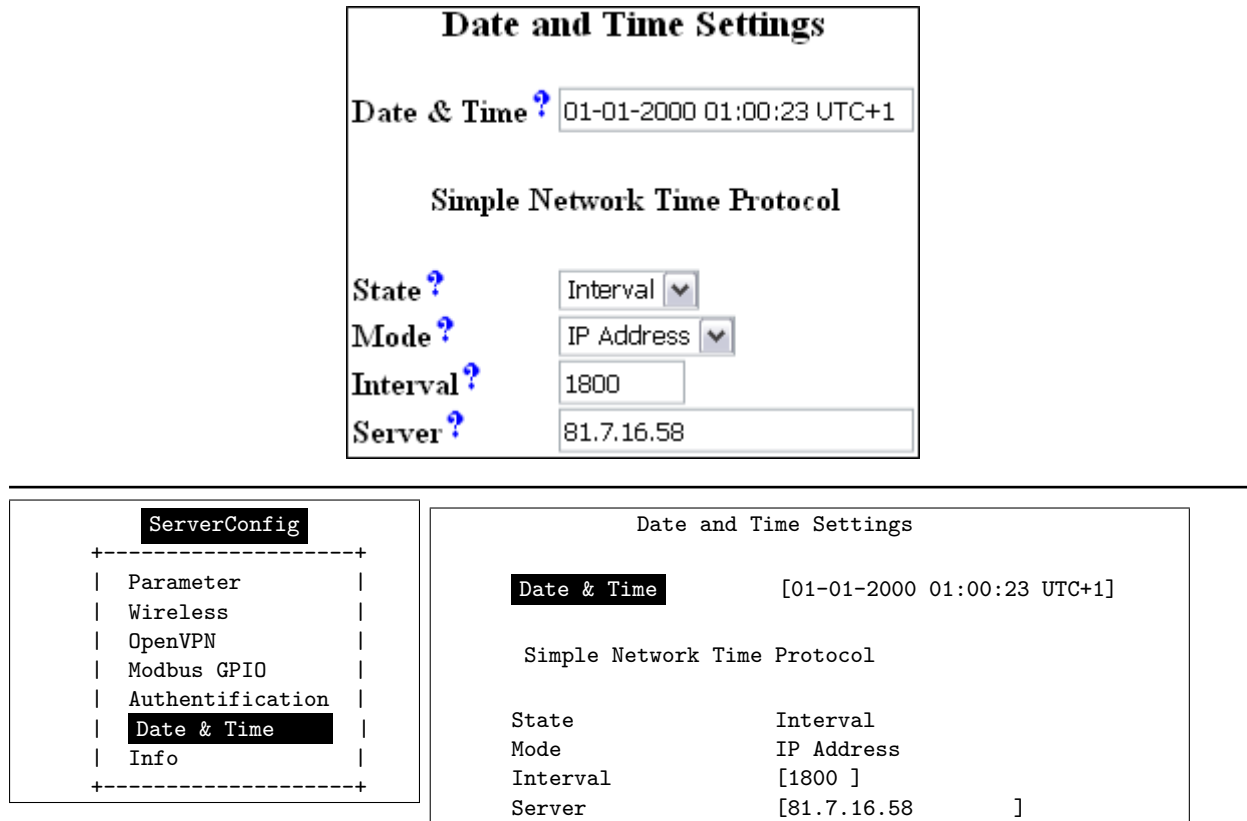

Figure 72: Date & Time Retrieval Options

It is possible to configure NetCom⁺ for automatic time retrieval via SNTP.

The **State** field has three possible settings:

- **Off**: disables automatic time retrieval.
- **Startup**: NetCom⁺ gets the time at reset or power on.
- **Interval**: NetCom⁺ repeats to retrieve time.

The parameter **Mode** is used to find the definition of the Time Server. In current firmware the time source is defined by the **IP Address**.

The **Interval** in seconds instructs the NetCom⁺ to regularly check for an update of the internal time settings. The Time **Server** may be given by IP Address or by name. A name of course requires a configured DNS server¹³.

¹³see at Server Parameter [6.2.1.2](#)

6.2.1.10 Save

Web: menu “SERVER CONFIGURATION”, at bottom.



At the bottom of the web page below all the options there is the button **Save**. This will store all configurations done here in the NetCom⁺. Selecting a different configuration section from the menu may discard all changes done. For many configuration changes the NetCom⁺ requires a reboot to proceed, especially if the IP parameters have been updated.

The Telnet section has a separate menu for saving configurations, described later.

6.2.2 Serial Port Configuration

In your web browser click on the Icon of “SERIAL CONFIGURATION”. This is a huge menu in the web browser. Each serial port of the NetCom⁺ is listed in a separate Column. A maximum of four serial ports is shown at one time. Select the appropriate group of ports.

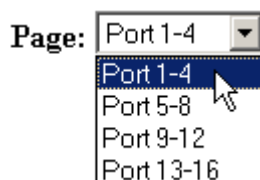

Figure 73: Port Page Selection in Web Browser

The top half of the parameters titled “Serial Settings” is directly related to common serial configurations. The bottom half titled “Transfer Settings” configures the operation mode of NetCom⁺ on the network. Each serial port is configured separately, there is no setting shared between ports.

Note: The list of serial ports will automatically expand, when supported USB-COM Plus module(s) are detected. With two or more modules always have the connection scheme the same. Otherwise physical ports will change numbers, and the configuration will be confused.

In the Telnet menu select “SerialPorts” in the Main Menu, and directly select the serial port to configure.

The settings available in this menu are by port. Therefore, first the port to configure has to be chosen.

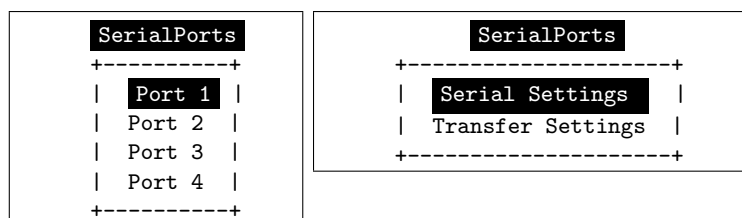

Figure 74: Port Selection in Telnet

Just select the port by placing the cursor, and then press <Enter>. The next option is to configure the **Serial Settings** or the **Transfer Settings**.

6.2.2.1 Serial Settings

Web: menu “SERIAL CONFIGURATION”, column “Port N”, “Serial Settings”.

Telnet: “SerialPorts”, select “Port N”, “Serial Settings”

The NetCom+ devices allow to operate in RS422/485 modes. This is configured by the Master DIP switches or by software, **PortType (current)** displays the current setting.

Port 1

PortType (current) rs232

Baud Base 60000000

PortType (i) rs232 ▾

Baudrate (i) 115200 ▾

Manual (i) 115200

FlowType (i) None ▾

DataBit (i) 8 ▾

Parity (i) None ▾

StopBit (i) 1 ▾

RxTimeout (i) 1

| Serial Settings | |
|--------------------|----------|
| Port Nr. | 1 |
| PortType (current) | rs232 |
| Baud Base | 60000000 |
| PortType | rs232 |
| Baudrate | 38400 |
| Manual | 38400 |
| FlowType | None |
| DataBit | 8 |
| Parity | None |
| StopBit | 1 |
| RxTimeout | [1] |

Figure 75: Serial Settings

If the DIP switches are set for «Selected by Software», the mode of operation is chosen by the **PortType** parameter with following selections:

rs232 ▾

rs232

rs422-4-wire

rs422-4-wire-termination

rs485-4-wire

rs485-2-wire

rs485-4-wire-termination

rs485-2-wire-termination

```

+-----+
| rs232
| rs422-4-wire
| rs422-4-wire termination
| rs485-4-wire
| rs485-2-wire
| rs485-4-wire-termination
| rs485-2-wire-termination
+-----+
                    
```

Figure 76: Operation Mode by Software

These are the same modes as available by configuration of DIP Switches. Using software configuration each port is functional independent from other ports. This is the only way to have different operation modes on a multi-port NetCom⁺.

When the NetCom⁺ is used via the Virtual Com Driver mode, the following serial parameters are controlled by the application which opened the serial port. However certain installations use a different operation without Driver mode. Then the serial parameters must be defined via this configuration section.

The **Baudrate** may be selected in a drop-down list of common values, or entered manually. If **Manual** is selected in the list, the value in the respective field is used to transmit data. NetCom⁺ checks if the configuration is possible, and warns otherwise. Note: The **BaudBase** is shown for reference only, it is not necessarily an achievable bitrate. **DataBit** per character, **Parity** and **StopBit** are quite usual parameters. The **FlowType** is available as standard configuration. But there is also the option of **Advanced Configuration**.

| Advance | | |
|---------------|----------------------------------|----------------------------------|
| | On | Off |
| AutoCTS | <input checked="" type="radio"/> | <input type="radio"/> |
| AutoRTS | <input type="radio"/> | <input checked="" type="radio"/> |
| AutoDSR | <input type="radio"/> | <input checked="" type="radio"/> |
| AutoDTR | <input type="radio"/> | <input checked="" type="radio"/> |
| AutoTxXOnXOff | <input checked="" type="radio"/> | <input type="radio"/> |
| AutoRxXOnXOff | <input type="radio"/> | <input checked="" type="radio"/> |

| FlowType Configuration | |
|------------------------|-----|
| Port Nr. | 1 |
| AutoCTS | off |
| AutoRTS | off |
| AutoDSR | off |
| AutoDTR | off |
| AutoTxXOnXOff | off |
| AutoRxXOnXOff | off |

Figure 77: Advanced Flow Control

This gives very specific control to the user. NetCom⁺ can generate Events on RTS, DTR or as XON/XOFF, when the serial receive buffer is filled/emptied. These will inform the connected device to stop or continue the transmission. The NetCom⁺ will also respect the state of CTS, DSR or XON/XOFF when sending data to the connected serial device.

Since firmware version 3.4.1 the time to wait for further data is configurable, defined by the value of **RxTimeout**. Depending on the actual configuration of the serial port the time to transfer a character differs, so the timeout is defined as amount of characters. The default value of '1' sends the received data very quick, but might split serial messages in smaller chunks. If this happens a value of about '3' (three) is appropriate, to wait if the serial message is continued. Only when the time represented by this value has passed without further data, the collected buffer is sent as one block to the PC. A value of '0' sends received data over the network as quick as possible.

6.2.2.2 Transfer Settings

Web: menu “SERIAL CONFIGURATION”, column “Port <N>”, “Transfer Settings”.

Telnet: “SerialPorts”, select “Port <N>”, “Transfer Settings”

The Transfer Settings allow different operation modes. They are selected by the basic **Mode** setting. Depending on the current mode, only some of the many parameters are useful. The web configuration hides those parameters without function.

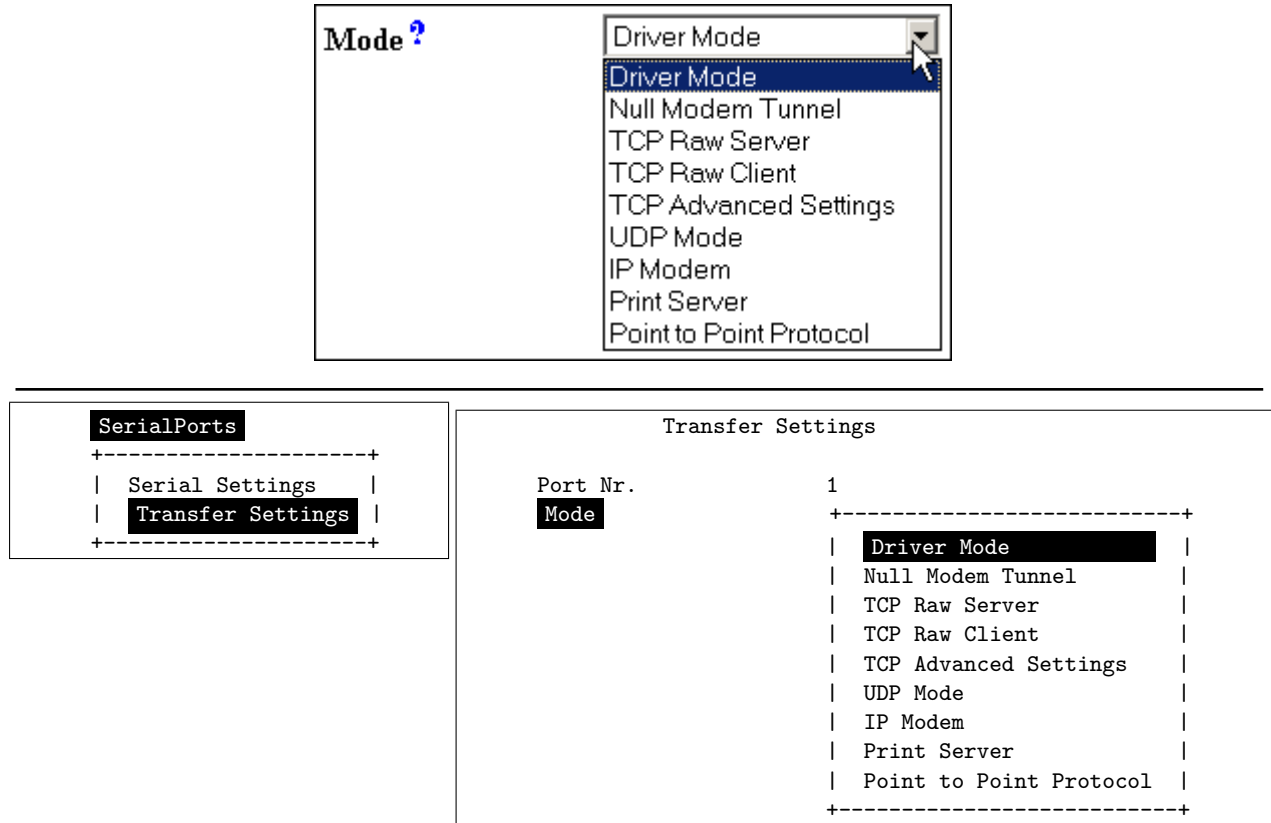

Figure 78: Serial Port Mode Selection

The following paragraphs explain these operation modes as well as their parameters and configuration in detail.

6.2.2.2.1 Driver Mode Only very few parameters have a function in Driver Mode. NetCom⁺ is operating as a Server in TCP mode, it accepts two connections per serial port. This mode is required when the driver software for Virtual Com Ports shall be used.

| | |
|---------------------|-------------|
| Mode ? | Driver Mode |
| TCP Port(Control) ? | 2000 |
| TCP Port(Data) ? | 2001 |
| KeepAliveMode ? | On Connect |
| KeepAliveInterval ? | 0 |

| | |
|-------------------|-------------|
| Mode | Driver Mode |
| TCP Port(Control) | [2000] |
| TCP Port(Data) | [2001] |
| KeepAliveMode | On Connect |
| KeepAliveInterval | [0] |

Figure 79: Driver Mode parameters

The first connection is used to transmit the serial data, this is the **TCP Port (Data)**. And the other is used to transmit control information, **TCP Port (Control)**. This control connection includes the configuration of the serial port, as well as signals for changed Modem Status lines. This mode is required when the serial port is operated via the Virtual Com Driver, it is the default.

In Driver Mode the NetCom⁺ accepts only one client per serial port. An attempt to connect a second client is actively refused. This is required to avoid confused configurations and data on the serial port.

The NetCom⁺ can monitor an open connection. This is controlled by the **KeepAliveMode**, which has three settings: **Off**, **On Connect** and **Polling**.

- **Off**: never send KeepAlive packets.
- **On Connect**: when a client is trying to connect to the server and there was a connection before, the server checks if the first connection still exists. If it does not exist anymore, the server accepts the new connection.
This option is the default configuration.
- **Polling**: the server checks in **KeepAliveInterval** (seconds), if a connection still exists.

If the network connection between client and NetCom⁺ seems to be unstable, the configuration of **Polling** may be desired. This way the NetCom⁺ may detect when the connection got lost. When the NetCom⁺ detects a lost connection, this is discarded, so the NetCom⁺ is available for other clients. Disabling the check is not recommended.

6.2.2.2.2 TCP Raw Server As Raw Server the NetCom⁺ operates very simple. It only waits for incoming data connections in Raw IP mode. In contrast to the Driver Mode no driver software needs to be installed on client computers, this mode operates directly on the TCP/IP stack in the operating system. The parameters of the serial port are defined on the NetCom⁺, as given above (3.1).

| | |
|-------------------------|----------------|
| Mode ? | TCP Raw Server |
| TCP Port(Data) ? | 2001 |
| Max.Clients ? | 1 |
| Password ? | |
| Retype Password: | |

| | |
|-------------------|------------|
| Mode | Raw Server |
| TCP Port(Control) | [2000] |
| Max.Clients | [1] |
| Password | [*****] |

Figure 80: TCP Raw Server parameters

Compared to the Driver Mode only the data connection is defined by the **TCP Port(Data)**. The **Max.Clients** parameter allows for more than one connection to the NetCom⁺ at a time. If the number is raised, it is the responsibility of the customer to ensure correct operation. There is no special Keep Alive option, the global parameters from section 6.2.1.2 apply.

The firmware can handle an additional protection by **Password**. When a password is configured, the NetCom⁺ sends the question "Password: " to the client. The user (his application) must first send the password, followed by a <CR> character. The password is not echoed to allow usage with Telnet on a Monitor.

6.2.2.2.3 TCP Raw Client Also as Raw Client the NetCom⁺ requires very few parameters. The client computer operates via the TCP/IP stack as in 6.2.2.2.2, but now the computers waits for incoming connections opened by the NetCom⁺. Using this mode several NetCom⁺ may connect to the same server software installation. The parameters of the serial port are defined on the NetCom⁺, as given above (3.1). When the client computer is another NetCom⁺ in TCP Raw Server mode, this will virtually connect the devices attached to the serial port.

| | |
|---------------|---------------------|
| Mode | Raw Client |
| Destination | [192.168.1.5:2001] |
| Connect | Triggered |
| ShortHoldTime | [0] |

Figure 81: TCP Raw Client parameters

Under certain conditions the NetCom⁺ establishes a Raw TCP connection to a pre-defined Destination. The **Destination** can hold multiple hosts as targets for a connection. They are entered as a comma separated list of DNS names or IP Addresses. Each destination will have a TCP port number, separated by a colon. Instead of a single IP Address or DNS name, a range of IP Addresses is also valid. This range must be followed by the TCP port number, as in 192.168.254.12-192.168.254.17:2077.

The parameter **Connect** defines if NetCom⁺ uses the connections as **Permanent**, **Triggered** or by **DSR**. With **Permanent** the NetCom⁺ attempts to open the connection as soon as it is available. In **Triggered** mode any activity on the serial ports establishes the connection, inactivity of longer than the **ShortHoldTime** cause NetCom⁺ to close the connection. With **DSR** the TCP-connections follow the state of the DSR signal at the NetCom⁺ serial port. When it becomes active they are established, until DSR becomes inactive. At that moment the connections are dropped.

6.2.2.2.4 Null Modem Tunnel This operation mode is intended to build a long virtual Null Modem Cable between the serial ports of two NetCom⁺. This mode is symmetric, both NetCom⁺ operate as server and as client at the same time. The parameters of the serial port are defined on the NetCom⁺, as given above (3.1).

| | |
|----------------------------|-------------------|
| Mode ? | Null Modem Tunnel |
| Server | |
| TCP Port(Control) ? | 2000 |
| TCP Port(Data) ? | 2001 |
| Client | |
| Destination ? | |
| TCP Port(Control) ? | 2000 |
| TCP Port(Data) ? | 2001 |
| Connect ? | Triggered |
| ShortHoldTime ? | 0 |
| KeepAliveMode ? | On Connect |
| KeepAliveInterval ? | 0 |

| | |
|-------------------|-------------------|
| Mode | Null Modem Tunnel |
| Server | |
| TCP Port(Control) | [2000] |
| TCP Port(Data) | [2001] |
| Client | |
| Destination | [] |
| TCP Port(Control) | [2000] |
| TCP Port(Data) | [2001] |
| Connect | Triggered |
| ShortHoldTime | [0] |
| KeepAliveMode | On Connect |
| KeepAliveInterval | [0] |

Figure 82: Null Modem Tunnel

This is a mixed mode, requiring parameters for server function and for the client part. The NetCom⁺ operates as a server while accepting connections in Driver Mode (6.2.2.2.1). If there is no current connection, the NetCom⁺ may establish a connection as a client. This is also a special connection, using the Driver Mode protocol. NetCom⁺ will not only transmit serial data in both directions, it will also pass information about the current settings of the Modem Status lines. And it will itself set the Modem Control lines as required by the other host. The CTS is connected to the RTS of the partner, and DSR connects to DTR. Since this operation requires another NetCom⁺ to accept the connection, both NetCom⁺ together operate as a long Null-Modem cable. The data is sent via a tunnel through the network.

The configuration as **Server** (top part) requires the same parameters as the Driver Mode, hence **TCP Port (Control)** and **TCP Port (Data)**. Also the **KeepAlive** function operates the same.

The configuration as **Client** (bottom) first requires a destination. Here it is given by name, but a direct IP Address may be more usual. On the destination there is also a **TCP Port (Control)** and **TCP Port (Data)** to accept the connect of the NetCom⁺.

The **Connect** methods are the same as with the TCP Raw Client mode. So connections to the partners are permanent, last until there is no activity for a given time, or they are controlled by the DSR signal.

Attention: You *must not* configure both NetCom⁺ with a **Connect** option configured as **Permanent**. This will result in each of them attempting to contact the other at the same time. Both NetCom⁺ will reject the connect, because they are already busy establishing a connect of their own. Instead create an asymmetric configuration: either use one of the NetCom⁺ in Driver Mode, or configure it with an empty Destination parameter. Or consider to have a connection on demand, i.e. use the **Triggered** option.

6.2.2.2.5 TCP Advanced Settings All of the above operation modes are special configurations for options. In some situations none of the pre-defined modes fit the customers needs. When this is the case, the TCP Advanced Settings offer the configuration of any Transfer parameter. Unusual combinations of Modes are possible with this, also standard modes with unusual parameters.

| | |
|----------------------------|-------------------------|
| Mode ? | TCP Advanced Settings ▾ |
| Server ? | Off ▾ |
| TCP Port(Control) ? | 0 |
| TCP Port(Data) ? | 2001 |
| Max.Clients ? | 1 |
| Client ? | On ▾ |
| Destination ? | |
| TCP Port(Control) ? | 0 |
| TCP Port(Data) ? | 0 |
| Connect ? | Triggered ▾ |
| ShortHoldTime ? | 0 |
| KeepAliveMode ? | On Connect ▾ |
| KeepAliveInterval ? | 0 |

| Transfer Settings | |
|-------------------|-----------------------|
| Port Nr. | 1 |
| Mode | TCP Advanced Settings |
| Server | On |
| TCP Port(Control) | [2000] |
| TCP Port(Data) | [2001] |
| Max.Clients | [1] |
| Client | Off |
| Destination | [] |
| TCP Port(Control) | [2000] |
| TCP Port(Data) | [2001] |
| Connect | Triggered |
| ShortHoldTime | [0] |
| KeepAliveMode | On Connect |
| KeepAliveInterval | [0] |

Figure 83: TCP Advanced Settings

The NetCom⁺ usually acts as a network server. This means it accepts incoming connections. The most used Driver Mode is one example. The NetCom⁺ detects which mode to use. When the Data-Port is opened first, then the NetCom⁺ operates in TCP Raw Server mode, with respect to **Max.Client**. When the Control-Port is opened first, the NetCom⁺ expects a second connection on the Data port, to operate in Driver Mode for one client only.

The NetCom⁺ can also operate as a network client as seen in TCP Raw Client mode. This is enabled by setting **Client** to **On**. As a client it requires the same parameter as for the specialized modes. When the **TCP Port(Control)** is defined (not zero), the NetCom⁺ will operate as a client for Driver Mode, as in Null Modem Tunnel. The destination is the target address or DNS name.

Otherwise the NetCom⁺ operates in TCP Raw Client mode when it establishes a connection. The syntax for multiple destinations applies then.

The remaining parameters are explained in the client mode descriptions.

The TCP Advanced Settings allow for flexible usage of the NetCom⁺, when **Server** and **Client** modes are **On** at the same time. If no connection is active with the NetCom⁺, it accepts incoming connections, i.e. it operates as server as long as the connections are held. Without a connection a Trigger event defined in **Connect** cause the NetCom⁺ to establish a connection to the defined target. So the NetCom⁺ is a client at that time.

6.2.2.2.6 UDP Data Transfer UDP is an Internet Protocol, which does not define a connection, it sends data in single packets instead of a stream. There is no extra return data to signal a successful transmission. As a side effect, data may be sent and received faster than with TCP/IP.

| | |
|-------------------|----------|
| Mode | UDP Mode |
| UDP Port(Local) | [2002] |
| Destination | [] |
| UDP Port(Dest) | [2002] |
| UDP MaxPacketSize | [1458] |
| UDP Timeout | [30] |
| UDP Trigger | [] |

Figure 84: UDP Data Transfer

This protocol requires a **UDP Port(local)** for listening to incoming data. Other stations on the network send their data to this port. The **Destination** host is configured by IP Address or name, plus the target **UDP Port(Dest)**. Please compare with the parameters for TCP Raw Server and Client Modes. The parameters to configure the UDP Mode are similar to a mixture of these modes. A UDP Broadcast is sent, if the destination address is the broadcast Address, see section 6.2.1.2 above.

To use multicast, add “#m” or “#M” at the end of the IP address. With this NetCom⁺ joins a multicast group via the Internet Group Management Protocol (IGMP). The “#m” sets the multicast TTL to 1 and the “#M” sets it to 100.

Since there is no connection, data can not be sent in a stream. UDP uses packages. There are several ways to define the content for a package.

UDP MaxPacketSize is a limit for the size of UDP packets. When the amount of data received on the serial port reaches this limit, the UDP Frame is assembled and sent to the destination.

UDP Timeout defines when the NetCom⁺ sends the received data as a UDP Frame. If the reception of serial data is interrupted for this time (in milliseconds), the data sampled so far is sent to the destination. A value of zero causes all data to be sent immediately, use “-1” to disable the function of timeout trigger. A good value to start with is 30, if no specific parameters are given by the external devices. This is the default since firmware version 3.3.5

UDP Trigger defines a sequence of characters. As soon as this sequence is detected in the received data, all data up to the end of this Trigger is sent to the destination. In most situations such a Trigger includes control or other special characters. Enter them numeric: as \xHH where HH is the hexadecimal code of the character, or as \OOO where OOO is the octal code of the character. The backslash itself must be doubled as \\.

If none of these options is used, the packets definition is not specified. This will result in unpredictable separation of serial data, depending on internal hardware behavior. Typically this is not handled good by the application software.

6.2.2.2.7 IP-Modem The serial port of a NetCom⁺ may mimic (emulate) a serial modem. There is the separate section 8 defining this functionality. Here are the basic network parameters only.

The screenshot shows a configuration window with four fields:

- Mode ?**: A dropdown menu currently set to "IP Modem".
- TCP Port(Data) ?**: A text input field containing the value "2001".
- Destination ?**: An empty text input field.
- IP Modem Config ?**: An empty text input field.

| | |
|-----------------|----------|
| Mode | IP Modem |
| TCP Port(Data) | [2001] |
| Destination | [] |
| IP Modem Config | [] |

Figure 85: IP-Modem

A serial modem accepts connections from a phone line, while an IP Modem accepts connections from the network, in this case via TCP/IP. The TCP port for this is defined as the **TCP Port (Data)**, similar to TCP Raw Server mode. This is the only parameter required to set here.

All other values are normally defined by AT-commands via the serial port. However for short, **Destination** allows for up to four predefined targets, available with special Dial commands. The **IPModemConfig** is known as the Init String in standard modems.

6.2.2.2.8 Print Server Function The NetCom⁺ firmware allows the function as a Print Server according to RFC1179, also called a »Line printer daemon«. A print server is accessed through its IP Address via one specified TCP Port (see section 6.2.1.2). Data is handled in distinct queues, each with a certain name. Each queue is handled by a certain serial port, and the data is sent to the serial printer attached to this port.

| | |
|-------------|--------------|
| Port Nr. | 1 |
| Mode | Print Server |
| QueueName | [lpd1] |
| InitString | [] |

Figure 86: Print Server Configuration

Each serial port configured for Print Server operation has its separate **QueueName**. The default value is »lpd« plus port number. The **InitString** is a special feature of NetCom⁺. This string is sent to the serial printer at the beginning of the next queued print job. The definition is in section 9.2.1 on page 113.

6.2.2.3 Save

Web: menu “SERIAL CONFIGURATION”, at bottom.



Again at the bottom of the web page below all the serial port options there is the button **Save**. This will store all configurations done for the current group of serial ports. Selecting a different group of ports or another configuration section from the menu may discard all changes done.

6.2.3 NetCom Tools

Several tools for system status, checks and debugging are available in the Firmware. The available tools are:

- The Ping utility to check if a station is available.
- Statistic information for each serial port.
- The Netstat utility to monitor used TCP connections.
- The option to detect WLAN devices in the proximity (NetCom Plus with WLAN option only)
- The option to update the firmware.
- Saving of Configuration to / Loading from a file (web browser only).
- Information logging by Syslog function and a DebugLog via TCP/IP.

In your web browser click on the Icon of “TOOLS”, the browser opens the list of available tools. In Telnet the “Tools” menu provides a list of the tools.

6.2.3.1 Ping

Web: menu “Tools”, section “Ping”.

Telnet: “Tools”, option “Ping”.

Enter the **IP Address** or the name of a station in the field. In the web browser click the **Ping** button, hit the <Enter>-key via Telnet. The network connection is checked by sending ICMP Echo Request data packages.

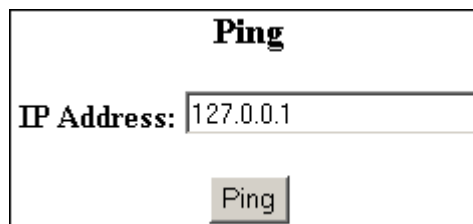

```
PING 127.0.0.1 from 192.168.1.87 : 44 (72) bytes of data
52 bytes from 127.0.0.1: icmp_seq=0 ttl=255 time=1.560 msec
52 bytes from 127.0.0.1: icmp_seq=0 ttl=255 time=1.542 msec
52 bytes from 127.0.0.1: icmp_seq=0 ttl=255 time=1.542 msec
back
```

Figure 87: Ping and Response in Web Browser

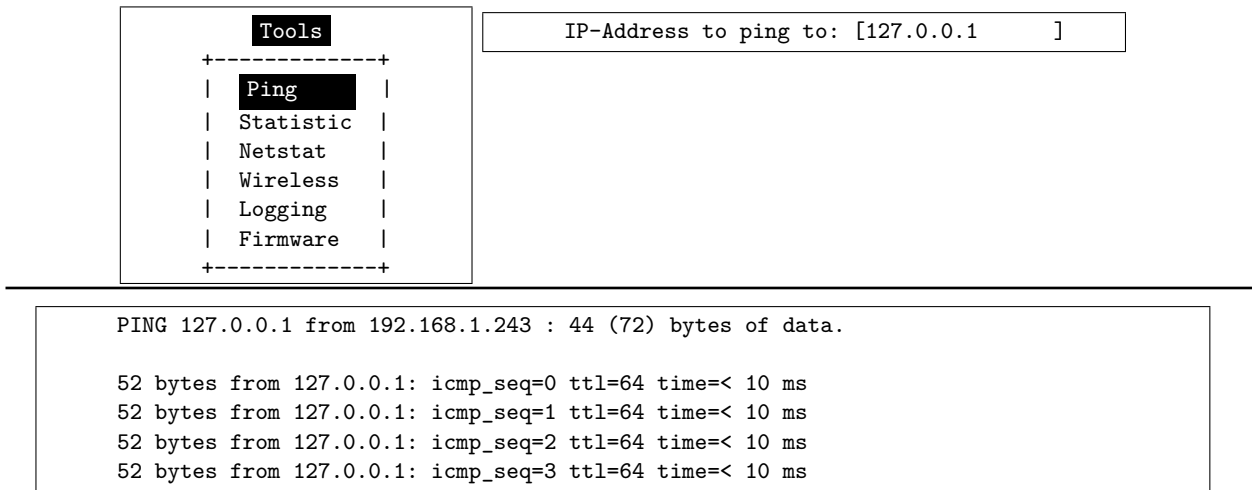

Figure 88: Ping and Response in Telnet

If the target responds, the network between the NetCom⁺ and the target is operational. The time required for an echo depends on the speed of the network. In a typical Ethernet this is only very few Milliseconds, while it can be several seconds throughout the Internet.

Via Telnet use the <Esc>-key to stop the Ping function.

6.2.3.2 Statistics

Web: menu “Tools”, section “Statistics”.

Telnet: “Tools”, option “Statistics”.

The Statistics are presented on a by-port base. So you first select the serial port, and then you get the information about modem status and control. Also the amount of data transferred is shown.

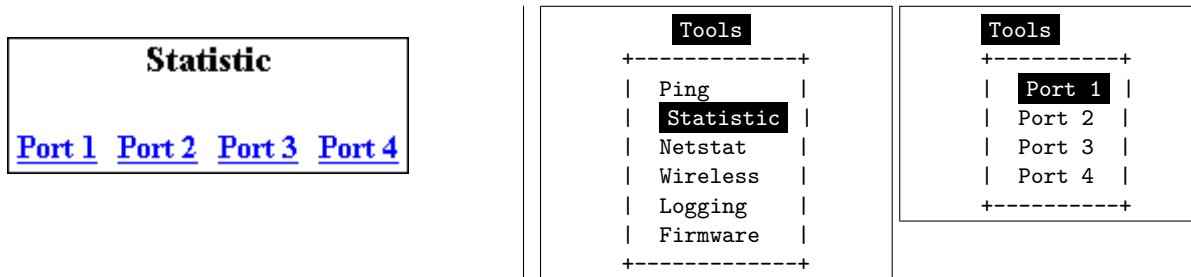

Figure 89: Statistics Port Selection

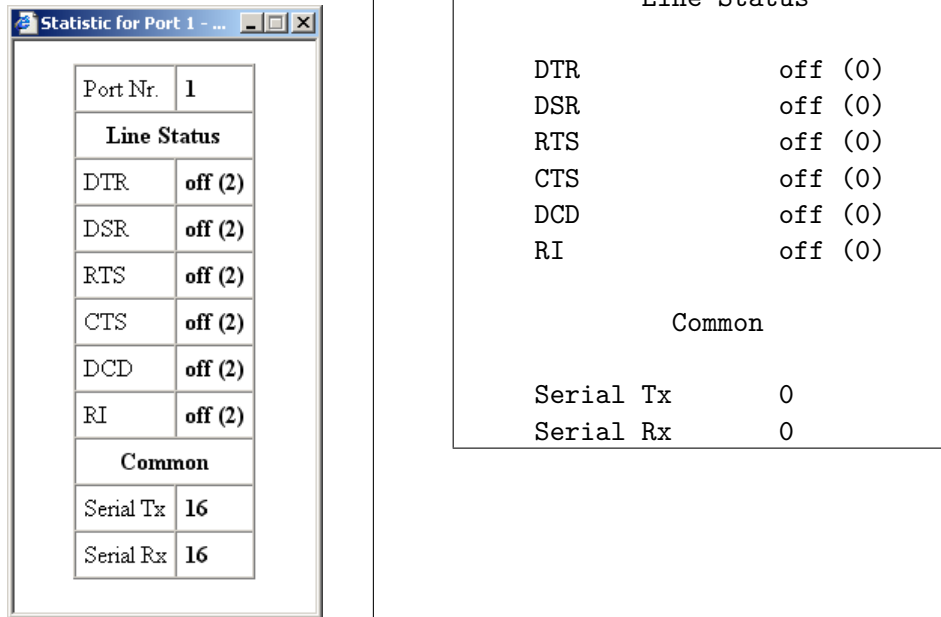

Figure 90: Port Statistics

The statistics window¹⁴ reports the state of the modem status and control signals. Further the NetCom⁺ counts the number of status changes on the modem control- and status-signals, since the NetCom⁺ has been started. The number of characters sent and received is shown at the bottom.

6.2.3.3 Netstat

Web: menu “Tools”, section “Netstat”.

Telnet: “Tools”, option “Netstat”.

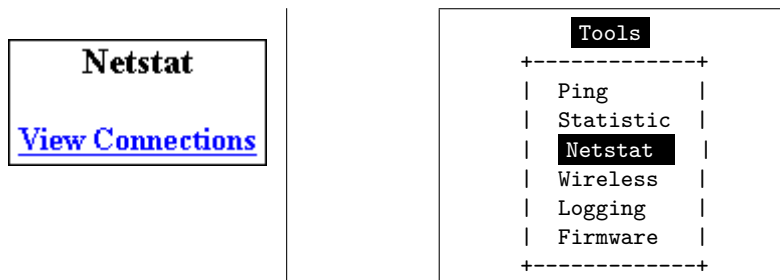

Figure 91: Start Netstat

¹⁴The web browser opens a separate window for each port selected

| Update | | | |
|------------------------|---------------------|-------------------|-------------|
| Proto | Local Address | Foreign Address | State |
| tcp | 0.0.0.0:23 | 0.0.0.0:0 | LISTEN |
| tcp | 0.0.0.0:80 | 0.0.0.0:0 | LISTEN |
| tcp | 0.0.0.0:2000 | 0.0.0.0:0 | LISTEN |
| tcp | 0.0.0.0:2001 | 0.0.0.0:0 | LISTEN |
| tcp | 0.0.0.0:2010 | 0.0.0.0:0 | LISTEN |
| tcp | 0.0.0.0:2011 | 0.0.0.0:0 | LISTEN |
| tcp | 0.0.0.0:2020 | 0.0.0.0:0 | LISTEN |
| tcp | 0.0.0.0:2021 | 0.0.0.0:0 | LISTEN |
| tcp | 0.0.0.0:2030 | 0.0.0.0:0 | LISTEN |
| tcp | 0.0.0.0:2031 | 0.0.0.0:0 | LISTEN |
| tcp | 192.168.1.243:80 | 192.168.1.42:1280 | TIMEWAIT |
| tcp | 192.168.1.243:80 | 192.168.1.42:1281 | ESTABLISHED |
| udp | 0.0.0.0:161 | | |
| udp | 0.0.0.0:19970 | | |
| udp | 192.168.1.243:32331 | | |

(a) In Web Interface

| 1/1 | | | |
|-------|--------------------|-------------------|-------------|
| Proto | Local Address | Foreign Address | State |
| tcp | 0.0.0.0:23 | 0.0.0.0:0 | LISTEN |
| tcp | 0.0.0.0:80 | 0.0.0.0:0 | LISTEN |
| tcp | 0.0.0.0:2000 | 0.0.0.0:0 | LISTEN |
| tcp | 0.0.0.0:2001 | 0.0.0.0:0 | LISTEN |
| tcp | 0.0.0.0:2010 | 0.0.0.0:0 | LISTEN |
| tcp | 0.0.0.0:2011 | 0.0.0.0:0 | LISTEN |
| tcp | 0.0.0.0:2020 | 0.0.0.0:0 | LISTEN |
| tcp | 0.0.0.0:2021 | 0.0.0.0:0 | LISTEN |
| tcp | 0.0.0.0:2030 | 0.0.0.0:0 | LISTEN |
| tcp | 0.0.0.0:2031 | 0.0.0.0:0 | LISTEN |
| tcp | 192.168.1.98:23 | 192.168.1.42:3665 | ESTABLISHED |
| udp | 0.0.0.0:161 | | |
| udp | 0.0.0.0:33320 | | |
| udp | 192.168.1.98:10397 | | |

(b) In Telnet

Figure 92: Netstat Sample Output

Netstat is a common tool to display the actual status of network connections. It may be used to monitor the actual status of the NetCom⁺. This is a standard tool for network debugging.

A 'Foreign Address' of "0.0.0.0" is listed when NetCom⁺ is waiting for an incoming connection (LISTEN mode). If the value is not "0.0.0.0", the connection is either active (ESTABLISHED) or already closed (TIMEWAIT).

In the web browser you may **Update** the Netstat output.

Via Telnet the output may not fit on the screen, then the display will start with "1/2" in the first line. Or even more for a long list. You may change to a different page by using the Page Up/Down keys in your Telnet. The display is refreshed in an interval of some seconds. Use <Esc>-key to return to the menu.

6.2.3.4 Wireless

Web: menu “Tools”, section “Wireless”.

Telnet: “Tools”, option “Wireless”.

When Wireless communications is intended, it is useful to see a list of possible partner stations on the WLAN. This function is available in many driver packages for Windows, and also in the NetCom Plus with WLAN option Serial Device Servers. This detection is often referred to as »Range Scan«.

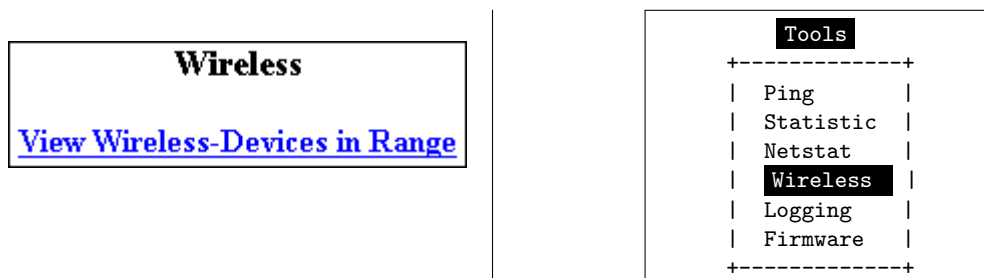

Figure 93: WLAN Scan

On the NetCom Plus with WLAN option it will open a separate browser window with the results. An example of this is shown below. Telnet displays the results.

| Wireless-Devices in Range Update | | | | | |
|--|-------------------|-------------------|---------|---------|-----|
| Act | MAC | SSID | Channel | Mode | Enc |
| X | 86:73:F6:22:E1:BA | NetCom_0210100462 | 7 | Ad-Hoc | |
| X | A6:E8:9E:BE:7D:86 | NetCom_0210100444 | 7 | Ad-Hoc | |
| X | 00:0F:B5:66:CF:56 | NETGEAR | 11 | Managed | X |
| Current Rate: 11Mb/s | | | | | |

| Act | MAC | SSID | Ch | Mode | Enc |
|----------------------|-------------------|-------------------|----|---------|-----|
| X | 86:73:F6:22:E1:BA | NetCom_0210100444 | 7 | Ad-Hoc | |
| | A6:E8:9E:BE:7D:86 | NetCom_0230100152 | 7 | Ad-Hoc | |
| X | 00:0F:B5:66:CF:56 | NETGEAR | 11 | Managed | X |
| Current Rate: 11Mb/s | | | | | |

Figure 94: WLAN Scan Output

This example lists two other NetCom configured for Ad-Hoc communication on channel 7. Both do not use encryption. There is also an Access Point (listed as **Managed**), of course in Infrastructure-mode. To connect to this AP the NetCom Plus with WLAN option must use encryption.

In Telnet the display is updated automatically when some information changes. Most noticeably this will be the Act-ivity sign.

6.2.3.5 Firmware

Web: menu “Tools”, section “FirmwareUpdate”.

Telnet: “Tools”, option “Firmware”.

To upload a new version of the firmware, put the name of the file in the field. Your web browser will allow to search for the file. Click on the **Update** button, and your browser will upload the file to the NetCom⁺.

FirmwareUpdate

Warning: All connections get closed
and the server reboots after updating

Tools

```

+-----+
| Ping   |
| Statistic |
| Netstat |
| Wireless |
| Logging |
| Firmware |
+-----+

```

Firmware Update

Update Port [2400]

[Start Update]

Figure 95: Firmware Upload

Via Telnet the option to upgrade the Firmware of NetCom⁺ is different. The upload of the data is either done via the current channel (i.e. the serial or Telnet connection). Or independently via a separate TCP/IP connection. The **Update Port** parameter defines this second connection, the NetCom⁺ waits for a TCP connection on this port. The Firmware is sent coded in base64 (a special text format), via very simple programs like a second Telnet session, or similar tools. Terminal software by serial configuration may just use the “Send Textfile” function.

While uploading the file it is checked by NetCom⁺. If it is a valid content, it is stored in the Flash Memory. When the upload is finished, NetCom⁺ will Reboot.

6.2.3.6 Save and Load Configuration

Web: menu “Tools”, section “Configuration File”.

Via web browser it is possible to save the actual configuration to a text file. Of course it is also possible to load the saved configuration into a NetCom⁺.



Figure 96: Save and Load Configuration in Web Browser

This may be very useful when configuring several NetCom⁺ of the same type. Configure one device, and save the file. Change the configuration file for the necessary parameters, and upload the modified version to the next model.

6.2.3.7 Logging and Debug

Web: menu “Tools”, section “Syslogging”.

Telnet: “Tools”, option “Logging”.

The NetCom⁺ has two options of Logging. There is the standard Syslog, and a second option of logging via Telnet.

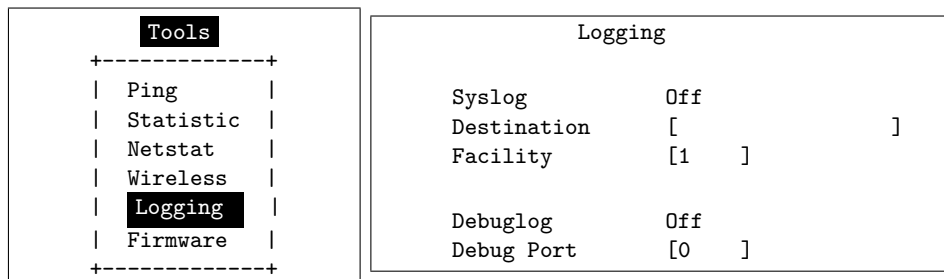
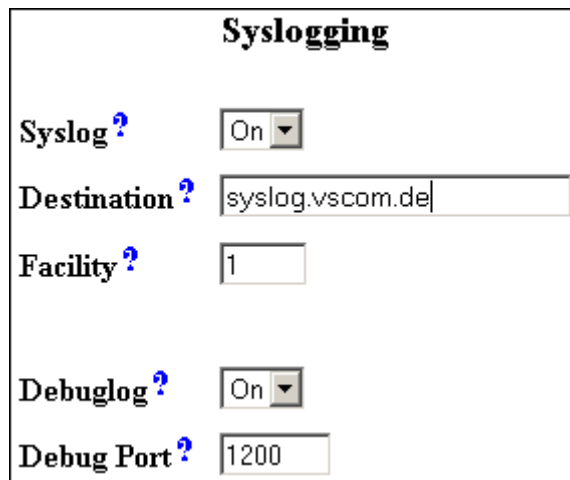

Figure 97: Syslog & Debuglog Parameters

The **Syslog** function may of course be **Off** or **On**. In the **On**-state the NetCom⁺ sends all the log information to a computer defined by **Destination**. A special software often called Syslog Daemon has to receive these data. The Option of **Facility** is a criteria for the Daemon how this will organize the data received from the NetCom⁺.

In contrast for **Debuglog** the NetCom⁺ behaves as the server. When this option is **On** the NetCom⁺ waits for incoming TCP connections to the configured **Debug Port**. The NetCom⁺ sends all logging information via this connection. For manual use a software like Telnet is suitable, especially if it has the option to save all received data.

6.2.3.8 Save

Web: menu “Tools”, at bottom.



As usual at the bottom of the web page below all the options there is the button **Save**. This will store the configurations done for Logging (6.2.3.7).

6.2.4 Reboot

Web: menu “REBOOT”.

In your web browser, click the Icon of **REBOOT** to restart the NetCom⁺ firmware.

Attention: This option will discard all configuration changes, unless they have explicitly been saved. Naturally it will also disconnect all other clients using serial ports or the Telnet configuration menu.

6.2.5 Save&Exit Menu

This section of configuration is only available via the terminal interface, i.e. via Telnet or serial port. Modifications in the configuration of the NetCom⁺ are not active, until they are explicitly saved to the Flash Memory of NetCom⁺. This menu also allows to discard all changes, and even to restart the firmware.

6.2.5.1 Save Parameter

Telnet: “Save&Exit”, option “Save Parameter”.

When some changes are done, these modified settings should be saved. A confirmation is requested before doing this.

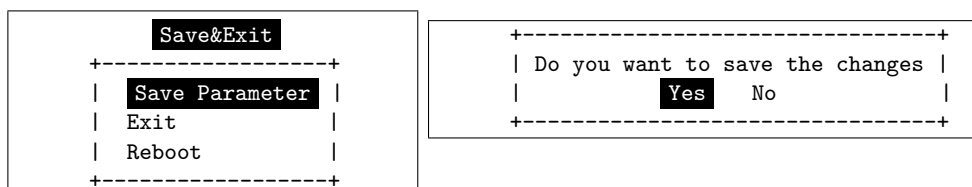

Figure 98: Menu Save modified Parameters in Telnet

The Telnet interface is still active when this operation is finished.

6.2.5.2 Exit

Telnet: “Save&Exit”, option “Exit”.

You will not be surprised, when you leave the menu by selecting this option. If you made any changes of parameters, you must confirm to save these.

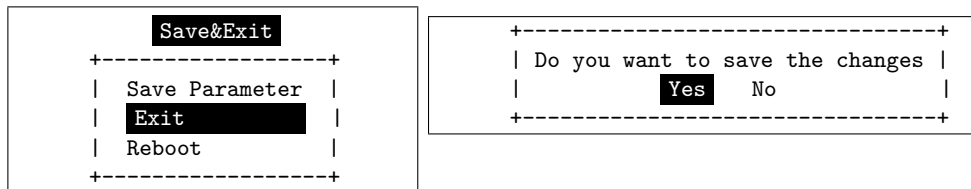

Figure 99: Menu Exit from Configuration in Telnet

The NetCom⁺ terminates the Telnet interface when this operation is finished, even when the modifications are not saved to Flash Memory.

6.2.5.3 Reboot

Telnet: “Save&Exit”, option “Reboot”.

Users may restart the firmware of the NetCom⁺. Modified configurations are activated by the restart process. Such a restart is necessary for some changes like IP configuration, others do not require a restart.

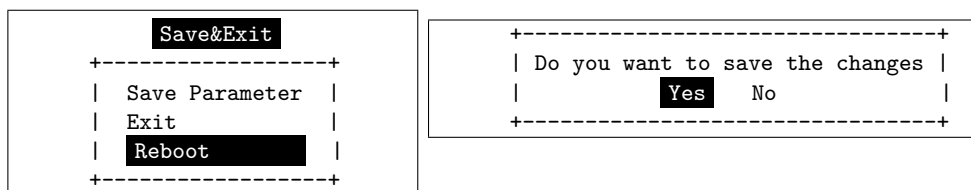

Figure 100: Exit and Reboot in Telnet

Also here, if parameters are changed during the session, confirmation for saving them is requested. Of course the Telnet configuration is closed, because all TCP connections are terminated by the reboot process.

6.3 Erase Configuration of NetCom

Sometimes it is required to clear any configuration done, and go back to the Factory Settings. Users might think this is possible with the Reset button. It is not done this way. The Reset button is just a way to restart the NetCom⁺ without removing the power.

To make a clean configuration the DIP switches must be configured to the pattern of »Factory settings«. Refer to Section 3.1 or to the table on top of the NetCom⁺ case. When this pattern is chosen, the NetCom⁺ has to be restarted, by power off or by using the Reset button. This is for security. When changing a DIP configuration, the »Factory settings« might appear by accident. So the NetCom⁺ requires to be restarted with this DIP pattern active to avoid accidental damage of the configuration. While restarting, the NetCom⁺ erases the current configuration, and replaces the parameter with the default values. When this is finished, the Power LED blinks once. Do not

power off or reset the NetCom⁺ before this blink is seen.

The Ethernet cable should not be connected, because the NetCom⁺ uses DHCP in factory configuration. Without an Ethernet cable it does not attempt to find a DHCP server, which makes for a faster reboot process.

7 Operation in Linux

In Linux there is no real tty driver available for NetCom Plus serial device servers. However for most applications this is not a problem, since Linux is very good in networking. Either the application can contact the Serial Port on the NetCom⁺ via a TCP connection, or it may use a fixed tty emulation of a serial port. In both configurations the parameters of the serial port are configured on the NetCom⁺. Additionally the serial port is operating in the mode of TCP Raw Server, with one defined TCP port to connect to (see [6.2.2.1 on page 80](#) and [6.2.2.2 on page 84](#) for details). For the following sections the IP Address 192.168.1.198 is used, with 2001 as the TCP data port number. This may be the serial port of a NetCom Plus 113 serial device server.

7.1 Via Fixed TTY Pseudo Serial Port (socat)

There are applications designed to operate via serial ports, and via this only. So they want to open a device which behaves like a serial port, usually `/dev/ttyS0` or `/dev/modem`. To create a pseudo device of this type the program `socat` may be used.

```
socat pty,link=/dev/netcom0,raw,waitslave tcp:192.168.1.249:2001&
```

This command creates a temporary pseudo tty device with the name as `/dev/netcom0`. Any name is possible, as long as it does not conflict with already existing devices. The TCP connection will be established to the serial port on NetCom⁺, but this is delayed until an application opens this `/dev/netcom0`. The connection will be established as raw (without modifying data).

The terminating '&' in the line sends `socat` into background operation. It will terminate when `/dev/netcom0` is closed by the application.

```
minicom -D /dev/netcom0
```

This command will then start the application `minicom` as an example. In this example the created `/dev/netcom0` is used, so `minicom` operates via the serial port on the NetCom⁺. Even when `minicom` attempts to configure the serial port, this has no effect on the NetCom⁺. When `minicom` is closed, the process of `socat` terminates as well. For next use `socat` must be started again, which can be done in a script also.

The specification as “Fixed TTY” defines that behavior. Applications may use the pseudo port like a serial port, but the serial configuration is fixed. Any commands to change the configuration are accepted from the application, but they do not change the serial port operation.

7.2 Via TCP Raw Server Mode

The application will use the IP Address of the NetCom⁺ with the configured TCP port number for the intended serial port. Usually the first serial port uses 2001 as TCP data port, so as an example program here is the command line for telnet application:

```
telnet 192.168.1.249 2001
```

This command will open a raw TCP connection to the NetCom⁺. This connection is raw (no modification of data) because there is no initiation of the protocol known as Telnet (RFC 854). Every byte received on the serial port is displayed on the screen. And all characters typed on the keyboard are sent via the serial port to the connected device. The serial parameters used are stored in the NetCom⁺, e.g. 38400,8,n,1 without flow control. If RTS/CTS or a different mode of flow control is configured, this is handled internally at the serial port inside the NetCom⁺.

Especially with telnet users often get confused by doubled characters on the screen. This is caused by a misconfiguration of telnet, in this case the option of local echo. The typed character is shown on the screen by telnet, and the serial device also sends back the character. The configuration of telnet is beyond the scope of this manual.

Telnet is one example, other applications will use their own methods of configuration.

8 IP Modem Function

The Firmware offers the function of IP Modem. Used in this mode, the serial port of the NetCom⁺ emulates a standard serial modem. Basically this means the NetCom⁺ will

- a) answer to AT-commands on the serial port
- b) establish a connection to a destination
- c) inform the connected serial device of the connection
- d) accept a TCP connection, and inform the serial device of that event

For connections the NetCom⁺ will use a TCP connection. This differs from a normal telephone line, so there will be some modifications in the behavior. The target is an IP Address, not a phone number. Also for hardware reasons the automatic baudrate detection used in today serial Modems is not available. However this is not a problem at all, the IP Modem can be installed in Windows as a Standard 33600bps Modem. There is an INF-file for ease of installation.

8.1 Some possible Scenarios

1. The customer has a remote management installation, operating via telephone line. These lines may be in-house or through public phone systems to other destinations. The customer wants to reduce costs for these lines, management and possibly hardware, using the Intra- or Internet.
2. The customer wants to contact several stations from a central server. Because of frequent target changes he does not want to define the target by a Virtual Com Port.
3. Remotely distributed devices contact a central system by Modem. This is the reverse of option 1.
4. A computer without Network access shall have at least limited control on the connections established by a NetCom⁺.
5. Old fashioned BBS installations become accessible via Internet. The typical multi-modem box is replaced by a NetCom⁺ Server with multiple ports configured for IP Modem operation.

8.2 Serial Signals and Cables

A real modem provides the same signals as the serial port of a PC. However, where a signal is an output on the PC, it is an input to the modem, and vice versa. So in the NetCom⁺ the emulation of a modem must be incomplete. By exchanging RxD and TxD the data connection is fine, the same happens for handshaking signals RTS and CTS. The DTR of the PC is connected to DSR of NetCom⁺, this is simple. The RI may be ignored, some connectors for serial ports also do that.

However a real modem provides DSR and DCD to the PC. There is only the DTR left on NetCom⁺ to serve these signals. In most configurations the NetCom⁺-DTR serves as the DCD to the computer.

The cable must provide a DSR to the PC then, e.g. by shortcut to the PC-DTR. In some configurations the NetCom⁺-DTR must serve as the DSR. This is configurable by a command.

The recommended cable connects as shown in this table. Please note, this installation does not use the simply crossed signals. Especially the DSR of the PC is internally connected to the DTR of the PC.

| DB9m | PC | | IP-Modem | DB9m | DB9f |
|------|-----|-----------------------------|----------|------|------|
| 3 | TxD | —— | RxD | 2 | 3 |
| 2 | RxD | —— | TxD | 3 | 2 |
| 7 | RTS | —— | CTS | 8 | 7 |
| 8 | CTS | —— | RTS | 7 | 8 |
| 6 | DSR | PC-DTR (internal loop-back) | | | |
| 4 | DTR | —— | DSR | 6 | 4 |
| 1 | DCD | —— | DTR | 4 | 6 |
| 5 | GND | —— | GND | 5 | 5 |

Table 22: IP Modem cable

The limitation of signals is a restriction in function, compared to real world serial modems. Since most installations do not require the full availability of all signals, the required subset can be selected.

8.3 Operation Modes by IP Modem

The function of IP-Modem may be configured port by port. On a NetCom⁺ with a single port there is no much of a difference. However a NetCom⁺ with more serial ports operates each port independently. In the following sections of this manual the phrase "serial port of a NetCom⁺, configured to operate as IP Modem" is replaced by "IP Modem" for brevity.

Two basic operation modes are available. The first and default mode is Modem-to-Modem. This requires a serial port of a NetCom⁺ configured as IP Modem on both ends of the connection. When one IP Modem dials the other, the connection is established on the TCP level. Directly afterward both IP Modems negotiate to ensure they are a real NetCom⁺ IP Modem and are free for connection. If successful both issue a "CONNECT . . ." response to the serial connected devices. This is convenient for the customer to understand. The CONNECT may report some parameters, e.g. the minimum serial speed used by both Modems. These extra parameters are not implemented so far.

The other mode is named as Modem-to-Host. The destination is any software, which opens a TCP port for Listen mode. It may be a second NetCom⁺ configured for TCP Raw Server Mode. It may also be the customers application, running on a certain computer. This mode offers less features.

8.4 Hayes Commands

The IP Modem operates with a command set similar to those in real Modems. All of the commands start with the character sequence AT.

8.4.1 AT command set

The following table lists many standard commands (in alphabetical order). The AT is omitted for brevity. The discussion of the functions is below the tables in section 8.5 below.

8.4.1.1 Standard AT-Commands

These commands are based on the old Hayes Modem.

| AT | Hayes-Standard | IP Modem Function |
|---------|--|--|
| A | Answer Call | Accept a connection |
| Bn | ITU-T modulation | Define some modem operation modes |
| Dnnn | Dial connection, basically phone number as nnn | Connect to the target system by IP Address and TCP-Port. E.g. ATD10,0,8,42,2023 will "dial" to port 2023 on IP Address 10.0.8.42 |
| E | Echo on/off | Enable/Disable local echo of command |
| H0 | Hang up | Terminate the TCP connection |
| I | Device Information | I0 through I9 report information |
| L | Speaker Volume | Ignored, always answered with OK |
| M | Speaker On/Off | Ignored, always answered with OK |
| N | Auto serial speed | N0 no Auto, N1 reports error |
| O | Return to data mode | |
| Q | Result Codes | Enable or disable result codes/strings |
| S=nn/S? | S-Register | Set/request configuration registers |
| V0/1 | Responses | Numeric/text responses to commands |
| X | Busy/Dial detect | Ignored, always answered with OK |
| Z | Reset to User profile | Standard |

Table 23: IP Modem Standard AT-Commands

8.4.1.2 Extended AT-Commands

These commands are used in modern modems, and have slightly different syntax depending on the model.

| AT | Standard-Extensions | IP Modem Function |
|--------|----------------------|---|
| &C | DCD control | When to turn on DCD (by IP Modems DTR) |
| &D | DTR meaning | Hang Up, Command Mode or Reset |
| &F | Load factory Default | |
| &K | Flow Control | |
| &S | DSR control | When to turn on DSR (by IP Modems DTR) |
| &V | View Profiles | |
| &W | Store Profile | &W0/&W1 is "Standard". ATZ1 loads profile 1 |
| &Zn=dd | Save for short dial | Define possible targets by DNS name or IP Address |
| %C1 | V.42bis enable | Ignored |
| \Q | Flow control | See &K |

Table 24: IP Modem Extended AT-Commands

8.4.1.3 Non-AT commands All these commands apply in Command Mode. If a Dial command or an ATA succeeds with a CONNECT, the IP Modem is in data mode. Every data received on the serial port is sent to the other station/IP Modem. And there is a special character sequence in Data Mode, which changes back to Command Mode. This sequence is '+++’ by default, with an interval of 1 second before and after this command; the three characters must appear in one second.

8.4.2 S-Registers for Configuration

Traditional there is a set of registers to control certain operations. These registers are controlled via the AT S-command mentioned above. This is a list of those supported by IP Modem.

| Reg. | Function | Range/units | Default |
|------|------------------------------|-------------------|-----------------------|
| S0 | Auto-Answer Ring | 0-255 | 0 (no Auto-Answer) |
| S1 | Ring Counter | 0-255 | 0 (read only) |
| S2 | Escape Code | 0-127 (ASCII) | 43 (= "+" for "+++") |
| S3 | Carriage Return | 0-127 | 13 |
| S4 | Line feed | 0-127 | 10 |
| S5 | Backspace | 0-32, 127 | 8 |
| S8 | Comma pause | 0-255 (seconds) | Accept but ignore |
| S9 | Carrier detect response time | 1-255 (0.1 sec) | 6 |
| S12 | Escape Guard time | 20-255 (0.02 sec) | 50 (= 1 second) |
| S25 | DTR Ready Delay | 0-255 (0.01 sec) | 5 (= 50 msec) |
| S26 | RTS to CTS Delay | 0-255 (0.01 sec) | 1 (= 10 msec) |
| S30 | Disconnect Timer | 0-90 (seconds) | 0 (read only, AT\Tnn) |

Table 25: IP Modem S-Registers for Configuration

S0 is frequently used to configure a modem to auto answer incoming calls. S1 may be checked by software if S0 is Zero, i.e. no Auto-Answer. S2 may be set to a different character, if the '+++’ may happen in typical data. Otherwise the software must insert a pause in the transmission.

8.4.3 Sample Commands used by Windows

The NetCom⁺ IP Modem is intended for manual installation as kind of a "Standard Modem" in Windows. The reference is the MDMGEN.INF file. The commands used in that file are:

```
"AT&F", "ATA", "ATH", "AT &F E0 V1 &C1 &D2 S95=47 S0=0<cr>", "ATS0=0<cr>", "ATX4",
"ATS7=<#>", "AT%C", "AT\N", "AT&K", "ATS30=<#>", "ATB", "ATDP", "ATDT", "ATL", "ATM"
```

8.5 Description of AT-Commands

The commands are listed more or less in a functional grouping. Configuration commands are listed also with their default settings in brackets.

8.5.1 AT D (dial)

This is the general Dial command. The target is defined as IP Address plus TCP-port number. The dots in the address are replaced by a comma, and the TCP port is also separated by a comma. On normal modems a comma generates a pause in the dialing sequence. This is commonly required, so all software will support it; even multiple comma.

The modifiers 'T' for Touch Tone and 'P' for Pulse dialing have no direct equivalent on the TCP connection. They are used to change between Modem and Host mode, if the ATB command enables this (ATB2 or ATB3). Otherwise the IP Modem will ignore them.

Basically dialing is done to a given IP Address plus a TCP port number. The IP Address is given in decimal Octet format, where comma replaces the dot as the separator. This is followed by another comma, separating the TCP Port from the IP Address. If the port is omitted, the target port is the same as the local TCP Data Port as defined in the configuration of IP Modem (see 6.2.2.2.7 above).

There are situations where the target is known by a DNS name. This name can not be used in a dial string, mostly because very few software will support it. So there is the option of dialing to a pre-defined entry by shortcut. This is given by an 'S' followed by one or two digits. The shortcuts S90 to S99 are reserved; so far only S1 to S4 are implemented. Shortcuts are defined and saved by 'AT&Znn=<FDN:Port>'.

All other non-numeric characters are understood as modifiers. The IP Modem will simply ignore them. This especially applies to space characters. Typically dial strings are:

| | |
|------------------------------------|---|
| ATDT192,168,254,254,2003<cr> | Dial another IP Modem as a Modem-to-Modem |
| AT&Z12=demokit.vscom.com.tw:23<cr> | Define a shortcut for configuration port |
| ATDPS12<cr> | Dial the other IP Modem as Modem-to-Host |

Table 26: IP Modem Sample Dials

8.5.2 AT O (online / data mode)

If a connection is established, the IP Modem can still be in command mode. The ATO activates the transparent data mode.

8.5.3 AT A (answer call)

Have the IP Modem answer an incoming call, and establish a TCP connection. This command is required if Auto-Answer is disabled. Observe the operation mode defined by ATB.

8.5.4 AT B (modulation) [ATB1]

This command is used to define the modulation to use on the phone line. Since the only "modulation" available is IP, there is no choice. The command is used to change between Modem-to-Modem and Modem-to-Host mode.

| | |
|------|---|
| ATB0 | Modem-to-Host mode |
| ATB1 | Modem-to-Modem mode, which is the default |
| ATB2 | Modem-to-Modem when Touch Tone dialing, Modem-to-Host when Pulse dialing. Answer in Modem-to-Modem. |
| ATB3 | Modem-to-Modem when Touch Tone dialing, Modem-to-Host when Pulse dialing. Answer in Modem-to-Host. |

Table 27: IP Modem virtual Modulation

8.5.5 AT E (echo) [ATE1]

Disable and enable the echo of the commands received. ATE0 to disable and ATE1 to enable the echo.

8.5.6 AT Q (quiet) [ATQ0]

Configures the IP Modem to remain quiet. The Modem will not send any response messages to the serial port.

8.5.7 AT V (verbose) [ATV1]

Responses as numeric values (ATV0) or as text strings (ATV1).

| | | | |
|-------------|---|--------------|---|
| OK | 0 | CONNECT | 1 |
| RING | 2 | NO CARRIER | 3 |
| ERROR | 4 | CONNECT 1200 | 5 |
| NO DIALTONE | 6 | BUSY | 7 |
| NO ANSWER | 8 | | |

Table 28: IP Modem Responses

8.5.8 AT H (hangup) [ATH0]

Command to disconnect. Also used as ATH0. The related version ATH1 to just go off-hook is not supported, and reports an ERROR.

8.5.9 AT I(n) (information) [ATI0]

Report technical information about the IP Modem. It is frequently used to identify the device. The answer is always sent as

```
<cr><lf><#response#><cr><lf><cr><lf>OK<cr><lf>
```

Here are the defined #response#-strings.

| | | |
|----------------|---|---------------------------|
| ATI or ATI0 | 230 | 230.4kbps maximum |
| ATI1 | 100000000 | 100Mbps Ethernet |
| ATI2 | | |
| ATI3 | Version 1.0 / <compile-date> | Version of Modem-Firmware |
| ATI4 | Current Profile | |
| ATI5 | | |
| ATI6 | NetCom 230k IP-Modem | Device Identification |
| ATI7 | | |
| ATI8 | | |
| ATI9 | (<Name>\Serial#\IP-#:port\Com-X\NetCom) | Display serial port used |
| ATI10 | | |
| ATI11 | <very extended information> | |

Table 29: IP Modem Information Responses

8.5.10 AT S (setup)

Set and read the S-registers for configuration. `ATSrr?` is a request to read the current value of S-register number `rr`, `ATSrr=nnn` stores the value `nnn` in the register `rr`. Unknown registers report ERROR. See section 8.4.2 above for possible registers and parameters.

8.5.11 AT L (loudness)

and

8.5.12 AT M (speaker)

These commands are answered with OK, but completely ignored. There is no function like speaker.

8.5.13 AT N (auto baud) [ATN0]

Automatic detection of serial speed. For hardware reasons this detection is not implemented. The command `ATN0` to disable automatic detection is accepted and answered with OK. The `ATN1` to enable automatic detection is not available, and answered with the ERROR response.

8.5.14 AT Z (reset)

Reset the configuration to a stored profile. IP Modem only supports profile 0 for simplicity. Same as `ATZ0` or as `AT&F` or `AT&F0`.

8.5.15 AT &F (factory settings) [AT&F0]

This command has historically been designed as "Reset to Factory settings", while ATZ simply meant reset. At time of invention users could change the default behavior of their Modem, so ATZ activated the stored profile.

Nowadays the ATZ is ignored by many software. Instead AT&F is used, followed by complex initialization strings. User may save profiles, which are selected by AT&F0 or AT&F1. There is no longer a documented or commonplace way to revert to Factory Defaults.

The IP Modem has such an option (clear the InitString via Telnet/web), but this is not usable to reset the configuration when the device is used as a Modem. So IP Modem will support only user profile0, and it uses AT&F9 to really reset the user profile to the Factory defaults.

8.5.16 AT &C (DCD configuration) [AT&C1]

Configure the DCD signal to the PC. As IP Modem this signal may be generated by the DTR output. A standard modem can have DCD always on, and it can have the DCD follow the external carrier signal. When set to always on by AT&C0 the DCD may have a separate source. The DTR is free to serve as a DSR to the PC. The operation of DSR is defined by AT&S, so these commands are related. AT&C1 is the default, the DTR operates as DCD to the PC (this will require a cable connecting NetCom⁺-DTR to the DCD of the PC).

This command has priority over AT&S.

8.5.17 AT &S (DSR configuration) [AT&S0]

Configure the DSR signal to the PC. As IP Modem this signal may be generated by the DTR output. A standard modem can have DSR always on, as long as the Modem has power. Or it can have the DSR signaling whether the IP Modem is in command or in data mode. When set to always on by AT&S0 (this is the default) the DSR may have a separate source. The DTR is free to serve as a DCD to the PC. The operation of DCD is defined by AT&C, so these commands are related. An AT&S1 has DSR follow the data mode.

The AT&C has priority over this command. AT&S1 can only be effective, if AT&C0 is set.

8.5.18 AT &D (DTR configuration) [AT&D2]

Understand the DTR signal of the PC. The input on the IP Modem is the DSR, which requires a proper serial cable. Usually this signal is either ignored, or serves to disconnect from the phone line. There are four options:

| | | |
|-------|---|-------------|
| AT&D0 | Ignore DTR from PC | |
| AT&D1 | Toggle DTR to enter command mode | |
| AT&D2 | Toggle DTR to disconnect and enter command mode | default |
| AT&D3 | Toggle DTR to reset the IP Modem | perform ATZ |

Table 30: IP Modem DTR Configuration

8.5.19 AT &K (handshake) [AT&K3]

or as alternative command . . .

8.5.20 AT \Q [AT\Q3]

Configure serial Flow Control. AT&K0 and AT\Q0 disable all Flow Control. The default is AT&K3 and AT\Q3 to use RTS/CTS Hardware Flow Control between PC and IP Modem. AT&K4 and AT\Q1 configure for XON/XOFF Software Flow Control between PC and IP Modem. Other Options are not supported.

8.5.21 AT &V (view profile)

Show Profiles. This will display the current profile, the stored user profile, the short dial strings and the factory profile. Parameters are accepted but ignored. AT&V is AT&V0 and is AT&V1.

8.5.22 AT &W (save profile)

Save the current configuration as user profile. AT&W is the same as AT&W0, all other parameters report an ERROR.

8.5.23 AT &Z (save destination)

This command will save a destination in Internet syntax. It is given by <host>:<port>. The <host> is either an IP Address in dotted octet notation, or an FQN in correct syntax. The <port> is a string representing a decimal number. If <port> is omitted, the target port is the local TCP Data Port as defined in the configuration of IP Modem (see [6.2.2.2.7](#) above).

9 Print Server Operation

Sometimes the Serial Device Servers are used together with serial printers. These printers are available via a network to several stations for printing. So far there have been two operation modes to achieve this. First the serial port can operate as a TCP Raw Server, and the station just sends the data to print via a TCP connection. As second option a computer running Windows could install the driver for virtual serial ports. The printer is then controlled via this Com port. In both these solutions the buffering of data occurred on the client station. Beginning with Firmware version 2.2 the NetCom⁺ Devices offer a true Print Server mode, using the Line Printer Daemon protocol as of RFC1197. Here a print server (lpd) is a station with one IP Address and a single defined port to accept commands and data for printing. Several printers may be attached to the print server. Each printer has a separate data queue for management of print jobs. The data of the jobs is saved in this queue, instead of the client as before.

9.1 Printer Queue

The basic function of an lpd is to accept the data for printing, store it in a spooler queue, and send it to the printer when this is ready for printing. This is done for several queues in parallel. Each printer is identified by the name of the queue, where it is attached to. The NetCom⁺ Device Servers allow to configure a custom name for each queue, while the default name is »lpd« plus the number of the serial port (lpd1, lpd2, ...). This name is set in the properties of the serial port. When the lpd is running on a separate computer, the hard disk is used to save the data of the queues. The NetCom⁺ Servers neither have a mass storage device, nor huge amounts of memory. Each queue accepts at least one job with a size of up to 250 KB print data. If the job has more data, memory is either assigned dynamically to save the job, or the data is spooled through a ring buffer. Data is printed while the client still sends data. The amount of available dynamic memory depends on the number of ports in a NetCom⁺ Device Server, and the operations active on these ports.

9.2 Printer Reset

Before a new job is sent to the printer, this printer should be in a well known state. On a parallel printer port this is easy to achieve. There is a defined signal to send a »reset« command to the printer.

Such a definition is not available for serial printers. Instead there is a reset command, which users may send via the serial line. Typically this command is specific to the manufacturer or even to the printer model. So the NetCom⁺ allows to specify this command by entering an 'InitString' for each queue.

9.2.1 Init String Definition

The Initialization of the printer typically involves ASCII control codes, ordinary ASCII characters and some binary data. On some models it may also be necessary to provide a certain state of the modem control signals RTS and DTR, applied with special timing. The 'InitString' in the NetCom⁺ Device Servers offer all these options.

9.2.1.1 ASCII Text Ordinary ASCII characters are entered as they are on the keyboard. The single exception is the 'Less Than' character '<', which is used for other special functions.

9.2.1.2 ASCII Control Codes ASCII control codes are entered by their standard name, enclosed in 'Angle Brackets', i.e. in '<' and '>' (Greater Than). Some examples of this are <ESC>, <CR> or <TAB>.

9.2.1.3 Numeric Codes Especially binary data must be sent by means of its numeric value. Since the '<' ASCII character has a special function, the only way to use this is the numeric method. This also applies to printable characters of some Extended ASCII character sets.

The NetCom⁺ accept the decimal value, also enclosed in angle brackets. Up to three decimal digits define the character to send to the printer. The '<' is used as <60>, while the <ESC> may also sent as <027>. The '>' may be used directly, however for clarity <62> should be preferred.

9.2.1.4 Modem Control Signals Via the 'InitString' control of RTS and DTR is available. This manual does not make statements about voltage levels on the signals, these are just set to an active or inactive state. <RTS+> and <RTS-> activate and deactivate the RTS signal, while <DTR+> and <DTR-> do the same for DTR.

9.2.1.5 Timing Options Especially when using Modem Control signals it will be required to hold them in a given state for a defined amount of time. This may be done by applying a »Pause«-command in the 'InitString'. The delay is given as numeric value in milliseconds (msec), preceded by a 'P'. So <P50> causes the NetCom⁺ to wait 50 msec before proceeding with the next command or start printing. Up to three digits are possible. If more than 999 msec are required, the Pause-command must be repeated.

Please note: The delay is not executed as an exact time. NetCom⁺ guarantees to wait at least the required amount of time. The smallest delay possible is 10 msec, due to internal handling of date and time.

9.2.2 Reset Example

For example here is a hypothetical serial printer. The serial port operates at 1200 bps, 7 bit and even parity and 1 stop bit. For Reset the printer requires the command "<ESC>@0" sent with DTR and RTS off. When the data is transmitted, DTR must be on, and 50 msec later RTS must also be on.

Each character sent is 10 bits long, including the start bit. At 1200 bps each character needs 8.3 msec for transmission. So the transmission lasts for 25 msec. To be sure the control signals are inactive, an extra delay is applied after change of signals. The resulting string would be <RTS-><DTR-><P10><ESC>@0<P35><DTR+><P50><RTS+> The delay of 35 msec after the command string "<ESC>@0" shall ensure, all data is completely transmitted to the printer.

9.3 Operation in Windows®

The Printer Server mode may be used to support serial printers in Windows® Operating System. This is a short instruction how to install and use it. Experience on installing printers in Windows is required for this instruction. First the installation of a new printer is given, the modification of an existing printer setup is described later.

9.3.1 Add a New Printer

From »Control Panel« open the »Printers and Faxes« windows. Select the »Add a printer« option. The usual »Add Printer« Wizard appears. Click the "Next" button to select the port, where the printer is attached to.

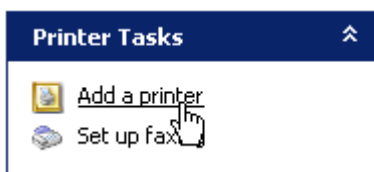

Figure 101: Add a printer

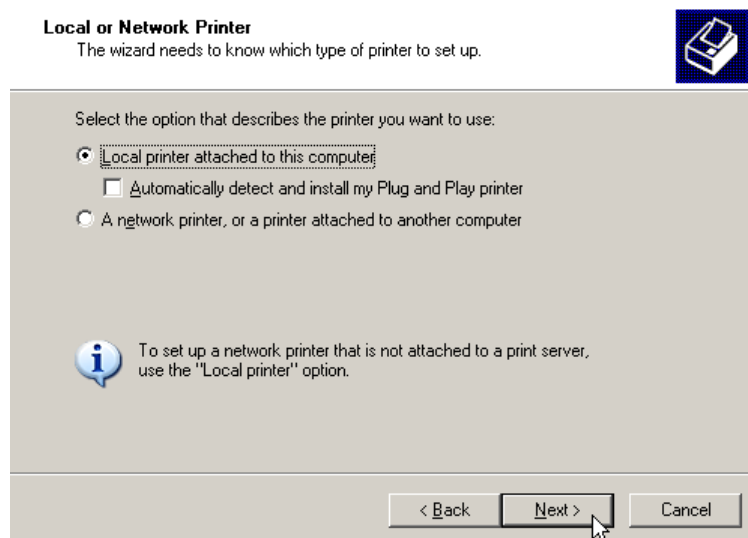

Figure 102: Select Printer Port

Select the option of »Local Printer ...«, but de-select the automatic detection of the printer type as shown below.

Click the "Next" button to continue.

9.3.1.1 Create new printer port You need to create a new port for the printer, the required type is a »Standard TCP/IP Port«.

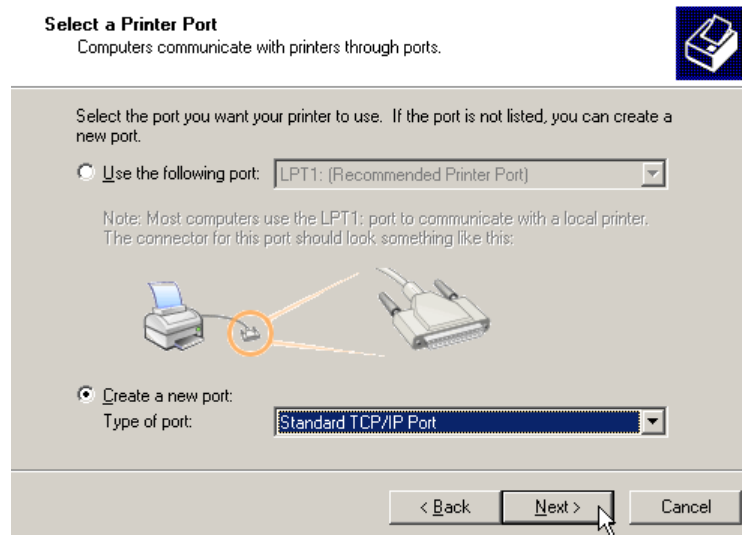

Figure 103: Create Printer Port

In the »Add Standard TCP/IP Port« Wizard just click the "Next" button, and have the NetCom⁺ Serial Device Server properly configured for LPD-operation.

9.3.1.2 Name the new Printer Port Then the properties of the new printer port must be entered.

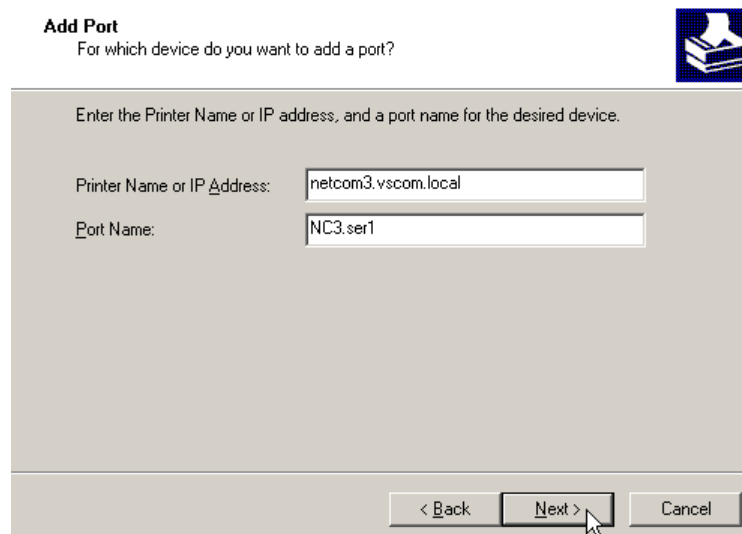

Figure 104: Name-Properties of Print Server Port

You need the network address of the NetCom⁺, this may be the IP Address or a DNS name for the device. The port name is only for internal identification in Windows. It will be listed in the possible ports to connect printers to. The name is similar to »LPT1:« or »Com3:«, but it does not denote any real hardware in your computer. You are free to enter any name not used so far. The name is not related to the LPD Queue name on the NetCom⁺. Again click the "Next" button.

9.3.1.3 Configure the Printer Port As the last step in creating the printer port for your printer you need to enter some additional information. As the »Device Type« select "Custom", and open the "Settings ...".

The screenshot shows a 'Port Settings' dialog box with the following fields and options:

- Port Name:** lpd1
- Printer Name or IP Address:** netcom3.vscom.local
- Protocol:** Raw LPR
- Raw Settings:**
 - Port Number:** 9100
- LPR Settings:**
 - Queue Name:** lpd1
 - LPR Byte Counting Enabled
 - SNMP Status Enabled
- Community Name:** public
- SNMP Device Index:** 1
- Buttons:** OK, Cancel

Figure 105: Mode-Properties of Print Server Port

Under »Port Settings« select the "LPR" protocol instead of the "Raw" method. The Port Number becomes unavailable, because the standard TCP Port 515 is used in this configuration. Enter the Queue name you configured in the NetCom⁺. Each serial port on a NetCom⁺ has a separate Queue name to identify it. So it may be a good idea to name the queue after the printer attached to the serial port. Be sure to enable the "Byte Counting", because this is required by the Print Server function in the NetCom⁺. Close these options with the "OK" button.

9.3.1.4 Install Printer Driver Now the printer port is installed, and the Printer installation Wizard continues. Select the printer from the list, or install a new type using an installation disk the usual way.

9.3.2 Modify an Existing Printer

In several situations it is necessary to modify the configuration of a printer, which is already installed in Windows. For example, the mode of use shall be changed to Printer Server Mode, the printer is moved from a local serial port to a NetCom⁺ Serial Device Server, or the installation program of the printer only accepts local serial ports to attach the printer to. In such situations it is required to create a new lpd port, and modify the configuration of the printer.

9.3.2.1 Open the properties Again open »Printers and Faxes« in the Control Panel.

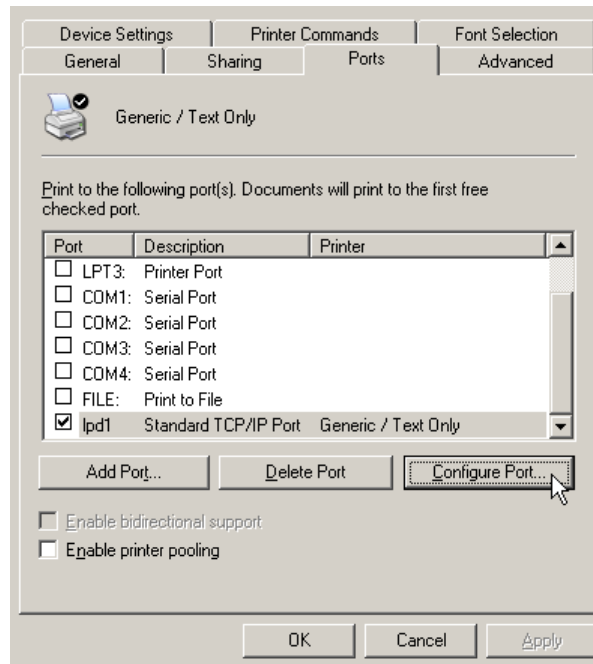

Figure 106: Select Port for Printer

Select the installed printer, and open the properties. In the properties select the tab for »Ports«.

9.3.2.2 Add the Print Server Port The button for "Add Port..." opens a dialog with the possible printer port types.

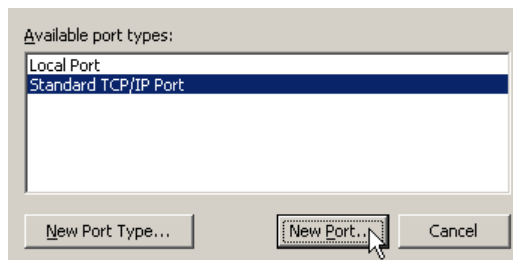

Figure 107: Add Printer Port

Select "Standard TCP/IP Port" and click on "New Port...". This will open the Add TCP Port wizard as of section 9.3.1.1 above. Proceed as described there.

10 OpenVPN™ Encryption

The NetCom Plus Serial Device Servers offer a special method of encrypted communication. Instead of modifying driver and application programs to support encryption (e.g. by using SSL), the NetCom Plus Servers provide a virtual direct network connection between the computer and the NetCom Plus. The function is similar to a cross-over Ethernet cable between the computer and the NetCom Plus. Such a technique is referred to as a "Virtual Private Network" or VPN for short. Encryption on this communication layer is totally different from WLAN Encryption like WEP or WPA, and it is independent of this option.

Applications installed on the computer just see an added network connection, if they really care about network configuration. They do not need to, the system sends and receives all data for and from the NetCom Plus on this new link. Since this link is encrypted, no application cares about it. Even a simple Telnet session becomes secure this way.

To establish the encrypted VPN link the NetCom Plus Servers use an Open Source product named OpenVPN™ (<http://openvpn.net>). OpenVPN™ is licensed under GPL, hence there is no added costs for using it. Currently OpenVPN™ is available for a wide range of systems, including Linux, Windows 2000 and above, as well as Mac OS X.

OpenVPN™ is a product full of features.

This section in the Manual will give information for the installation, and the use together with NetCom Plus Servers.

10.1 OpenVPN™ Installation

As the first step for encrypted communication the system needs the client software for OpenVPN™. This is a quite usual Application Wizard. You have to Accept a License Agreement, which is based on the GPL.



Figure 108: OpenVPN Installation Wizard

In the next step you have the option to select required components. All components are pre-selected. You may safely uncheck the »OpenVPN Source Code«.

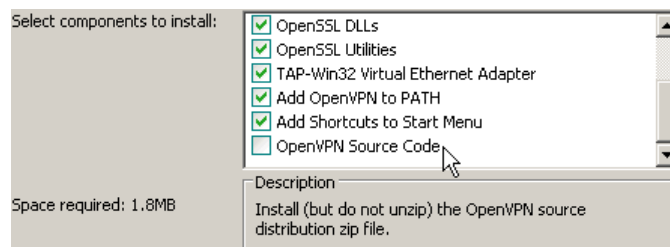

Figure 109: OpenVPN Installable Components

Proceed the installation by choosing a path for the program and related files. »OpenVPN« in your program files folder is suggested as with any other program, just accept it and continue. The Installation Wizard shows a protocol of its activities.

While installing all components, the Installation Wizard has to install a new driver for a virtual network card. Since Windows XP drivers are not only digitally signed, the system also requests either a valid signature or explicit confirmation of installation by the administrator. This time it is about the »TAP-Win32 Adapter« for OpenVPN™.



Figure 110: Installing TAP-Win32 Adapter

Just continue with the installation of OpenVPN. As the result of this installation there is a new entry in your Network Connections folder.

Installed is also a bunch of files and programs in your program files folder, and a new service for OpenVPN™. This service is configured to start "Manually", and is covered in a later section.



Figure 111: OpenVPN Network Adapter

10.2 NetCom OpenVPN Configuration

The next task is to configure the NetCom Plus for encrypted communication. It is assumed the NetCom Plus is already configured for the local (physical) network. At this step it does not matter if the communication is via Ethernet (Cable) or via WLAN antenna (Wireless), as is mentioned above. Open your web browser, and go to the address of the NetCom Plus Server. Select the 'Tools' page, and activate the option of 'DebugLog' (section 6.2.3.7 above). This is not required for operation, but will help to see what happens on the NetCom Plus.

Next go to the 'Server Configuration' page, and scroll to the section of OpenVPN (section 6.2.1.4 above). When you've setup the OpenVPN™ Configuration from the next chapter, you will upload all the needed configuration files in one ZIP package to the NetCom Plus.

You could further enable the Logging for NetCom Plus's OpenVPN function. Save all changes to the NetCom Plus.

10.3 OpenVPN™ Configuration

OpenVPN may be started in several ways. One option is the command line, which has the most flexibility. A service for OpenVPN is also installed, it will open the connection without user intervention. The next option is to use the Context-Menu of the configuration file, and finally the Graphical User Interface (GUI) installed with many modern software packages for OpenVPN. If correctly installed the GUI is the most convenient option from a users viewpoint.

All details about that are given in the documentation on <http://openvpn.net>.

10.3.1 Create OpenVPN™ Configuration

All installed connections by OpenVPN™ are defined and enabled by use of a configuration file. In principle they may also be configured by the command line directly, but a file is simpler to handle. So this manual only deals with such a configuration file. The NetCom Plus can handle any OpenVPN™ specific configuration, so we will supply one client and one server example below. For your computer side, you have to use the opposite configuration and change the directories where the files reside. If they are in the same directory as the configuration file, you can remove the path completely. Note there is a subdirectory named “/data/” in the examples.

```
# OpenVPN Client Configuration
tls-client
client
dev tun
proto tcp
# where to connect to (OpenVPN server)
remote vpn.example.com 1194
ca /data/ca.crt
cert /data/client1.crt
key /data/client1.key
cipher AES-256-CBC
comp-lzo
verb 3
# only when password used for the key
askpass /data/pass.txt
```

Figure 112: OpenVPN Client Configuration File

Normally you would be asked for the key password when you connect to the OpenVPN™ server. As this is impossible with the NetCom Plus, you had to specify the password in a single line text-file which is referred to over the `askpass` configuration value.

The configuration file must be named `config.ovpn` and put together with all other files (preserving the `/data/` directory if used) into a standard ZIP file, which must be uploaded over the web-frontend. This is an example content of a ZIP file:

- `config.ovpn`
- `ca.crt`
- `client1.crt`
- `client1.key`

Below you will see an example for the server side configuration.

```
# OpenVPN Server Configuration
tls-server
dev tun
proto tcp
# port where to listen on the server
port 1194
# the client subnet for the VPN. The server will use the 10.8.0.1 for itself
# and submit others from the range to the connected clients.
server 10.8.0.0 255.255.255.0
ca /data/ca.crt
cert /data/server.crt
key /data/server.key
dh /data/dh1024.pem
cipher AES-256-CBC
keepalive 10 120
comp-lzo
verb 3
# only when password used for the key
askpass /data/pass.txt
```

Figure 113: OpenVPN Server Configuration File

For further parameter description and examples, you must take a look at the very good documented site of OpenVPN™ - <http://openvpn.net>.

10.3.2 Create OpenVPN™ Certificate and Keys

Here is an example of how you could create certificates for the OpenVPN™ Configuration. To perform this you have to execute the following steps:

1. Open a command console and go to the `easy-rsa` sub-directory of your OpenVPN™ installation path (eg. `cd c:\Program Files\OpenVPN\easy-rsa`).
2. Call the command `init-config` which will copy the needed configuration files into place.
3. Now edit the `vars.bat` file and change all the `KEY_*` variables in the last section to your own values (eg. `KEY_COUNTRY=US`).

4. Call the commands `vars.bat`, `clean-all` and `build-ca` in this order. You could press enter for all the values for which you will be asked, except the **Common Name**, which should be the name of your VPN (eg. `MyVPN`).
5. The next command `build-key-server server` will generate a certificate and private key for the server. As before, you could leave the values on the defaults but should enter the **Common Name** (eg. `MyServer`). The password field could be blank or set for enhanced security. The last two questions must be answered with Yes ('y').
6. Now you can create as many keys as you want for your clients with `build-key client1`, `build-key client2`, ... Enter the client name from the command line for **Common Name** (eg. `client1`). The other values are the same as with the step before.
7. Finally call `build-dh` to generate Diffie-Hellman parameters for the OpenVPN™ server.
8. Now you find the certificates and keys in the subdirectory `keys`. You will use these files to create a config ZIP container for the NetCom Plus as described before or use them on your computer and copy these files with the config file (eg. `client1.ovpn`) into the config directory of OpenVPN™.

10.3.3 Start NetCom Plus with OpenVPN™ active

This is the moment to open the web browser again, and access the Server Configuration of the NetCom Plus. Go to the OpenVPN Parameter section (figure 67), and carefully double check all values. They must match the example used here. If you are sure, change the first parameter 'OpenVPN' from "Disabled" to "Server". Save the changes, and let the NetCom Plus perform its Reboot. After some time your web browser will attempt to open the Server Configuration page again, but this will fail. This is desired, because now the communication must be done encrypted. The NetCom Plus is still sending answers to PING on the Ethernet (or WLAN), and it will also accept a TCP connection for Debugging on Port 1200. Try it by opening a Telnet session to Port 1200. And finally the NetCom Plus waits for a TCP connection on Port 1194, to establish a link via OpenVPN

10.3.4 Start OpenVPN™ by Context-Menu

The Graphical User Interface (GUI) is pretty much intuitive, so it is not covered in this manual. Instead the other graphical option is documented now.

The Installation Wizard of OpenVPN™ associated the ".ovpn" file type with Notepad to open by double click. It also added an action available via the Context-Menu of the file.

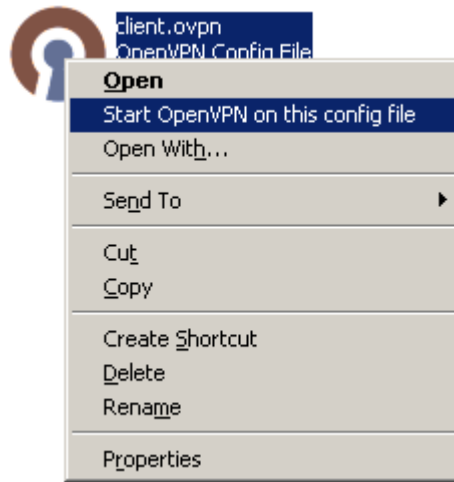

Figure 114: Context-Menu of OpenVPN™

The Context-Menu is available via right click on the file. Select the action "Start OpenVPN" to open the connection to the NetCom Plus. This will start the `openvpn.exe` program in the "bin"-subfolder of OpenVPN. There will be a console window with a lot of text output, after some seconds it will end in the text:

Initialization Sequence Completed

At this stage the network connection becomes active and usable. Windows will show this with an icon in the System Tray: The speed of "10.0 Mbps" is a virtual speed. The achievable results depend on many parameters. These include the real network speed, the network load, and the number of connected clients.

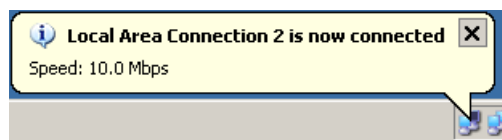

Figure 115: OpenVPN Connection is active

Open your web browser, and enter the IP Address 10.8.0.1 as the target address. The NetCom Plus will answer, and sends the welcome page. Now you have encrypted communication with the NetCom Plus.

Anyone else sniffing on the network (LAN, WLAN, Intra- or Internet) will just see data which appears like garbage. It is required to have the encryption key to get readable information.

The virtual network connection is active as long as the console window with the `openvpn.exe` program is open. Just close the windows, and the connection is closed also.

10.3.5 Start OpenVPN™ by Command line

The most simple way to activate the OpenVPN connection by command line is to use the already prepared configuration file. Open a console window, and change to the "config"-subfolder of OpenVPN. In this folder issue the command to start OpenVPN.

```
CD "Program files\OpenVPN\config"
..\bin\openvpn --config "client.ovpn"
```

Figure 116: OpenVPN by Command line

There will be a lot of text output, after some seconds it will read as:

Initialization Sequence Completed

At this stage the network connection becomes active and usable. Use TELNET or PING to test the connection from a second console window. The encrypted link is closed by Ctrl-Break on the keyboard, or by closing the console window of the openvpn.exe program.

Instead of using the Context-Menu to start the connection, it may be preferred to create a link to do the job. The command of this must be

```
"C:\Program files\OpenVPN\bin\openvpn.exe" --config client.ovpn
```

and the working directory is "C:\Program files\OpenVPN\config". This link may be placed on the desktop or in the Start Menu.

10.3.6 Start OpenVPN™ as Windows Service

There are possible configurations, which require a functional connection to the NetCom Plus Server without a user logged in. The driver for Virtual Ports is already loaded, however it does not immediately contact the NetCom Plus Server. This is done when the serial port is opened. Without OpenVPN active there is no network link to the NetCom Plus, so the serial port can not be opened.

Since Windows NT there is a method to start applications when the system is ready to have a user logon. Applications created for this task are called services. When such a Service application needs the serial ports of the NetCom Plus, the network link to the NetCom Plus must be functional. In the case of encrypted communication, this requires the openvpn.exe program already started.

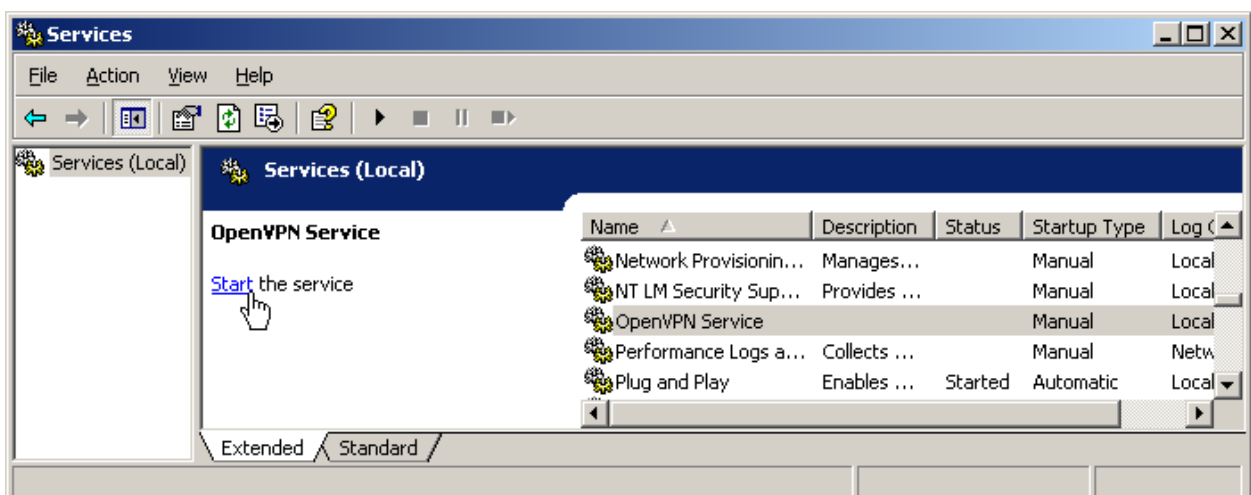

Figure 117: OpenVPN as Windows Service

The Installation Wizard also installed a Windows Service for OpenVPN in the Services applet of the Control Panel. The Startup Type is defined as "Manual", so it does not start without special user interaction or required by a dedicated application.

When the `openvpn.exe` program is started by means of this service, it scans the "config"-subfolder for configuration files of type ".ovpn". Each file causes OpenVPN to establish a connection, at least it attempts to do so. If the NetCom Plus is not available at that moment, OpenVPN will try again and again. When the NetCom Plus becomes available, the connection is established.

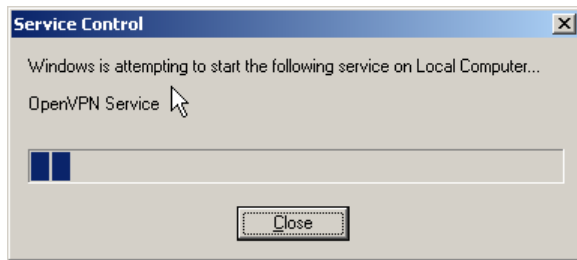

Figure 118: Start OpenVPN Service

For the first test start the Service manually by click on the "Start" link. Windows displays the progress. The connection of OpenVPN will be opened. Verify this by web browser or PING. When a service is started, Windows offers the option to "Stop" or to "Restart" it. Stopping the OpenVPN service will close all connections, Restarting will shortly drop and then re-establish them.

As each other service, also the OpenVPN service has three different types for Startup. When it is Disabled the service can't be started at all. Configured for Manual it requires explicit action to run the software. If the service is configured for Automatic start, the program is run when all drivers are finally loaded, and a user may log on to the system. But note, no user actually needs to log on to start the program. It is started independent from Startup options configured for any user.



Figure 120: Startup Types

When the configuration file "client.ovpn" is in its final state, it may be convenient to set the OpenVPN service to Automatic Startup Type. Even when the Virtual Serial Ports are only used by a dedicated user when he is logged on, nobody needs to care about enabling the network link. It will be simply available.

10.4 OpenVPN™ without Encryption

The implementation of OpenVPN™ in the NetCom Plus Serial Device Servers also offers to use the VPN tunnel without encryption. Why should one use a VPN tunnel for encryption, but actually transmit plaintext data? This option provides for a very simple setup to communicate through a complex network of Firewall implementations. As described in section Firewall Traversal Configuration, there are many parameters to provide for passing a Firewall Router, especially when this uses NAT for protection. If there is more than a single Router, this can be a lot of work. Now with OpenVPN™ only one single TCP connection must pass through the Router.

The configuration is much more simple, the Router does not need to have a lot of detailed data. All the different connections required between the Client computer and the NetCom Plus to use the Serial Device Server are carried via this single OpenVPN™ connection in TCP mode. When OpenVPN™ is used this way, probably there is no need for an extra protection by encryption. An encryption of “None” obviously saves computation resources (i.e. performance) on the NetCom Plus and on the Client computer.

10.5 Reconfigure Virtual Serial Ports for OpenVPN™

It may often happen the NetCom Plus is already installed and tested. In this process typically the drivers for Virtual Com Ports are also installed, configured and tested. Now the situation may occur where encryption is a demand. The change of installation is a rather simple process.

First install and test the encrypted connection via OpenVPN™, as described above. Now the Virtual Com Ports are no longer accessible, because this function is blocked on the IP Address used on the standard network connection (Ethernet/WLAN). It is only available on the IP Address provided by OpenVPN™ protocol.

To the driver installation this is the same situation as if the normal IP Address has changed. The configuration requires a change as documented in section [4.4.5.1](#) about changed IP Address. Proceed as described there, and then use the Virtual Com Ports via the encrypted link.

11 viaVPN Remote Access System

The paragraph [6.2.1.5 on page 72](#) mentions the option of viaVPN. Since this is only available in some models of NetCom Plus, the description of this system is delegated to this chapter entirely.

11.1 Obstacles when used via Internet

When a NetCom Plus is used via the Internet, it requires a public IP Address or at least some configuration of the Firewall at the location of the NetCom⁺. Both options allow Access from any PC to the NetCom⁺, but in some networks this is not possible for various reasons. Examples for this often include mobile communication networks by 3G or 4G functions.

Assuming such configuration is not possible, then the NetCom Plus must somehow connect to the PC, operating as a client. That would restrict the function to TCP Raw Client or UDP Mode. And this way of operation also requires similar network configuration, now at the location of the Target PC. Even more only one PC can be specified as target.

To have full access to the functions of NetCom Plus - including the Driver Mode - the PC might operate as a Server for OpenVPN. If the PC provides access to it via public Internet, the NetCom⁺ may establish a connection using OpenVPN (see [chapter 10 on page 119](#)). On this protected network there is no problem to use all functions of a NetCom⁺. But this still requires network configuration at the PC location.

As a second option using OpenVPN the user PC and the NetCom Plus may connect to a private server for OpenVPN. Then there is no need to have special network configuration at the NetCom⁺ or at the PC, since typical configurations allow such an access by default. But in this case the user has to provide the private server for OpenVPN. It must be available in public Internet, this is also not very easy.

The downside of OpenVPN is the limited access, configured for security. Either you operate the NetCom Plus via the local network (LAN), or via OpenVPN. In the second way you have to use OpenVPN not only for remote access, but for local access also.

11.2 How viaVPN solves the above Issues

The viaVPN system provides the necessary tools and components to circumvent the obstacles mentioned above. It provides a server available in public Internet, both the NetCom Plus and the Client PC connect to this. Therefore it is named as “Rendezvous Server”, where both meet. The NetCom⁺ provides special configuration, which is firewall-friendly and enables the connection to the Rendezvous Server. Likewise the PC uses a Client Utility, this allows connection to the Rendezvous Server also in a convenient and firewall-friendly manner.

The customer manages all his NetCom Plus via a web-based account, i.e. via his browser.

The connection from the NetCom⁺ to the Rendezvous Server is in parallel to the normal operation on the LAN. This allows client PCs on the LAN to operate the NetCom⁺ in the same way as without the viaVPN system. And other Client PCs via the Internet can also access the NetCom⁺ without breaking the operation on the LAN. In particular, if the Client PC is a mobile device (typically a Laptop), this PC can operate the NetCom⁺ directly in the LAN, and via the Client Utility while the PC is far away (road warrior mode).

In addition to the easy handling of devices, PCs and connections, all connections to the viaVPN system use strong and modern encryption. This prevents all eavesdropping by any party. Even more important it provides strong means of authentication, which ensures only the customer decides on who has access to the NetCom Plus.

11.3 Activation of option viaVPN

Web: menu “SERVER CONFIGURATION”, section “viaVPN Parameter

viaVPN is an add-on option in the NetCom Plus Servers, it has to be activated prior to the use. This is done by upload of a special ZIP file in the Server configuration.



Figure 121: viaVPN activation

11.4 Configuration of viaVPN Parameters

Web: menu “SERVER CONFIGURATION”, section “viaVPN Parameter”.

Telnet: “ServerConfig”, option “ViaVPN”

| | |
|---------------------------|---------------|
| viaVPN Function ? | On ▾ |
| Proxy IP Address ? | 0.0.0.0 |
| Proxy TCP Port ? | 8080 |
| Proxy User ? | |
| Proxy Password ? | |
| Retype Password: | |
| DHCP Server ? | Enabled ▾ |
| IP Address ? | 10.0.10.1 |
| Netmask ? | 255.255.255.0 |
| Broadcast ? | 10.0.10.255 |
| Range Start ? | 10.0.10.100 |
| Range End ? | 10.0.10.200 |

Figure 122: viaVPN Network Parameter (web)

The configuration is described in more details in paragraph 6.2.1.5, so here the web interface section is shown for reference only.

The first parameters are to configure the access of NetCom Plus to the Internet to establish the connection to the Rendezvous Server. Special parameters are supported, access is always via https. The NetCom Plus provides a DHCP Server to assign an IP configuration to a Client PC.

11.5 Operation with viaVPN System

As indicated in section 3.6.1 on page 29 the green LED for Ready status lights when the firmware finished starting, and the NetCom Plus is ready for operation. This behavior is modified when the NetCom⁺ is enabled for the viaVPN system.

As usual the Power LED (PWR, red) blinks when the firmware is ready. At this time the NetCom⁺ starts the connection to the viaVPN system. During this process the Ready LED (RDY, green) is not just on, instead it blinks in a slow pace (symmetric On and Off). When the connection to the Rendezvous Server is established, the Ready LED is permanent On.

When a Client PC is connected via the Utility, this is also signaled by the Ready LED. This time the LED light is interrupted (short time Off, most time On).

| Power LED | Ready LED | Status |
|-----------|-----------------|----------------------------------|
| Off | | Device off, no power |
| On | Off | Firmware startup |
| On | Symmetric Blink | Start connection to viaVPN |
| On | On | Connection to viaVPN established |
| On | Interrupted | Client PC connected to device |

Table 31: Ready LED with viaVPN

12 Modbus/TCP for Digital-Input/Output

The operation of the Digital-Input and -Output signals is based on [libmodbus software](#). This is also a library which you may use in your application to communicate with the NetCom Plus. In the NetCom Plus it supports communication via Modbus/TCP protocol as a Slave device to control digital input and output signals. This section is not intended as a documentation of Modbus protocol and communication. Basic knowledge about Modbus/TCP is assumed as available, at the end are some simple examples on how to use the signals on NetCom Plus.

12.1 Specifications

The firmware implementation supports Discrete Inputs, Coils, Input Registers and Holding Registers. These are the most useful function codes.

| | Function | Decimal Code |
|-------------------|--------------------------|--------------|
| Single bit access | Read Discrete Inputs | 02 |
| | Read Coils | 01 |
| | Write Single Coil | 05 |
| | Write Multiple Coils | 15 |
| 16 bit access | Read Holding Register | 03 |
| | Read Input Register | 04 |
| | Write Single Register | 06 |
| | Write Multiple Registers | 16 |

Table 32: Function Codes Modbus/TCP for Digital-I/O

Mapping of addresses to Digital-I/O signals:

| Coil Address | Register Address | Signals | Interpretation |
|--------------|------------------|------------------|---|
| 0 .. 7 | 0 | Input 1 .. 8 | External status 0: Input open 1: Input closed |
| 8 .. 15 | | Output 1 .. 8 | External status 0: Connect <n> to Ö 1: Connect <n> to S |
| 32 .. 47 | 2 | Data Direction | 0: Input signal 1: Output signal |
| 64 .. 79 | 4 | Direction Option | 0: Changeable 1: Fixed |

Table 33: Mapping Modbus addresses to Input-/Output-signals

12.2 Examples

12.2.1 Read two input signals

Function Read Coils is native to get the status of input signals. Here we read the status of Input 2 and 3, to see if the two pins of each are connected to each other or not.

Request:

| | | |
|---------------|------|---|
| Function Code | 01 | one byte |
| Start Address | 0001 | a 16 bit value (two bytes), 01 refers to Input 2 |
| Quantity | 0002 | a 16 bit value (two bytes), two values shall be read. |

Response:

| | | |
|---------------|------|---|
| Function Code | 01 | one byte, the same as in the request |
| Byte Count | 0001 | one byte. The requested data are two bits only, they fit in one byte |
| Data Byte | 02 | one byte as an example. This least significant bit (LSB) states the Input 2 is open (zero), and Input 3 is closed (One) |

In the same way it is possible to read the status of the output signals. Normally your application would know this status, since it is likely it defined this before the request.

12.2.2 Write one output signal

This example will set the status of Output 8 to 1 (One), to make a connection between the pins labelled 8 (central) and S.

Request:

| | | |
|----------------|------|---|
| Function Code | 05 | one byte |
| Output Address | 0015 | a 16 bit value (two bytes), 07 refers to Output 8 |
| Value | FF00 | a 16 bit value (two bytes), a special value as opposite to 0000 |

Response:

| | | |
|----------------|------|---|
| Function Code | 05 | one byte |
| Output Address | 0015 | a 16 bit value (two bytes), the same as in the request. |
| Value | FF00 | a 16 bit value (two bytes) |

In this case the response looks the same as the request.

13 TCP/IP Description

TCP/IP is the protocol used on the Internet, and in local networks as well. This opens access to any device connected somewhere to the Internet. But a simple contact like plugging in a cable is not enough. The network has to be configured. Your network administrator is responsible to do that. If any question during configuration, ask him. Configuration means to set certain parameters in any device and computer.

Since IP-configuration is a frequent source of problems, a little bit of theory is provided here.

13.1 Recommended Settings

Basically every device on the LAN has a so-called IP Address. In typical small networks the IP Address is similar to 192.168.X.Y, and there is a corresponding netmask of 255.255.255.0. The X ranges from 0 to 255, while Y is from 1 to 254. The combination of X.Y must be unique in your LAN, i.e. two stations must not have the same configuration.

13.1.1 Static Configuration

All stations on the network have a fixed IP Address. In small networks this is typically of the 192.168-type. To configure NetCom⁺ for your LAN, it must have the same 192.168.X as your computer, and the same netmask. So it needs a unique Y to establish communication.

13.1.2 DHCP Configuration

Another typical configuration is the automatic configuration. This requires a dedicated server in the LAN, which serves as a so-called DHCP server. Every device can send a request, the reply is a special configuration for this device on the network. The NetCom⁺ Devices support DHCP by default, so just use or activate it.

For best operation the DHCP server itself should be configured. It may identify the NetCom⁺ Device by its MAC- or Ethernet-Address. There should be an internal database, to always provide the same IP Address to stations with a given MAC. There are free DHCP server programs available¹⁵ for Windows Operating Systems.

If the DHCP server can not be configured to provide a reserved IP Address to the NetCom⁺, it may happen the NetCom⁺ will receive a changed address after some time. This will make the driver for this NetCom⁺ inoperative. Use the NetCom Manager to adjust the configuration of the driver.

¹⁵[DHCP Server for Windows, TFTP32](#)

13.1.3 Automatic Configuration (APIPA)

A different type of automatic configuration is used by Windows. If a station is prepared for automatic settings, it will search for a DHCP server (see above). But in SOHO networks this server might not exist.

Windows detects this failure, and the computer self-assigns an IP Address. This address is from the reserved LINKLOCAL block for such purposes. The IP Address is like 169.254.N.N, where N.N is from 1.0 to 254.255; the corresponding netmask 255.255.0.0 is mandatory.

The IP Address is selected by random, and checked if already used.

The NetCom⁺ Devices do not support this method. However it is possible to assign a static IP Address to the NetCom⁺, which matches the network configuration. Try to find an unused address in your network, starting at 169.254.0.1. Check by PING and ARP, if the address is used. If not, assign it to the NetCom⁺.

This is only a workaround. The better solution is to install or configure a simple DHCP server program. Typical SOHO Internet Routers of today already have such a server. Or you may change your network to static configuration.

13.1.4 Other Configuration

If the configuration of your computer differs from these examples, strong reasons are likely. Ask your network administrator for proper parameters in this situation.

14 Dimensions

Depending on the number of serial ports the NetCom⁺ utilize either a small or a 19 Inch compatible case. One or two serial ports come in the small casing while four and eight serial ports are installed in a case of 1HU for 19 Inch racks. Here are the dimensions of the cases with specifications for mounting holes and connector positions. The NetCom⁺ with 16 serial ports are just two 8 port mounted together.

All the pictures come from construction files so please check them carefully to identify the components and dimensions you are interested in.

14.1 Small Case for 1P / 2P NetCom⁺

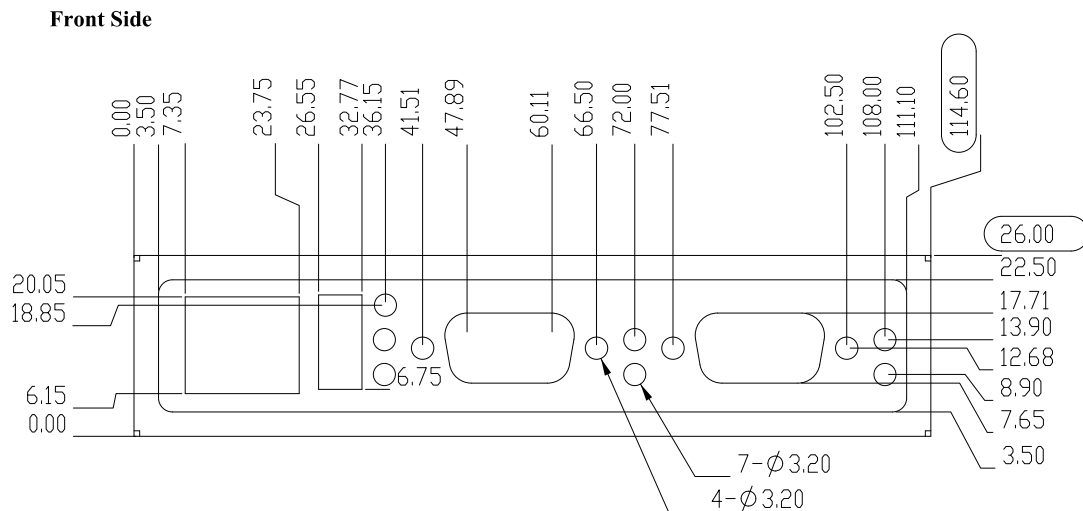

Figure 123: Front Side

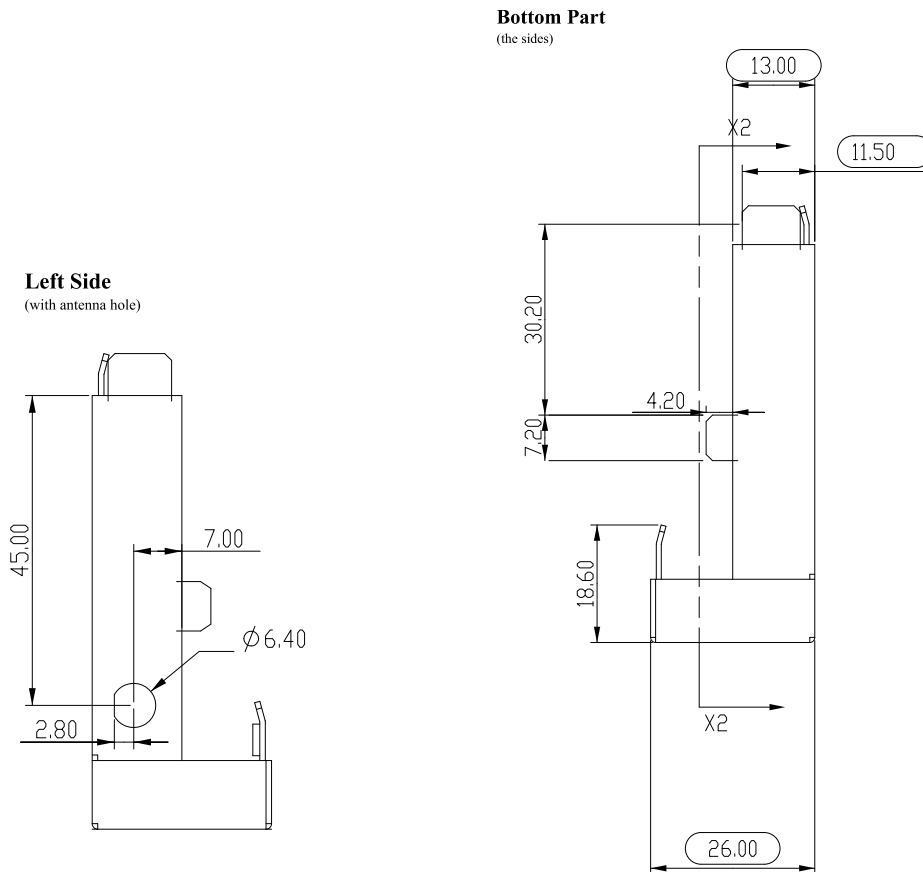

Figure 124: Left and Right Sides

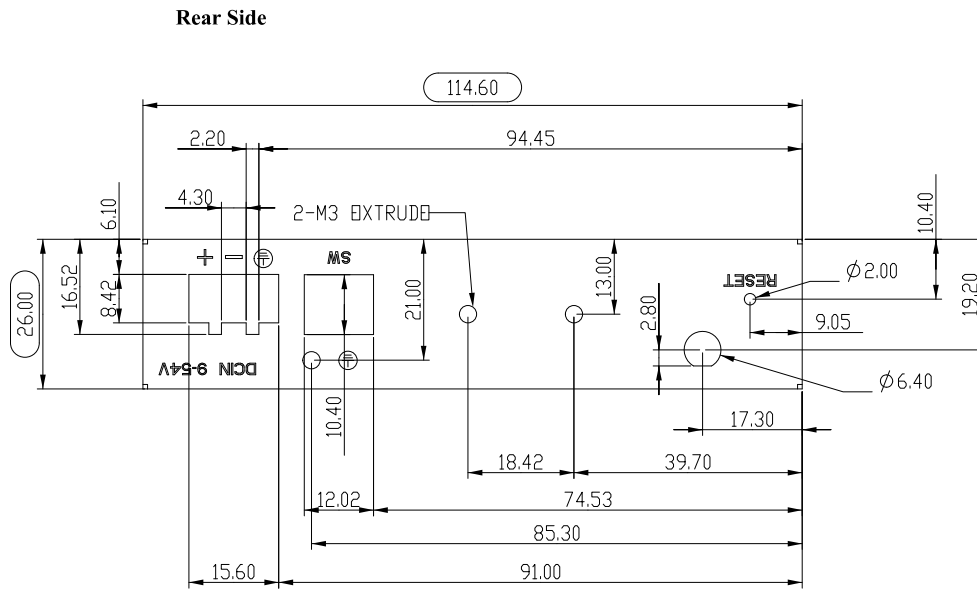

Figure 125: Rear Side

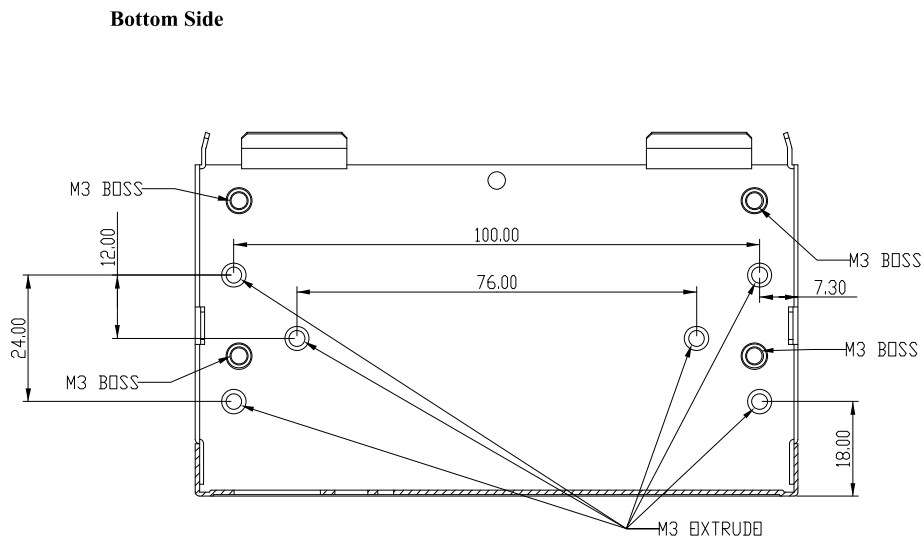

Figure 126: Bottom Side

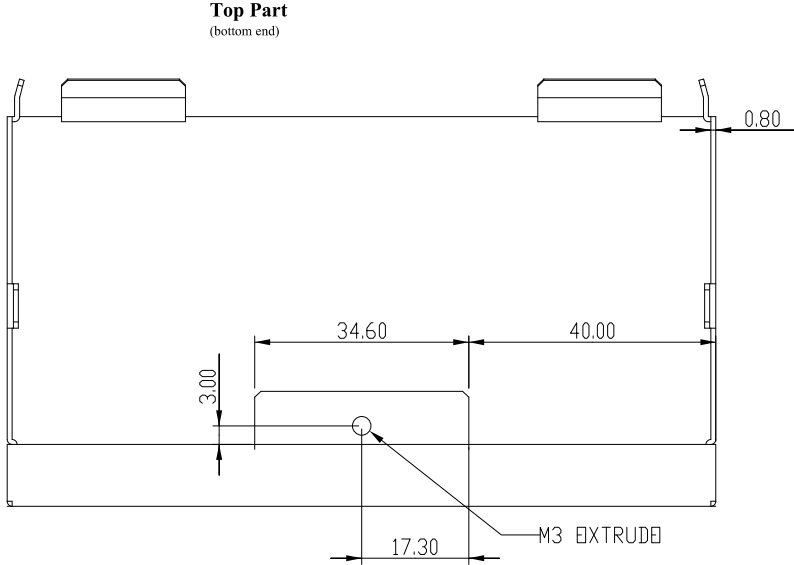
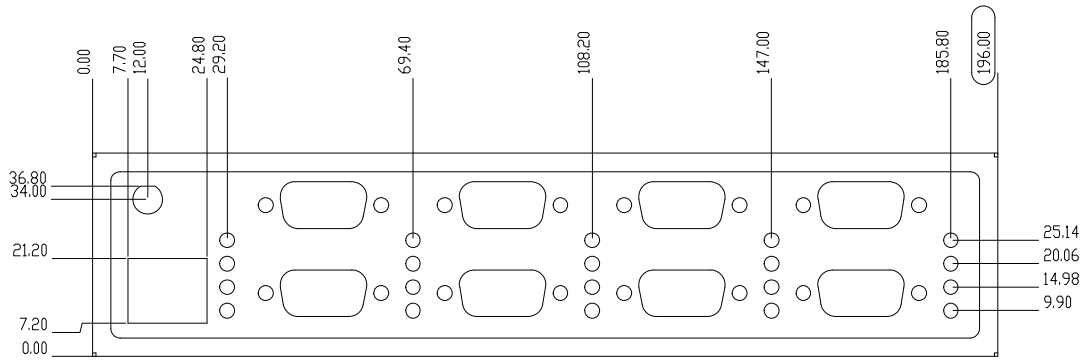

Figure 127: Top Part

14.2 19 Inch Case for 4P / 8P NetCom⁺

Front Side



Rear Side

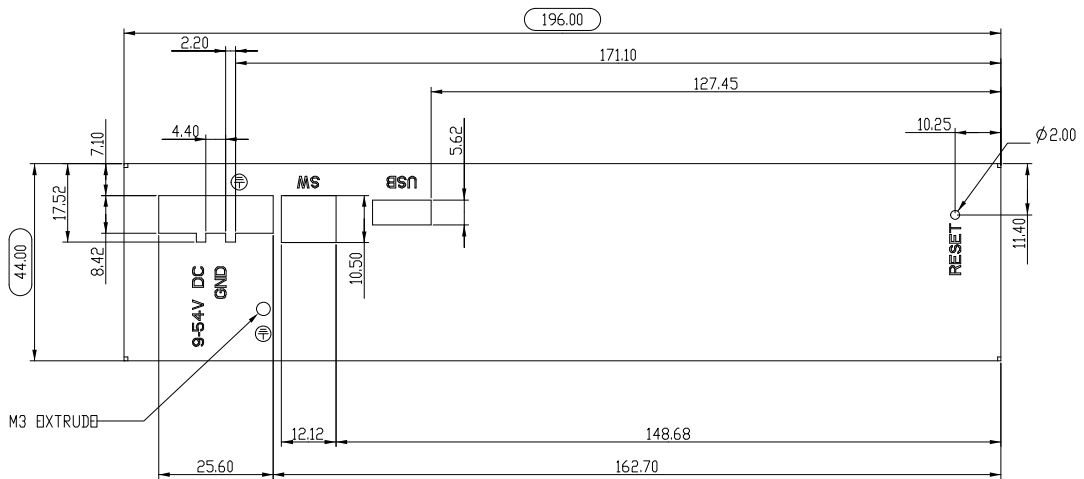

Figure 128: Front and Rear Sides

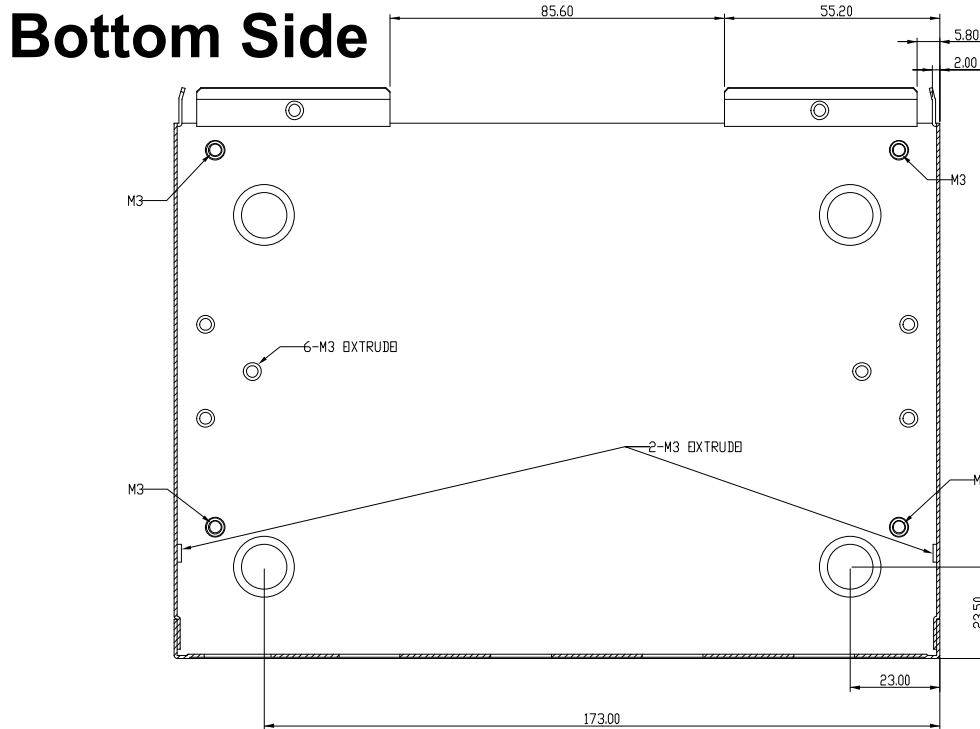

Figure 129: Bottom Side

Rackmount brackets

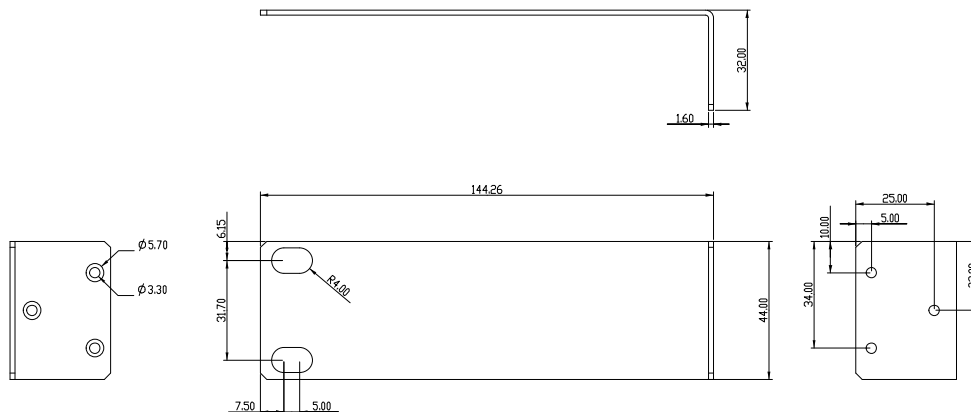

Figure 130: Rackmount (Angled) Bracket

15 Troubleshooting Guide

The most common problems when using NetCom⁺ are caused by a failure in the configuration of network parameters. This is a list of some symptoms, and tests to check them.

1. First examine the network configuration of your computer. Open a console window (MSDOS command prompt), and use the command `IPCONFIG /ALL` to retrieve the information. Among other information some data is displayed as this:

Ethernet adapter Local Area Connection:

```
Description.....: <Your LAN card>
Dhcp Enabled.....: Yes
Autoconfiguration Enabled....: Yes
IP Address.....: 192.168.1.154
Subnet Mask.....: 255.255.255.0
DHCP Server.....: 192.168.1.1
```

If DHCP is activated, and there is a DHCP server found, the configuration is OK. A common problem is an IP Address like 169.254.xxx.yyy, because this is an automated address of APIPA. If no DHCP server is present in the network, a static configuration is recommended. Here we prefer the range of 192.168.1.1 up to 192.168.1.254 for computer and NetCom⁺. Change the computers configuration, and select a similar address for NetCom⁺.

2. Start the NetCom Manager program. Search for the device, the Manager performs a discovery of available NetCom⁺ devices. Check the properties of each device for a matching serial number. Once the NetCom⁺ is identified, check the IP Address and the Netmask. If all this information is displayed as Zero, the IP settings do not match your computers settings. To correct this, you need administrative privileges for your computer. Start the NetCom Manager as Administrator, and configure correct parameters in the NetCom⁺. Close the Manager program.
3. Important: The default configuration of NetCom⁺ may result in a fixed IP Address. It will be the same for all connected devices. As a side effect the Manager can not send a dedicated configuration to a certain device. Therefore it is best to connect several NetCom⁺ one by one, configure them, connect the next and search for that device.
4. Try to PING the NetCom⁺. Open a console window and use `PING <IP-Address of NetCom+>` to send some data. The replies should reach your computer in a few milliseconds. If they time out, check the IP parameters again.
5. Telnet to the NetCom⁺. Open a console window, and use the `Telnet <IP-Address of NetCom+>` command to connect. The configuration menu appears. If not, open NetCom Manager, and check the setting of **Telnet port** in the NetCom⁺. The default is the name "telnet", or the number 23.
6. Telnet to the serial port of NetCom⁺. Open a console window, and use the `Telnet <IP-Address of NetCom+> <data port>` command to connect. Everything you type is sent out through the serial port. Every data received is displayed on the screen. To check the operation, place a standard loopback plug to the serial port. Then you see your own data as an Echo while typing.

7. Check the Device Manager for error messages.
8. Run Hyper Terminal, and open the serial port of NetCom⁺ device. Use the loopback plug to see the Echo of your typing. Use a Null Modem cable, and connect it from COM1 to the NetCom⁺. Open a second Window of Hyper Terminal for COM1. Send some data between these two windows. Transfer a file using ZMODEM protocol.
9. Often so-called Personal Firewall programs cause unspecific errors when other software starts communicating. Check the documentation of the program to see how to allow access.
10. If some special function is not operative, check for the proper version of the Firmware. In case of doubt install the latest version available (<http://www.vsc.com.de/>).
11. In rare cases or on special hardware the driver for Windows may have a problem. Please load and install the latest version (<http://www.vsc.com.de/>) and try again. It is necessary to uninstall the previous version.
12. Transmissions on IP-networks impose some extra delay in transmit and receive times. These can add to between 5 and 10 milliseconds, depending on configurations. Such delays may cause applications to complain about non-functional hardware, in fact it is a protocol/delay problem.
13. Wireless Connections may fail if the Access Point does not broadcast the SSID. The NetCom⁺ Servers need the broadcast to get the parameters from the Access Point. Hiding the SSID is not a security feature anyway.
14. Many other problems occur because of a failed serial connection, caused by wrong cabling. Here are some frequent causes.
 - a) The serial cable in RS 232 mode may simply be too long. This mostly happens with higher transmission rates.
 - b) In RS 422 and RS 485 it is mandatory to also connect the GND signal of all devices. It is a very frequent error not to do this. The information is transferred (and defined) by the positive or negative difference of the Data+ and Data- lines. However the specification requires a common voltage range between the connected devices. To ensure this range the connection of GND is required.
 - c) A network in RS 485 requires biasing resistors (polarization). The Data+ line requires a pull-up resistor to +5V, and the Data- line needs a pull-down resistor to GND. The value is about 750Ω to 1 kΩ. When no station is transmitting, the Data-lines float. This will cause noise and strange errors. The biasing resistors place a differential voltage to the lines, at least 200 mV. These resistors must not exist on the network more than once. The NetCom⁺ serial ports use circuits which do not need such biasing, therefore there is no such option. If other devices do require such function attach it to the cable directly (see section 3.3).

16 Glossary of Terms

AES: Advanced Encryption Standard

The successor of the now insecure DES. AES provides strong and modern encryption, with long keys up to 256 Bit (DES used 56 Bit).

APIPA: Automatic Private IP Addressing

A scheme to self-assign an Address to a network device. The device selects an address of the LINKLOCAL range 169.254.1.0 to 169.254.254.255 by random. If this address is unused, it assigns it to itself. Otherwise the next address is tested. It became widespread with Windows 98. The netmask is 255.255.0.0, these addresses are not routed on the Internet.

ART: Automatic Receive Transmit control

Special control for RS 485 modes. In RS 485 the line driver for transmitting must be disabled (tri-stated) when the device does not send data. In a 2-wire configuration this is known as data direction change, with 4-wire it is called line contention.

CSV: Comma Separated Values

A format to store tabular data in compact text form. Each line describes a new data set. Data fields are separated by a special character. Though the name CSV suggests a comma (','), in reality the delimiting character often is a semicolon or a <TAB> control character.

DHCP: Dynamic Host Configuration Protocol

A service used to retrieve an IP-configuration and optionally much more information from a database server.

FTP: File Transfer Protocol

A common protocol to access a file server.

HTTP: HyperText Transfer Protocol

The protocol used by web browsers to access a web server.

Internet: The net connecting networks

A set of protocols to exchange data between different networks. These information's are carried via a global network of fibers and satellite links.

IP: Internet Protocol

The basic definitions for data packages. These Internet frames are stored and transported embedded in data frames of the local network.

IP Address: Internet Address

The Internet address is noted as a group of 4 decimal numbers (IPv4). Each station on the Internet has a unique address. Some ranges are reserved for private networks, not connected to the Internet.

LINKLOCAL: Address range for private networks

This range 169.254.0.0-169.254.255.255 (Netmask of 255.255.0.0) is reserved for private networks, i.e. not connected to the Internet. Designed for small number of stations, using some automatic configuration scheme. Used with APIPA.

NAT: Network Address Translation

A technique to have a private LAN share one (few) public IP Address(es). With NAT the transport information in IP-frames is replaced by the public data of the NAT-Router.

Netmask: Groups stations to a Net

The AND-operation between the IP Address and the Mask is an important value. When to stations have the same result and the same mask, they are "in the same net". Which means they can communicate direct, without transmitting to a Router.

PAT: Port Address Translation

A technique to share a public IP Address by many internal servers on private addresses. The target address and port is replaced with values stored in an internal table. Mostly used together with NAT.

Router: Transmits data over the Internet

The backbone devices of the Internet. Routers connect two networks together. On one side they receive data frames containing IP-data. They extract these data, and send them on another side; there also stored in data frames of the second network. Typically they connect more than two networks. The basic task is to decide which route the IP-data must take now.

RS232/V.24: common serial transmission

Characters are sent as separate bits, timing is well defined. The medium is copper cable, using typical +/- 12 Volt. Each signal is defined related to a common ground; one wire per signal plus GND. RS232 is a point-to-point connection.

RS422/V.11: Industrial serial transmission (multidrop)

A transmission method with balanced signals. Designed for higher speed, longer cables and is resistive against electrical noise. RS422 allows for up to 16 receivers. The typical transmission is via twisted pair copper cable using balanced signals. Sender and receivers must share a common voltage range (max. +/-7 Volt difference). Two lines per signal, plus common GND. RS422 is a point-to-multipoint connection.

RS485: Industrial serial transmission (multipoint)

The signals and cables are the same as RS422. The transmitters can go tri-state. Several stations can send data on the same lines, at different times. RS485 is a multipoint-to-multipoint connection.

SNMP: Simple Network Management Protocol

A general purpose configuration system. Devices understanding SNMP may be configured and monitored.

TCP/IP: Transmission Control Program/Internet Protocol

TCP establishes connections between two partners via the Internet. The data is sent in IP-frames, each frame is acknowledged by the recipient. Lost packages are repeated. Software using TCP has a secured transmission; the delivery of the data is guaranteed.

TKIP: Temporal Key Integrity Protocol

An encryption scheme for Wireless LAN. It was developed from the WEP. The key used for encryption is changed while data is transmitted. An attacker will not get enough data with the same key to break the code.

UDP: User datagram protocol

Similar to TCP the data is sent in IP-frames. But in opposite there is no connection or acknowledge by the recipient. The transmission is faster for small data, but data can get lost. Software using UDP must handle the related problems.

UPnP: Universal Plug and Play

Devices announce their presence on the network, and return their capabilities. Depending on the type of device certain configuration is done, specific functions become available. Specialized software can detect those devices, and offer their services without manual configuration.

VPN: Virtual Private Network

A public network is used to transport data for a limited set of stations. Drivers on these stations generate virtual network cables between the stations. In many installations the communication through the public network is encrypted, to avoid tampering of the lines.

WEP: Wired Equivalent Privacy

An encryption scheme used with early implementations of WLAN. The idea was to make it as difficult to read other persons data, as it was with cable communications. Due to weak definitions in WEP nowadays it may cost an attacker less than a minute to get the current encryption key.

WLAN: short for Wireless LAN

This is a general name, however today this phrase is used for the IEEE 802.11-protocol definitions.

WPA: Wireless Protected Access

This is the successor of WEP. WPA not only includes better/stronger encryption, there is also a set of functions to restrict access by means of user authorization, or different hardware parameters (MAC address, distance).

WPA2: Wireless Protected Access 2

This a modified version of WPA. Most important is the implementation of AES-256 as available cypher.

17 Open Source Software Licenses

The NetCom⁺ use open source software to fulfill part of the functions. Licenses for the open source software are granted under the GNU General Public License in various versions. The license texts are put below for reference.

17.1 GPLv2

This text is a copy of the [GNU reference page](#). In case of errors or conflicts the version on the web applies.

GNU GENERAL PUBLIC LICENSE

Version 2, June 1991

Copyright © 1989, 1991 Free Software Foundation, Inc. 51 Franklin Street, Fifth Floor, Boston, MA 02110-1301, USA Everyone is permitted to copy and distribute verbatim copies of this license document, but changing it is not allowed.

Preamble

The licenses for most software are designed to take away your freedom to share and change it. By contrast, the GNU General Public License is intended to guarantee your freedom to share and change free software—to make sure the software is free for all its users. This General Public License applies to most of the Free Software Foundation’s software and to any other program whose authors commit to using it. (Some other Free Software Foundation software is covered by the GNU Library General Public License instead.) You can apply it to your programs, too. When we speak of free software, we are referring to freedom, not price. Our General Public Licenses are designed to make sure that you have the freedom to distribute copies of free software (and charge for this service if you wish), that you receive source code or can get it if you want it, that you can change the software or use pieces of it in new free programs; and that you know you can do these things. To protect your rights, we need to make restrictions that forbid anyone to deny you these rights or to ask you to surrender the rights. These restrictions translate to certain responsibilities for you if you distribute copies of the software, or if you modify it. For example, if you distribute copies of such a program, whether gratis or for a fee, you must give the recipients all the rights that you have. You must make sure that they, too, receive or can get the source code. And you must show them these terms so they know their rights. We protect your rights with two steps: (1) copyright the software, and (2) offer you this license which gives you legal permission to copy, distribute and/or modify the software. Also, for each author’s protection and ours, we want to make certain that everyone understands that there is no warranty for this free software. If the software is modified by someone else and passed on, we want its recipients to know that what they have is not the original, so that any problems introduced by others will not reflect on the original authors’ reputations. Finally, any free program is threatened constantly by software patents. We wish to avoid the danger that redistributors of a free program will individually obtain patent licenses, in

effect making the program proprietary. To prevent this, we have made it clear that any patent must be licensed for everyone's free use or not licensed at all. The precise terms and conditions for copying, distribution and modification follow.

TERMS AND CONDITIONS FOR COPYING, DISTRIBUTION AND MODIFICATION

0. This License applies to any program or other work which contains a notice placed by the copyright holder saying it may be distributed under the terms of this General Public License. The "Program", below, refers to any such program or work, and a "work based on the Program" means either the Program or any derivative work under copyright law: that is to say, a work containing the Program or a portion of it, either verbatim or with modifications and/or translated into another language. (Hereinafter, translation is included without limitation in the term "modification".) Each licensee is addressed as "you". Activities other than copying, distribution and modification are not covered by this License; they are outside its scope. The act of running the Program is not restricted, and the output from the Program is covered only if its contents constitute a work based on the Program (independent of having been made by running the Program). Whether that is true depends on what the Program does.
1. You may copy and distribute verbatim copies of the Program's source code as you receive it, in any medium, provided that you conspicuously and appropriately publish on each copy an appropriate copyright notice and disclaimer of warranty; keep intact all the notices that refer to this License and to the absence of any warranty; and give any other recipients of the Program a copy of this License along with the Program. You may charge a fee for the physical act of transferring a copy, and you may at your option offer warranty protection in exchange for a fee.
2. You may modify your copy or copies of the Program or any portion of it, thus forming a work based on the Program, and copy and distribute such modifications or work under the terms of Section 1 above, provided that you also meet all of these conditions:
 - a) You must cause the modified files to carry prominent notices stating that you changed the files and the date of any change.
 - b) You must cause any work that you distribute or publish, that in whole or in part contains or is derived from the Program or any part thereof, to be licensed as a whole at no charge to all third parties under the terms of this License.
 - c) If the modified program normally reads commands interactively when run, you must cause it, when started running for such interactive use in the most ordinary way, to print or display an announcement including an appropriate copyright notice and a notice that there is no warranty (or else, saying that you provide a warranty) and that users may redistribute the program under these conditions, and telling the user how to view a copy of this License. (Exception: if the Program itself is interactive but does not normally print such an announcement, your work based on the Program is not required to print an announcement.)

These requirements apply to the modified work as a whole. If identifiable sections of that work are not derived from the Program, and can be reasonably considered independent and separate works in themselves, then this License, and its terms, do not apply to those sections when you distribute them as separate works. But when you distribute the same sections as part of a whole which is a work based on the Program, the distribution of the whole must be on the terms of this License, whose permissions for other licensees extend to the entire

whole, and thus to each and every part regardless of who wrote it. Thus, it is not the intent of this section to claim rights or contest your rights to work written entirely by you; rather, the intent is to exercise the right to control the distribution of derivative or collective works based on the Program. In addition, mere aggregation of another work not based on the Program with the Program (or with a work based on the Program) on a volume of a storage or distribution medium does not bring the other work under the scope of this License.

3. You may copy and distribute the Program (or a work based on it, under Section 2) in object code or executable form under the terms of Sections 1 and 2 above provided that you also do one of the following:
 - a) Accompany it with the complete corresponding machine-readable source code, which must be distributed under the terms of Sections 1 and 2 above on a medium customarily used for software interchange; or,
 - b) Accompany it with a written offer, valid for at least three years, to give any third party, for a charge no more than your cost of physically performing source distribution, a complete machine-readable copy of the corresponding source code, to be distributed under the terms of Sections 1 and 2 above on a medium customarily used for software interchange; or,
 - c) Accompany it with the information you received as to the offer to distribute corresponding source code. (This alternative is allowed only for noncommercial distribution and only if you received the program in object code or executable form with such an offer, in accord with Subsection b above.)

The source code for a work means the preferred form of the work for making modifications to it. For an executable work, complete source code means all the source code for all modules it contains, plus any associated interface definition files, plus the scripts used to control compilation and installation of the executable. However, as a special exception, the source code distributed need not include anything that is normally distributed (in either source or binary form) with the major components (compiler, kernel, and so on) of the operating system on which the executable runs, unless that component itself accompanies the executable. If distribution of executable or object code is made by offering access to copy from a designated place, then offering equivalent access to copy the source code from the same place counts as distribution of the source code, even though third parties are not compelled to copy the source along with the object code.

4. You may not copy, modify, sublicense, or distribute the Program except as expressly provided under this License. Any attempt otherwise to copy, modify, sublicense or distribute the Program is void, and will automatically terminate your rights under this License. However, parties who have received copies, or rights, from you under this License will not have their licenses terminated so long as such parties remain in full compliance.
5. You are not required to accept this License, since you have not signed it. However, nothing else grants you permission to modify or distribute the Program or its derivative works. These actions are prohibited by law if you do not accept this License. Therefore, by modifying or distributing the Program (or any work based on the Program), you indicate your acceptance of this License to do so, and all its terms and conditions for copying, distributing or modifying the Program or works based on it.
6. Each time you redistribute the Program (or any work based on the Program), the recipient automatically receives a license from the original licensor to copy, distribute or modify the

Program subject to these terms and conditions. You may not impose any further restrictions on the recipients' exercise of the rights granted herein. You are not responsible for enforcing compliance by third parties to this License.

7. If, as a consequence of a court judgment or allegation of patent infringement or for any other reason (not limited to patent issues), conditions are imposed on you (whether by court order, agreement or otherwise) that contradict the conditions of this License, they do not excuse you from the conditions of this License. If you cannot distribute so as to satisfy simultaneously your obligations under this License and any other pertinent obligations, then as a consequence you may not distribute the Program at all. For example, if a patent license would not permit royalty-free redistribution of the Program by all those who receive copies directly or indirectly through you, then the only way you could satisfy both it and this License would be to refrain entirely from distribution of the Program. If any portion of this section is held invalid or unenforceable under any particular circumstance, the balance of the section is intended to apply and the section as a whole is intended to apply in other circumstances. It is not the purpose of this section to induce you to infringe any patents or other property right claims or to contest validity of any such claims; this section has the sole purpose of protecting the integrity of the free software distribution system, which is implemented by public license practices. Many people have made generous contributions to the wide range of software distributed through that system in reliance on consistent application of that system; it is up to the author/donor to decide if he or she is willing to distribute software through any other system and a licensee cannot impose that choice. This section is intended to make thoroughly clear what is believed to be a consequence of the rest of this License.
8. If the distribution and/or use of the Program is restricted in certain countries either by patents or by copyrighted interfaces, the original copyright holder who places the Program under this License may add an explicit geographical distribution limitation excluding those countries, so that distribution is permitted only in or among countries not thus excluded. In such case, this License incorporates the limitation as if written in the body of this License.
9. The Free Software Foundation may publish revised and/or new versions of the General Public License from time to time. Such new versions will be similar in spirit to the present version, but may differ in detail to address new problems or concerns. Each version is given a distinguishing version number. If the Program specifies a version number of this License which applies to it and "any later version", you have the option of following the terms and conditions either of that version or of any later version published by the Free Software Foundation. If the Program does not specify a version number of this License, you may choose any version ever published by the Free Software Foundation.
10. If you wish to incorporate parts of the Program into other free programs whose distribution conditions are different, write to the author to ask for permission. For software which is copyrighted by the Free Software Foundation, write to the Free Software Foundation; we sometimes make exceptions for this. Our decision will be guided by the two goals of preserving the free status of all derivatives of our free software and of promoting the sharing and reuse of software generally.

NO WARRANTY

11. BECAUSE THE PROGRAM IS LICENSED FREE OF CHARGE, THERE IS NO WARRANTY FOR THE PROGRAM, TO THE EXTENT PERMITTED BY APPLICABLE LAW. EXCEPT WHEN OTHERWISE STATED IN WRITING THE COPYRIGHT HOLDERS AND/OR OTHER PARTIES PROVIDE THE PROGRAM "AS IS" WITHOUT WARRANTY OF ANY KIND, EITHER EXPRESSED OR IMPLIED,

INCLUDING, BUT NOT LIMITED TO, THE IMPLIED WARRANTIES OF MERCHANTABILITY AND FITNESS FOR A PARTICULAR PURPOSE. THE ENTIRE RISK AS TO THE QUALITY AND PERFORMANCE OF THE PROGRAM IS WITH YOU. SHOULD THE PROGRAM PROVE DEFECTIVE, YOU ASSUME THE COST OF ALL NECESSARY SERVICING, REPAIR OR CORRECTION.

12. IN NO EVENT UNLESS REQUIRED BY APPLICABLE LAW OR AGREED TO IN WRITING WILL ANY COPYRIGHT HOLDER, OR ANY OTHER PARTY WHO MAY MODIFY AND/OR REDISTRIBUTE THE PROGRAM AS PERMITTED ABOVE, BE LIABLE TO YOU FOR DAMAGES, INCLUDING ANY GENERAL, SPECIAL, INCIDENTAL OR CONSEQUENTIAL DAMAGES ARISING OUT OF THE USE OR INABILITY TO USE THE PROGRAM (INCLUDING BUT NOT LIMITED TO LOSS OF DATA OR DATA BEING RENDERED INACCURATE OR LOSSES SUSTAINED BY YOU OR THIRD PARTIES OR A FAILURE OF THE PROGRAM TO OPERATE WITH ANY OTHER PROGRAMS), EVEN IF SUCH HOLDER OR OTHER PARTY HAS BEEN ADVISED OF THE POSSIBILITY OF SUCH DAMAGES.

END OF TERMS AND CONDITIONS

17.2 LGPLv2.1

This text is a copy of the [GNU reference page](#). In case of errors or conflicts the version on the web applies.

GNU LESSER GENERAL PUBLIC LICENSE

Version 2.1, February 1999

Copyright (C) 1991, 1999 Free Software Foundation, Inc.

51 Franklin Street, Fifth Floor, Boston, MA 02110-1301 USA

Everyone is permitted to copy and distribute verbatim copies of this license document, but changing it is not allowed.

[This is the first released version of the Lesser GPL. It also counts as the successor of the GNU Library Public License, version 2, hence the version number 2.1.]

Preamble

The licenses for most software are designed to take away your freedom to share and change it. By contrast, the GNU General Public Licenses are intended to guarantee your freedom to share and change free software—to make sure the software is free for all its users. This license, the Lesser General Public License, applies to some specially designated software packages—typically libraries—of the Free Software Foundation and other authors who decide to use it. You can use it too, but we suggest you first think carefully about whether this license or the ordinary General Public License is the better strategy to use in any particular case, based on the explanations below. When we speak of free software, we are referring to freedom of use, not price. Our General Public Licenses are designed to make sure that you have the freedom to distribute copies of free software (and charge for this service if you wish); that you receive source code or can get it if you want it; that you can change the software and use pieces of it in new free programs; and that you are informed that you

can do these things. To protect your rights, we need to make restrictions that forbid distributors to deny you these rights or to ask you to surrender these rights. These restrictions translate to certain responsibilities for you if you distribute copies of the library or if you modify it. For example, if you distribute copies of the library, whether gratis or for a fee, you must give the recipients all the rights that we gave you. You must make sure that they, too, receive or can get the source code. If you link other code with the library, you must provide complete object files to the recipients, so that they can relink them with the library after making changes to the library and recompiling it. And you must show them these terms so they know their rights. We protect your rights with a two-step method: (1) we copyright the library, and (2) we offer you this license, which gives you legal permission to copy, distribute and/or modify the library. To protect each distributor, we want to make it very clear that there is no warranty for the free library. Also, if the library is modified by someone else and passed on, the recipients should know that what they have is not the original version, so that the original author's reputation will not be affected by problems that might be introduced by others. Finally, software patents pose a constant threat to the existence of any free program. We wish to make sure that a company cannot effectively restrict the users of a free program by obtaining a restrictive license from a patent holder. Therefore, we insist that any patent license obtained for a version of the library must be consistent with the full freedom of use specified in this license. Most GNU software, including some libraries, is covered by the ordinary GNU General Public License. This license, the GNU Lesser General Public License, applies to certain designated libraries, and is quite different from the ordinary General Public License. We use this license for certain libraries in order to permit linking those libraries into non-free programs. When a program is linked with a library, whether statically or using a shared library, the combination of the two is legally speaking a combined work, a derivative of the original library. The ordinary General Public License therefore permits such linking only if the entire combination fits its criteria of freedom. The Lesser General Public License permits more lax criteria for linking other code with the library. We call this license the "Lesser" General Public License because it does Less to protect the user's freedom than the ordinary General Public License. It also provides other free software developers Less of an advantage over competing non-free programs. These disadvantages are the reason we use the ordinary General Public License for many libraries. However, the Lesser license provides advantages in certain special circumstances. For example, on rare occasions, there may be a special need to encourage the widest possible use of a certain library, so that it becomes a de-facto standard. To achieve this, non-free programs must be allowed to use the library. A more frequent case is that a free library does the same job as widely used non-free libraries. In this case, there is little to gain by limiting the free library to free software only, so we use the Lesser General Public License. In other cases, permission to use a particular library in non-free programs enables a greater number of people to use a large body of free software. For example, permission to use the GNU C Library in non-free programs enables many more people to use the whole GNU operating system, as well as its variant, the GNU/Linux operating system. Although the Lesser General Public License is Less protective of the users' freedom, it does ensure that the user of a program that is linked with the Library has the freedom and the wherewithal to run that program using a modified version of the Library. The precise terms and conditions for copying, distribution and modification follow. Pay close attention to the difference between a "work based on the library" and a "work that uses the library". The former contains code derived from the library, whereas the latter must be combined with the library in order to run.

TERMS AND CONDITIONS FOR COPYING, DISTRIBUTION AND MODIFICATION

0. This License Agreement applies to any software library or other program which contains a notice placed by the copyright holder or other authorized party saying it may be distributed under the terms of this Lesser General Public License (also called “this License”). Each licensee is addressed as “you”. A “library” means a collection of software functions and/or data prepared so as to be conveniently linked with application programs (which use some of those functions and data) to form executables. The “Library”, below, refers to any such software library or work which has been distributed under these terms. A “work based on the Library” means either the Library or any derivative work under copyright law: that is to say, a work containing the Library or a portion of it, either verbatim or with modifications and/or translated straightforwardly into another language. (Hereinafter, translation is included without limitation in the term “modification”.) “Source code” for a work means the preferred form of the work for making modifications to it. For a library, complete source code means all the source code for all modules it contains, plus any associated interface definition files, plus the scripts used to control compilation and installation of the library. Activities other than copying, distribution and modification are not covered by this License; they are outside its scope. The act of running a program using the Library is not restricted, and output from such a program is covered only if its contents constitute a work based on the Library (independent of the use of the Library in a tool for writing it). Whether that is true depends on what the Library does and what the program that uses the Library does.

1. You may copy and distribute verbatim copies of the Library’s complete source code as you receive it, in any medium, provided that you conspicuously and appropriately publish on each copy an appropriate copyright notice and disclaimer of warranty; keep intact all the notices that refer to this License and to the absence of any warranty; and distribute a copy of this License along with the Library. You may charge a fee for the physical act of transferring a copy, and you may at your option offer warranty protection in exchange for a fee. **2.** You may modify your copy or copies of the Library or any portion of it, thus forming a work based on the Library, and copy and distribute such modifications or work under the terms of Section 1 above, provided that you also meet all of these conditions:

- **a)** The modified work must itself be a software library.
- **b)** You must cause the files modified to carry prominent notices stating that you changed the files and the date of any change.
- **c)** You must cause the whole of the work to be licensed at no charge to all third parties under the terms of this License.
- **d)** If a facility in the modified Library refers to a function or a table of data to be supplied by an application program that uses the facility, other than as an argument passed when the facility is invoked, then you must make a good faith effort to ensure that, in the event an application does not supply such function or table, the facility still operates, and performs whatever part of its purpose remains meaningful. (For example, a function in a library to compute square roots has a purpose that is entirely well-defined independent of the application. Therefore, Subsection 2d requires that any application-supplied function or table used by this function must be optional: if the application does not supply it, the square root function must still compute square roots.)

These requirements apply to the modified work as a whole. If identifiable sections of that work are not derived from the Library, and can be reasonably considered independent and separate works in themselves, then this License, and its terms, do not apply to those sections when you distribute them as separate works. But when you distribute the same sections as part of a whole which is a work based on the Library, the distribution of the whole must be on the terms of this License, whose permissions for other licensees extend to the entire whole, and thus to each and every part

regardless of who wrote it. Thus, it is not the intent of this section to claim rights or contest your rights to work written entirely by you; rather, the intent is to exercise the right to control the distribution of derivative or collective works based on the Library. In addition, mere aggregation of another work not based on the Library with the Library (or with a work based on the Library) on a volume of a storage or distribution medium does not bring the other work under the scope of this License.

3. You may opt to apply the terms of the ordinary GNU General Public License instead of this License to a given copy of the Library. To do this, you must alter all the notices that refer to this License, so that they refer to the ordinary GNU General Public License, version 2, instead of to this License. (If a newer version than version 2 of the ordinary GNU General Public License has appeared, then you can specify that version instead if you wish.) Do not make any other change in these notices. Once this change is made in a given copy, it is irreversible for that copy, so the ordinary GNU General Public License applies to all subsequent copies and derivative works made from that copy. This option is useful when you wish to copy part of the code of the Library into a program that is not a library.

4. You may copy and distribute the Library (or a portion or derivative of it, under Section 2) in object code or executable form under the terms of Sections 1 and 2 above provided that you accompany it with the complete corresponding machine-readable source code, which must be distributed under the terms of Sections 1 and 2 above on a medium customarily used for software interchange. If distribution of object code is made by offering access to copy from a designated place, then offering equivalent access to copy the source code from the same place satisfies the requirement to distribute the source code, even though third parties are not compelled to copy the source along with the object code.

5. A program that contains no derivative of any portion of the Library, but is designed to work with the Library by being compiled or linked with it, is called a “work that uses the Library”. Such a work, in isolation, is not a derivative work of the Library, and therefore falls outside the scope of this License. However, linking a “work that uses the Library” with the Library creates an executable that is a derivative of the Library (because it contains portions of the Library), rather than a “work that uses the library”. The executable is therefore covered by this License. Section 6 states terms for distribution of such executables. When a “work that uses the Library” uses material from a header file that is part of the Library, the object code for the work may be a derivative work of the Library even though the source code is not. Whether this is true is especially significant if the work can be linked without the Library, or if the work is itself a library. The threshold for this to be true is not precisely defined by law. If such an object file uses only numerical parameters, data structure layouts and accessors, and small macros and small inline functions (ten lines or less in length), then the use of the object file is unrestricted, regardless of whether it is legally a derivative work. (Executables containing this object code plus portions of the Library will still fall under Section 6.) Otherwise, if the work is a derivative of the Library, you may distribute the object code for the work under the terms of Section 6. Any executables containing that work also fall under Section 6, whether or not they are linked directly with the Library itself.

6. As an exception to the Sections above, you may also combine or link a “work that uses the Library” with the Library to produce a work containing portions of the Library, and distribute that work under terms of your choice, provided that the terms permit modification of the work for the customer’s own use and reverse engineering for debugging such modifications. You must give prominent notice with each copy of the work that the Library is used in it and that the Library and its use are covered by this License. You must supply a copy of this License. If the work during execution displays copyright notices, you must include the copyright notice for the Library among them, as well as a reference directing the user to the copy of this License. Also, you must do one of these things:

- **a)** Accompany the work with the complete corresponding machine-readable source code for the Library including whatever changes were used in the work (which must be distributed under Sections 1 and 2 above); and, if the work is an executable linked with the Library, with the complete machine-readable “work that uses the Library”, as object code and/or source code, so that the user can modify the Library and then relink to produce a modified executable containing the modified Library. (It is understood that the user who changes the contents of definitions files in the Library will not necessarily be able to recompile the application to use the modified definitions.)
- **b)** Use a suitable shared library mechanism for linking with the Library. A suitable mechanism is one that (1) uses at run time a copy of the library already present on the user’s computer system, rather than copying library functions into the executable, and (2) will operate properly with a modified version of the library, if the user installs one, as long as the modified version is interface-compatible with the version that the work was made with.
- **c)** Accompany the work with a written offer, valid for at least three years, to give the same user the materials specified in Subsection 6a, above, for a charge no more than the cost of performing this distribution.
- **d)** If distribution of the work is made by offering access to copy from a designated place, offer equivalent access to copy the above specified materials from the same place.
- **e)** Verify that the user has already received a copy of these materials or that you have already sent this user a copy.

For an executable, the required form of the “work that uses the Library” must include any data and utility programs needed for reproducing the executable from it. However, as a special exception, the materials to be distributed need not include anything that is normally distributed (in either source or binary form) with the major components (compiler, kernel, and so on) of the operating system on which the executable runs, unless that component itself accompanies the executable. It may happen that this requirement contradicts the license restrictions of other proprietary libraries that do not normally accompany the operating system. Such a contradiction means you cannot use both them and the Library together in an executable that you distribute.

7. You may place library facilities that are a work based on the Library side-by-side in a single library together with other library facilities not covered by this License, and distribute such a combined library, provided that the separate distribution of the work based on the Library and of the other library facilities is otherwise permitted, and provided that you do these two things:

- **a)** Accompany the combined library with a copy of the same work based on the Library, uncombined with any other library facilities. This must be distributed under the terms of the Sections above.
- **b)** Give prominent notice with the combined library of the fact that part of it is a work based on the Library, and explaining where to find the accompanying uncombined form of the same work.

8. You may not copy, modify, sublicense, link with, or distribute the Library except as expressly provided under this License. Any attempt otherwise to copy, modify, sublicense, link with, or distribute the Library is void, and will automatically terminate your rights under this License. However, parties who have received copies, or rights, from you under this License will not have their licenses terminated so long as such parties remain in full compliance.

9. You are not required to accept this License, since you have not signed it. However, nothing else grants you permission to modify or distribute the Library or its derivative works. These actions

are prohibited by law if you do not accept this License. Therefore, by modifying or distributing the Library (or any work based on the Library), you indicate your acceptance of this License to do so, and all its terms and conditions for copying, distributing or modifying the Library or works based on it.

10. Each time you redistribute the Library (or any work based on the Library), the recipient automatically receives a license from the original licensor to copy, distribute, link with or modify the Library subject to these terms and conditions. You may not impose any further restrictions on the recipients' exercise of the rights granted herein. You are not responsible for enforcing compliance by third parties with this License.

11. If, as a consequence of a court judgment or allegation of patent infringement or for any other reason (not limited to patent issues), conditions are imposed on you (whether by court order, agreement or otherwise) that contradict the conditions of this License, they do not excuse you from the conditions of this License. If you cannot distribute so as to satisfy simultaneously your obligations under this License and any other pertinent obligations, then as a consequence you may not distribute the Library at all. For example, if a patent license would not permit royalty-free redistribution of the Library by all those who receive copies directly or indirectly through you, then the only way you could satisfy both it and this License would be to refrain entirely from distribution of the Library. If any portion of this section is held invalid or unenforceable under any particular circumstance, the balance of the section is intended to apply, and the section as a whole is intended to apply in other circumstances. It is not the purpose of this section to induce you to infringe any patents or other property right claims or to contest validity of any such claims; this section has the sole purpose of protecting the integrity of the free software distribution system which is implemented by public license practices. Many people have made generous contributions to the wide range of software distributed through that system in reliance on consistent application of that system; it is up to the author/donor to decide if he or she is willing to distribute software through any other system and a licensee cannot impose that choice. This section is intended to make thoroughly clear what is believed to be a consequence of the rest of this License.

12. If the distribution and/or use of the Library is restricted in certain countries either by patents or by copyrighted interfaces, the original copyright holder who places the Library under this License may add an explicit geographical distribution limitation excluding those countries, so that distribution is permitted only in or among countries not thus excluded. In such case, this License incorporates the limitation as if written in the body of this License.

13. The Free Software Foundation may publish revised and/or new versions of the Lesser General Public License from time to time. Such new versions will be similar in spirit to the present version, but may differ in detail to address new problems or concerns. Each version is given a distinguishing version number. If the Library specifies a version number of this License which applies to it and "any later version", you have the option of following the terms and conditions either of that version or of any later version published by the Free Software Foundation. If the Library does not specify a license version number, you may choose any version ever published by the Free Software Foundation.

14. If you wish to incorporate parts of the Library into other free programs whose distribution conditions are incompatible with these, write to the author to ask for permission. For software which is copyrighted by the Free Software Foundation, write to the Free Software Foundation; we sometimes make exceptions for this. Our decision will be guided by the two goals of preserving the free status of all derivatives of our free software and of promoting the sharing and reuse of software generally.

NO WARRANTY

15. BECAUSE THE LIBRARY IS LICENSED FREE OF CHARGE, THERE IS NO WARRANTY FOR THE LIBRARY, TO THE EXTENT PERMITTED BY APPLICABLE LAW. EXCEPT WHEN OTHERWISE STATED IN WRITING THE COPYRIGHT HOLDERS AND/OR OTHER PARTIES PROVIDE THE LIBRARY “AS IS” WITHOUT WARRANTY OF ANY KIND, EITHER EXPRESSED OR IMPLIED, INCLUDING, BUT NOT LIMITED TO, THE IMPLIED WARRANTIES OF MERCHANTABILITY AND FITNESS FOR A PARTICULAR PURPOSE. THE ENTIRE RISK AS TO THE QUALITY AND PERFORMANCE OF THE LIBRARY IS WITH YOU. SHOULD THE LIBRARY PROVE DEFECTIVE, YOU ASSUME THE COST OF ALL NECESSARY SERVICING, REPAIR OR CORRECTION. **16.** IN NO EVENT UNLESS REQUIRED BY APPLICABLE LAW OR AGREED TO IN WRITING WILL ANY COPYRIGHT HOLDER, OR ANY OTHER PARTY WHO MAY MODIFY AND/OR REDISTRIBUTE THE LIBRARY AS PERMITTED ABOVE, BE LIABLE TO YOU FOR DAMAGES, INCLUDING ANY GENERAL, SPECIAL, INCIDENTAL OR CONSEQUENTIAL DAMAGES ARISING OUT OF THE USE OR INABILITY TO USE THE LIBRARY (INCLUDING BUT NOT LIMITED TO LOSS OF DATA OR DATA BEING RENDERED INACCURATE OR LOSSES SUSTAINED BY YOU OR THIRD PARTIES OR A FAILURE OF THE LIBRARY TO OPERATE WITH ANY OTHER SOFTWARE), EVEN IF SUCH HOLDER OR OTHER PARTY HAS BEEN ADVISED OF THE POSSIBILITY OF SUCH DAMAGES.

END OF TERMS AND CONDITIONS

18 History

January 2015 Release manual for NetCom Plus

February 2015 Add WLAN configuration
Add Modbus/TCP on NetCom Plus 811 DIO

May 2015 Complete the list of models

September_2015 More pictures, and technical data refined
Firmware Version 3.2.2
Support for Port Expansion via USB-COM Plus models
Instructions (FAQ) for Linux use

January 2016 Remote Access by viaVPN documented (Chapter 11)
PPP Option removed
Orange LED for 3G/4G mobile network added
Firmware Version 3.3.1

August 2016 New Driver for NetCom⁺
Firmware Version 3.3.4

September 2016 Operation Modes corrected
Firmware Version 3.3.5

March 2017 Add Models NetCom Plus 1613 and NetCom Plus Mini
Firmware Version 3.4.1 with WPA-Enterprise(6.2.1.3), viaVPN(11.3) activation, UPnP(6)
and RxTimeout(6.2.2.1)
Warning for Wall Mount Kit (long screws not allowed)

April 2017 NetCom Plus Mini available as NetCom Plus 111 Mini and NetCom Plus 113 Mini

February 2019 Models NetCom Plus Mini phased out

May 2019 Updated Manual for Driver Version 2.0.3 / Firmware Version 3.4.7
Driver 2.0.3: New Look, modified Options, extra version Windows 10
Firmware 3.4.7: Firmware Update

September 2019 Dimensions added for cases