



NexAIoT Co., Ltd.

IoT Automation Solutions Business Group

Industrial Fanless Computer

NISE 3800 Series

User Manual

CONTENTS

Preface

Copyright	iv
Disclaimer	iv
Acknowledgements	iv
Regulatory Compliance Statements	iv
Declaration of Conformity	iv
RoHS Compliance	v
Warranty and RMA	vi
Safety Information	viii
Installation Recommendations	viii
Safety Precautions	ix
Technical Support and Assistance	xi
Conventions Used in this Manual	xi
Global Service Contact Information	xii
Package Contents	xiv
Ordering Information	xix

Chapter 1: Product Introduction

NISE 3800E/E2/P2/P2E Overview	1
Key Features	1
NISE 3800E-H110/NISE 3800R Overview	2
Key Features	2
Hardware Specifications	3
Knowing Your NISE 3800 Series	6
NISE 3800E/E2/P2/P2E & NISE 3800R	6

NISE 3800E-H110	7
NISE 3800E & NISE 3800R	8
NISE 3800E2/P2/P2E	9
NISE 3800E-H110	10
Mechanical Dimensions	11

Chapter 2: Jumpers and Connectors

Before You Begin	15
Precautions	15
Chassis Ground Isolation	16
Functional Ground Isolation	16
Jumper Settings	17
Locations of the Jumpers and Connectors for NISE 3800E/E2/P2/P2E & NISE 3800R	18
Locations of the Jumpers and Connectors for NISE 3800E-H110	20
Jumpers and DIP Switch Settings	22
AT/ATX Power Select	22
PCI Express* Bifurcation	22
Clear CMOS Select	23
COM3 RS232 RI# Power Select	23
Connector Pin Definitions	24
External I/O Interfaces - Front Panel	24
Power Button	24
LED Indicators	24
SIM Card Socket	25
DisplayPort	25

External I/O Interfaces - Rear Panel.....	26
9V - 30V DC Power Input.....	26
Remote Power On/Off & S3 Connector	26
LAN3 and USB 3.0 Ports.....	27
LAN2 and USB 3.0 Ports.....	28
LAN1 and USB 2.0 Ports.....	29
DVI-D Connector.....	29
HDMI.....	30
Internal Connectors.....	31
Reset Connector	31
FW BIOS Connector	31
SMBus	32
SATA Power Connectors.....	32
SATA Connectors	33
Line-in Pin Header	33
Speaker-out Pin Header.....	34
Debug Connector	34
COM Port 1 Connector	35
COM Port 2 Connector	35
COM Port 3 Connector	36
COM Port 4 Connector	36
GPIO Pin Header	37
Fan1 Connector	37
Fan2 Connector	38
USB 2.0 Connector	38
LED Pin Header	39
LED Pin Header	39
MCU Connector.....	40
Mini-PCIe.....	41
Mini-PCIe Connector.....	42
NGFF (M.2 Key M [2242]) Connector (SATA/PCIe x4).....	43

Chapter 3: System Setup

Removing the Top Cover	44
Wallmount Brackets.....	45
Removing the Bottom Cover.....	46
Installing a CPU.....	47
Installing a 3G/GSM Module.....	50
Installing an mSATA Module	52
Installing a SO-DIMM Memory Module	54
Installing a SIM Card	55
Installing an M.2 Card.....	56
Installing a SATA Hard Drive	58
Installing a PCIe/PCI Expansion Card.....	61
PCI Volts Configuration on NISE 3800 Riser Cards.....	62

Chapter 4: BIOS Setup

About BIOS Setup.....	63
When to Configure the BIOS.....	63
Default Configuration	64
Entering Setup.....	64
Legends	64
BIOS Setup Utility.....	66
Main	66
Advanced	67
Chipset.....	75
Security.....	79
Boot.....	80
Save & Exit	81

PREFACE

Copyright

This publication, including all photographs, illustrations and software, is protected under international copyright laws, with all rights reserved. No part of this manual may be reproduced, copied, translated or transmitted in any form or by any means without the prior written consent from NEXCOM International Co., Ltd.

Disclaimer

The information in this document is subject to change without prior notice and does not represent commitment from NEXCOM International Co., Ltd. However, users may update their knowledge of any product in use by constantly checking its manual posted on our website: <http://www.nexcom.com>. NEXCOM shall not be liable for direct, indirect, special, incidental, or consequential damages arising out of the use of any product, nor for any infringements upon the rights of third parties, which may result from such use. Any implied warranties of merchantability or fitness for any particular purpose is also disclaimed.

Acknowledgements

NISE 3800E, NISE 3800E2, NISE 3800P2, NISE 3800P2E, NISE 3800E-H110 and NISE 3800R are trademarks of NEXCOM International Co., Ltd. All other product names mentioned herein are registered trademarks of their respective owners.

Regulatory Compliance Statements

This section provides the FCC compliance statement for Class A devices and describes how to keep the system CE compliant.

Declaration of Conformity

FCC

This equipment has been tested and verified to comply with the limits for a Class A digital device, pursuant to Part 15 of FCC Rules. These limits are designed to provide reasonable protection against harmful interference when the equipment is operated in a commercial environment. This equipment generates, uses, and can radiate radio frequency energy and, if not installed and used in accordance with the instructions, may cause harmful interference to radio communications. Operation of this equipment in a residential area (domestic environment) is likely to cause harmful interference, in which case the user will be required to correct the interference (take adequate measures) at their own expense.

CE

The product(s) described in this manual complies with all applicable European Union (CE) directives if it has a CE marking. For computer systems to remain CE compliant, only CE-compliant parts may be used. Maintaining CE compliance also requires proper cable and cabling techniques.

RoHS Compliance



NEXCOM RoHS Environmental Policy and Status Update

NEXCOM is a global citizen for building the digital infrastructure. We are committed to providing green products and services, which are compliant with European Union RoHS (Restriction on Use of Hazardous Substance in Electronic Equipment) directive 2011/65/EU, to be your trusted green partner and to protect our environment.

RoHS restricts the use of Lead (Pb) < 0.1% or 1,000ppm, Mercury (Hg) < 0.1% or 1,000ppm, Cadmium (Cd) < 0.01% or 100ppm, Hexavalent Chromium (Cr6+) < 0.1% or 1,000ppm, Polybrominated biphenyls (PBB) < 0.1% or 1,000ppm, and Polybrominated diphenyl Ethers (PBDE) < 0.1% or 1,000ppm.

In order to meet the RoHS compliant directives, NEXCOM has established an engineering and manufacturing task force to implement the introduction of green products. The task force will ensure that we follow the standard NEXCOM development procedure and that all the new RoHS components and new manufacturing processes maintain the highest industry quality levels for which NEXCOM are renowned.

The model selection criteria will be based on market demand. Vendors and suppliers will ensure that all designed components will be RoHS compliant.

How to recognize NEXCOM RoHS Products?

For existing products where there are non-RoHS and RoHS versions, the suffix "(LF)" will be added to the compliant product name.

All new product models launched after January 2013 will be RoHS compliant. They will use the usual NEXCOM naming convention.

Warranty and RMA

NEXCOM Warranty Period

NEXCOM manufactures products that are new or equivalent to new in accordance with industry standard. NEXCOM warrants that products will be free from defect in material and workmanship for 2 years, beginning on the date of invoice by NEXCOM.

NEXCOM Return Merchandise Authorization (RMA)

- Customers shall enclose the “NEXCOM RMA Service Form” with the returned packages.
- Customers must collect all the information about the problems encountered and note anything abnormal or, print out any on-screen messages, and describe the problems on the “NEXCOM RMA Service Form” for the RMA number apply process.
- Customers can send back the faulty products with or without accessories (manuals, cable, etc.) and any components from the card, such as CPU and RAM. If the components were suspected as part of the problems, please note clearly which components are included. Otherwise, NEXCOM is not responsible for the devices/parts.
- Customers are responsible for the safe packaging of defective products, making sure it is durable enough to be resistant against further damage and deterioration during transportation. In case of damages occurred during transportation, the repair is treated as “Out of Warranty.”
- Any products returned by NEXCOM to other locations besides the customers’ site will bear an extra charge and will be billed to the customer.

Repair Service Charges for Out-of-Warranty Products

NEXCOM will charge for out-of-warranty products in two categories, one is basic diagnostic fee and another is component (product) fee.

System Level

- Component fee: NEXCOM will only charge for main components such as SMD chip, BGA chip, etc. Passive components will be repaired for free, ex: resistor, capacitor.
- Items will be replaced with NEXCOM products if the original one cannot be repaired. Ex: motherboard, power supply, etc.
- Replace with 3rd party products if needed.
- If RMA goods can not be repaired, NEXCOM will return it to the customer without any charge.

Board Level

- Component fee: NEXCOM will only charge for main components, such as SMD chip, BGA chip, etc. Passive components will be repaired for free, ex: resistors, capacitors.
- If RMA goods can not be repaired, NEXCOM will return it to the customer without any charge.

Warnings

Read and adhere to all warnings, cautions, and notices in this guide and the documentation supplied with the chassis, power supply, and accessory modules. If the instructions for the chassis and power supply are inconsistent with these instructions or the instructions for accessory modules, contact the supplier to find out how you can ensure that your computer meets safety and regulatory requirements.

Cautions

Electrostatic discharge (ESD) can damage system components. Do the described procedures only at an ESD workstation. If no such station is available, you can provide some ESD protection by wearing an antistatic wrist strap and attaching it to a metal part of the computer chassis.

Safety Information

Before installing and using the device, note the following precautions:

- Read all instructions carefully.
- Do not place the unit on an unstable surface, cart, or stand.
- Follow all warnings and cautions in this manual.
- When replacing parts, ensure that your service technician uses parts specified by the manufacturer.
- Avoid using the system near water, in direct sunlight, or near a heating device.
- The load of the system unit does not solely rely for support from the rackmounts located on the sides. Firm support from the bottom is highly necessary in order to provide balance stability.
- The computer is provided with a battery-powered real-time clock circuit. There is a danger of explosion if battery is incorrectly replaced. Replace only with the same or equivalent type recommended by the manufacturer. Discard used batteries according to the manufacturer's instructions.



Danger of explosion if battery is incorrectly replaced. Replace with the same or equivalent type recommended by the manufacturer. Discard used batteries according to the manufacturer's instructions.

Installation Recommendations

Ensure you have a stable, clean working environment. Dust and dirt can get into components and cause a malfunction. Use containers to keep small components separated.

Adequate lighting and proper tools can prevent you from accidentally damaging the internal components. Most of the procedures that follow require only a few simple tools, including the following:

- A Philips screwdriver
- A flat-tipped screwdriver
- A grounding strap
- An anti-static pad

Using your fingers can disconnect most of the connections. It is recommended that you do not use needle-nose pliers to disconnect connections as these can damage the soft metal or plastic parts of the connectors.

Safety Precautions

1. Read these safety instructions carefully.
2. Keep this User Manual for later reference.
3. Disconnect this equipment from any AC outlet before cleaning. Use a damp cloth. Do not use liquid or spray detergents for cleaning.
4. For plug-in equipment, the power outlet socket must be located near the equipment and must be easily accessible.
5. Keep this equipment away from humidity.
6. Put this equipment on a stable surface during installation. Dropping it or letting it fall may cause damage.
7. The openings on the enclosure are for air convection to protect the equipment from overheating. **DO NOT COVER THE OPENINGS.**
8. Make sure the voltage of the power source is correct before connecting the equipment to the power outlet.
9. Place the power cord in a way so that people will not step on it. Do not place anything on top of the power cord. Use a power cord that has been approved for use with the product and that it matches the voltage and current marked on the product's electrical range label. The voltage and current rating of the cord must be greater than the voltage and current rating marked on the product.
10. All cautions and warnings on the equipment should be noted.
11. If the equipment is not used for a long time, disconnect it from the power source to avoid damage by transient overvoltage.
12. Never pour any liquid into an opening. This may cause fire or electrical shock.
13. Never open the equipment. For safety reasons, the equipment should be opened only by qualified service personnel.
14. If one of the following situations arises, get the equipment checked by service personnel:
 - a. The power cord or plug is damaged.
 - b. Liquid has penetrated into the equipment.
 - c. The equipment has been exposed to moisture.
 - d. The equipment does not work well, or you cannot get it to work according to the user's manual.
 - e. The equipment has been dropped and damaged.
 - f. The equipment has obvious signs of breakage.
15. Do not place heavy objects on the equipment.
16. The unit uses a three-wire ground cable which is equipped with a third pin to ground the unit and prevent electric shock. Do not defeat the purpose of this pin. If your outlet does not support this kind of plug, contact your electrician to replace your obsolete outlet.
17. **CAUTION:** DANGER OF EXPLOSION IF BATTERY IS INCORRECTLY REPLACED. REPLACE ONLY WITH THE SAME OR EQUIVALENT TYPE RECOMMENDED BY THE MANUFACTURER. DISCARD USED BATTERIES ACCORDING TO THE MANUFACTURER'S INSTRUCTIONS.

18. Insert the positive and negative wires into the V+ and V- contacts on the terminal block connector.
19. Tighten the wire-clamps screws to prevent the DC wires coming loose.
20. Take into consideration the following guidelines before wiring the device.
21. The terminal block is suitable for 30-12 AWG (16A). Torque value 5 lb-in.
22. The temperature rating of the input connection cable should be higher than 95°C.
23. **WARNING!** This equipment is intended for installation in a Restricted Access Location only.
AVERTISSEMENT! Cet équipement est destiné à être installé dans un lieu d'accès restreint uniquement.
24. There must be a disconnect device in front of "NISE 3800 series" to keep the worker or field side maintainer be cautious and aware to close the general power supply before they start to do maintenance. The disconnect device hereby means a 20A circuit-breaker.
25. Power installation must be performed with qualified electrician and followed with National Electrical Code, ANSI/NFPA 70 and Canadian Electrical Code, Part I, CSA C22.1.
26. Tolerance within maximum operating voltage range 9 VDC to 36 VDC, 13.3A-4A.
27. **WARNING!** RISK OF EXPLOSION IF BATTERY IS REPLACED BY INCORRECT BATTERY TYPE. DISPOSE OF USED BATTERIES ACCORDING TO THE INSTRUCTIONS.
ATTENTION! IL Y A RISQUE D'EXPLOSION SI LA BATTERIE EST REMPLACÉE PAR UNE BATTERIE DE TYPE INCORRECT. METTRE AU REBUT LES BATTERIES USAGÉES CONFORMÉMENT AUX INSTRUCTIONS.

Technical Support and Assistance

1. For the most updated information of NEXCOM products, visit NEXCOM's website at www.nexcom.com.
2. For technical issues that require contacting our technical support team or sales representative, please have the following information ready before calling:
 - Product name and serial number
 - Detailed information of the peripheral devices
 - Detailed information of the installed software (operating system, version, application software, etc.)
 - A complete description of the problem
 - The exact wordings of the error messages

Warning!

1. Handling the unit: carry the unit with both hands and handle it with care.
2. Maintenance: to keep the unit clean, use only approved cleaning products or clean with a dry cloth.
3. CompactFlash: Turn off the unit's power before inserting or removing a CompactFlash storage card.

Conventions Used in this Manual



Warning:

Information about certain situations, which if not observed, can cause personal injury. This will prevent injury to yourself when performing a task.



Caution:

Information to avoid damaging components or losing data.



Note:

Provides additional information to complete a task easily.



Safety Warning: This equipment is intended for installation in a Restricted Access Location only.

Global Service Contact Information

Headquarters

NEXCOM International Co., Ltd.

9F, No. 920, Zhongzheng Rd.,
Zhonghe District, New Taipei City, 23586,
Taiwan, R.O.C.
Tel: +886-2-8226-7786
Fax: +886-2-8226-7782
www.nexcom.com

Asia

Taiwan

NexAIoT Headquarters

Industry 4.0 and Cloud Services

13F, No.922, Zhongzheng Rd.,
Zhonghe District, New Taipei City,
23586, Taiwan, R.O.C.
Tel: +886-2-8226-7796
Fax: +886-2-8226-7926
Email: jacobhuang@nexaiot.com
www.nexaiot.com

NexAIoT Co., Ltd.

Taichung Office

16F, No.250, Sec.2, Chongde Rd.,
Beitun District,
Taichung City, 406, Taiwan, R.O.C.
Tel: +886-4-2249-1179
Fax: +886-4-2249-1172
Email: jacobhuang@nexaiot.com
www.nexaiot.com

NexCOBOT Taiwan Co., Ltd.

13F, No.916, Zhongzheng Rd.,
Zhonghe District,
New Taipei City, 23586, Taiwan, R.O.C.
Tel: +886-2-8226-7786
Fax: +886-2-8226-7926
Email: jennyshern@nexcobot.com
www.nexcobot.com

GreenBase Technology Corp.

13F, No.922, Zhongzheng Rd.,
Zhonghe District,
New Taipei City, 23586, Taiwan, R.O.C.
Tel: +886-2-8226-7786
Fax: +886-2-8226-7900
Email: vivianlin@nexcom.com.tw
www.nexcom.com.tw

DivioTec Inc.

19F-1A, No.97, Sec.4, ChongXin Rd.,
Sanhong District,
New Taipei City, 24161, Taiwan, R.O.C.
Tel: +886-2-8976-3077
Email: sales@diviotec.com
www.diviotec.com

AIoT Cloud Corp.

13F, No.922, Zhongzheng Rd.,
Zhonghe District,
New Taipei City, 23586, Taiwan, R.O.C.
Tel: +886-2-8226-7786
Fax: +886-2-8226-7782
Email: alantsai@aiotcloud.net
www.aiotcloud.dev

EMBUX TECHNOLOGY CO., LTD.

13F, No.916, Zhongzheng Rd.,
Zhonghe District,
New Taipei City, 23586, Taiwan, R.O.C.
Tel: +886-2-8226-7786
Fax: +886-2-8226-7782
Email: info@embux.com
www.embux.com

TMR TECHNOLOGIES CO., LTD.

13F, No.916, Zhongzheng Rd.,
Zhonghe District,
New Taipei City, 23586, Taiwan, R.O.C.
Tel: +886-2-8226-7786
Fax: +886-2-8226-7782
Email: services@tmrtek.com
www.tmrtek.com

China NEXSEC Incorporated

201, Floor 2, Unit 2, Building 15, Yard 3,
Gaolizhang Road, Haidian District,
Beijing, 100094, China
Tel: +86-10-5704-2680
Fax: +86-10-5704-2681
Email: marketing@nexsec.cn
www.nexsec.cn

NEXCOM Shanghai

Room 406-407, Building C, No 154, Lane 953,
Jianchuan Road, Minhang District,
Shanghai, 201108, China
Tel: +86-21-5278-5868
Fax: +86-21-3251-6358
Email: sales@nexcom.cn
www.nexcom.cn

NEXCOM Surveillance Technology Corp.

Floor 8, Building B3, Xiufeng Industrial Zone,
GanKeng Community, Buji Street,
LongGang District,
ShenZhen, 518112, China
Tel: +86-755-8364-7768
Fax: +86-755-8364-7738
Email: steveyang@nexcom.com.tw
www.nexcom.cn

NEXGOL Chongqing

1st Building No.999,
Star Boulevard, Yongchuan Dist,
Chongqing City, 402160, China
Tel: +86-23-4960-9080
Fax: +86-23-4966-5855
Email: sales@nexgol.com.cn
www.nexcom.cn

Beijing NexGemo Technology Co.,Ltd.

Room 205, No.1, Fazhan Rd.,
Beijing International Information Industry Base,
Changping District,
Beijing, 102206, China
Tel: +86-10-8072-2025
Fax: +86-10-8072-2022
Email: sales@nexgemo.cn
www.nexgemo.com

Japan

NEXCOM Japan

9F, Tamachi Hara Bldg.,
4-11-5, Shiba Minato-ku,
Tokyo, 108-0014, Japan
Tel: +81-3-5419-7830
Fax: +81-3-5419-7832
Email: sales@nexcom-jp.com
www.nexcom-jp.com

America

USA NEXCOM USA

46665 Fremont Blvd.,
Fremont CA 94538, USA
Tel: +1-510-656-2248
Fax: +1-510-656-2158
Email: sales@nexcom.com
www.nexcomusa.com

Europe

United Kingdom NEXCOM EUROPE

10 Vincent Avenue,
Crownhill Business Centre,
Milton Keynes, Buckinghamshire
MK8 0AB, United Kingdom
Tel: +44-1908-267121
Fax: +44-1908-262042
Email: sales.uk@nexcom.eu
www.nexcom.com

Package Contents

Before continuing, verify that the NISE 3800 series package that you received is complete. Your package should have all the items listed in the following table.

NISE 3800E

Item	Part Number	Description	Qty
1	4NCPF00310X00	Terminal Blocks 3P Phoenix Contact:1803581 3.81mm Female DIP Green	1
2	4NCPM00302X00	Terminal Blocks 3P Phoenix Contact:1777992 5.08mm Male DIP Green	1
3	50311F0100X00	Round Head Screw w/Spring+Flat Washer Long Fei:P3x6L P3x6 iso/SW6x0.5 NI	2
4	50311F0143X00	Flat Head Screw Long Fei:F#6-32x8 F#6-32x8 TROX 10 NI+ Nylok	1
5	50311F0315X00	Round Head Screw Long Fei:P6#32T T10 Nylok P6#32T Outer Teeth Washer T10 Nylok	1
6	50311F0326X00	Flat Head Screw Long Fei:F3x5 Nylok NI+Heat Treatment F3x5 Nylok NI+Heat Treatment	4
7	50311F0330X00	Round Head Screw Long Fei:P2x3 ISO+Nylon P2x3 NI Nylok	4
8	50311P0001X00	Price For Plastic Screw HS6-75P 75mm	1
9	50322P0002X00	Plastic Nut Gin Lian:M6HW 10mmx6mm	1
10	5044440090X00	Thermal Pad APUS:3A2015001001500 15x10x1.5mm XR-PE	1
11	5061600245X00	Washer Kang Yang:TW-320-01 10.4x6.4mm T=1mm Nylon Black	4
12	60177B0364X00	NISE 3800E Quick Reference Guide VER:B SIZE:A4 Kramer	1

NISE 3800E-H110

Item	Part Number	Description	Qty
1	4NCPF00310X00	Terminal Blocks 3P Phoenix Contact:1803581 3.81mm Female DIP Green	1
2	4NCPM00302X00	Terminal Blocks 3P Phoenix Contact:1777992 5.08mm Male DIP Green	1
3	50311F0100X00	Round Head Screw w/Spring+Flat Washer Long Fei:P3x6L P3x6 iso/SW6x0.5 NI	2
4	50311F0143X00	Flat Head Screw Long Fei:F#6-32x8 F#6-32x8 TROX 10 NI+ Nylok	1
5	50311F0315X00	Round Head Screw Long Fei:P6#32T T10 Nylok P6#32T Outer Teeth Washer T10 Nylok	1
6	50311F0326X00	Flat Head Screw Long Fei:F3x5 Nylok NI+Heat Treatment F3x5 Nylok NI+Heat Treatment	4
7	50311F0330X00	Round Head Screw Long Fei:P2x3 ISO+NYLON P2x3 NI Nylok	4
8	50311P0001X00	Price For Plastic Screw HS6-75P 75mm	1
9	50311P0014X00	P Head Screw Kang Yang:M3-5 5.5x2.1x5mm Plastics	1
10	50322P0002X00	Plastic Nut Gin Lian:M6HW 10mmx6mm	1
11	5044440090X00	Thermal Pad APUS:3A2015001001500 15x10x1.5mm XR-PE	1
12	5061600106X00	Washer Kang Yang:WS6-3.2-1A D6.0mm T=1.0mm	2
13	5061600245X00	Washer Kang Yang:TW-320-01 10.4x6.4mm T=1mm Nylon Black	4
14	60177B0364X00	NISE 3800E Quick Reference Guide VER:B SIZE:A4 Kramer	1
15	6029900037X00	Dow Corning 340 Silicone Heat Sink Compound (3g)	1

NISE 3800R

Item	Part Number	Description	Qty
1	4NCPF00310X00	Terminal Blocks 3P Phoenix Contact:1803581 3.81mm Female DIP Green	1
2	4NCPM00302X00	Terminal Blocks 3P Phoenix Contact:1777992 5.08mm Male DIP Green	1
3	50311F0143X00	Flat Head Screw Long Fei:F#6-32x8 F#6-32x8 Trox 10 NI+ Nylok	1
4	50311F0315X00	Round Head Screw Long Fei:P6#32T T10 Nylok P6#32T Outer Teeth Washer T10 Nylok	1
5	50311F0326X00	Flat Head Screw Long Fei:F3x5 Nylok NI+Heat Treatment F3x5 Nylok NI+Heat Treatment	8
6	50311F0330X00	Round Head Screw Long Fei:P2x3 ISO+Nylon P2x3 NI Nylok	4
7	50311P0014X00	P Head Screw Kang Yang:M3-5 5.5x2.1x5mm Plastics	1
8	5044440090X00	Thermal Pad APUS:3A2015001001500 15x10x1.5mm XR-PE	1
9	5061600106X00	Washer Kang Yang:WS6-3.2-1A D6.0mm T=1.0mm	2
10	5061600245X00	Washer Kang Yang:TW-320-01 10.4x6.4mm T=1mm Nylon Black	4
11	60177B0364X00	NISE 3800E Quick Reference Guide VER:B SIZE:A4 Kramer	1
12	6029900037X00	Dow Corning 340 Silicone Heat Sink Compound (3g)	1

NISE 3800R

Item	Part Number	Description	Qty
1	4NCPF00310X00	Terminal Blocks 3P Phoenix Contact:1803581 3.81mm Female DIP Green	1
2	4NCPM00302X00	Terminal Blocks 3P Phoenix Contact:1777992 5.08mm Male DIP Green	1
3	50311F0143X00	Flat Head Screw Long Fei:F#6-32x8 F#6-32x8 Trox 10 NI+ Nylok	1
4	50311F0315X00	Round Head Screw Long Fei:P6#32T T10 Nylok P6#32T Outer Teeth Washer T10 Nylok	1
5	50311F0326X00	Flat Head Screw Long Fei:F3x5 Nylok NI+Heat Treatment F3x5 Nylok NI+Heat Treatment	8
6	50311F0330X00	Round Head Screw Long Fei:P2x3 ISO+Nylon P2x3 NI Nylok	4
7	50311P0014X00	P Head Screw Kang Yang:M3-5 5.5x2.1x5mm Plastics	1
8	5044440090X00	Thermal Pad APUS:3A2015001001500 15x10x1.5mm XR-PE	1
9	5061600106X00	Washer Kang Yang:WS6-3.2-1A D6.0mm T=1.0mm	2
10	5061600245X00	Washer Kang Yang:TW-320-01 10.4x6.4mm T=1mm Nylon Black	4
11	60177B0364X00	NISE 3800E Quick Reference Guide VER:B SIZE:A4 Kramer	1
12	6029900037X00	Dow Corning 340 Silicone Heat Sink Compound (3g)	1

NISE 3800E2/NISE 3800P2/NISE 3800P2E

Item	Part Number	Description	Qty
1	4NCPF00310X00	Terminal Blocks 3P Phoenix Contact:1803581 3.81mm Female DIP Green	1
2	4NCPM00302X00	Terminal Blocks 3P Phoenix Contact:1777992 5.08mm Male DIP Green	1
3	50311F0100X00	Round Head Screw w/Spring+Flat Washer Long Fei:P3x6L P3x6 iso/SW6x0.5 NI	2
4	50311F0143X00	Flat Head Screw Long Fei:F#6-32x8 F#6-32x8 TROX 10 NI+ Nylok	1
5	50311F0315X00	Round Head Screw Long Fei:P6#32T T10 Nylok P6#32T Outer Teeth Washer T10 Nylok	1
6	50311F0326X00	Flat Head Screw Long Fei:F3x5 Nylok NI+Heat Treatment F3x5 Nylok NI+Heat Treatment	4
7	50311F0330X00	Round Head Screw Long Fei:P2x3 ISO+Nylon P2x3 NI Nylok	4
8	50311P0001X00	Price for Plastic Screw HS6-75P 75mm	2
9	50311P0014X00	P Head Screw Kang Yang:M3-5 5.5X2.1x5mm Plastics	1
10	50322P0002X00	Plastic Nut Gin Lian:M6HW 10mmx6mm	2
11	5044440090X00	Thermal Pad APUS:3A2015001001500 15x10x1.5mm XR-PE	1
12	5061600106X00	Washer Kang Yang:WS6-3.2-1A D6.0mm T=1.0mm	2
13	5061600245X00	Washer Kang Yang:TW-320-01 10.4x6.4mm T=1mm Nylon Black	4
14	60177B0364X00	NISE 3800E Quick Reference Guide VER:B SIZE:A4 Kramer	1
15	6029900037X00	Dow Corning 340 Silicone Heat Sink Compound (3g)	1

Ordering Information

The following information below provides ordering information for the NISE 3800 series.

- **Barebone**

NISE 3800E System (P/N: 10J00380003X0)

- 6th & 7th generation Intel® Core™ i7/i5/i3 fanless system with one PCIe x4 expansion

NISE 3800E2 System (P/N: 10J00380002X0)

- 6th & 7th generation Intel® Core™ i7/i5/i3 fanless system with two PCIe x4 expansions

NISE 3800P2 System (P/N: 10J00380005X0)

- 6th & 7th generation Intel® Core™ i7/i5/i3 fanless system with two PCI expansions

NISE 3800P2E System (P/N: 10J00380004X0)

- 6th & 7th generation Intel® Core™ i7/i5/i3 fanless system with one PCI and one PCIe x4 expansion

NISE 3800E-H110 System (P/N: 10J00380000X0)

- 6th & 7th generation Intel® Core™ i7/i5/i3 fanless system with one PCIe x4 expansion

NISE 3800R System (P/N: 10J00380001X0)

- 6th & 7th generation Intel® Core™ i7/i5/i3 fanless system with two external 2.5" HDD brackets to support RAID 0/1

- **24V, 120W AC to DC power adapter w/o power cord (P/N: 7400120029X00, Lite-On)**



Optional Power Adapter: Please use an appropriate AC/DC power adapter compliant with CE or UL safety regulations.

CHAPTER 1: PRODUCT INTRODUCTION

NISE 3800E/E2/P2/P2E Overview



NISE 3800E Front View



NISE 3800E Rear View



NISE 3800E2/P2/P2E Front View



NISE 3800E2/P2/P2E Rear View

Key Features

- Support 6th & 7th generation Intel® Core™ i7/i5/i3 LGA socket type embedded processor
- Intel® Q170 PCH
- Support 1 x 2.5" SATA HDD & 1 x External M.2 Key M (2242) socket
- 1 x DVI-D, 1 x DP, and 1 x HDMI with independent display support
- Three Intel® GbE LAN ports; support WoL, teaming and PXE
- 4 x USB 3.0 and 2 x USB 2.0
- 2 x RS232/422/485 and 2 x RS232 (NISE 3800E2/P2/P2E)
- 2 x RS232/422/485 and 1 x RS232 (NISE 3800E/E-H110/R)
- 2 x Internal mini-PCIe sockets support optional Wi-Fi/3.5G/mSATA/Fieldbus
- Support +9V to 30VDC input; ATX power mode
- One PCIe x4 expansion (NISE 3800E)
- 2 x PCI or PCIe x4 expansions (NISE 3800E2/P2/P2E)

NISE 3800E-H110/NISE 3800R Overview



NISE 3800E-H110 Front View



NISE 3800E-H110 Rear View



NISE 3800R Front View



NISE 3800R Rear View

Key Features

- Support 6th & 7th generation Intel® Core™ i7/i5/i3 LGA socket type embedded processor
- Intel® H110 PCH (NISE 3800E-H110); Intel® Q170 PCH (NISE 3800R)
- Support 1 x 2.5" SATA HDD (NISE 3800E-H110)
- 1 x DVI-D and 1 x HDMI with independent display support (NISE 3800E-H110)
- 1 x DVI-D, 1 x DP, and 1 x HDMI with independent display support (NISE 3800R)
- Two Intel® GbE LAN ports; support WoL, teaming and PXE (NISE 3800E-H110)
- Three Intel® GbE LAN ports; support WoL, teaming and PXE (NISE 3800R)
- 1 x SIM card socket (NISE 3800E-H110)
- Support 1 x 2.5" SATA HDD & 1 x External M.2 Key M (2242) socket
- 4 x USB 3.0 and 2 x USB 2.0
- 2 x RS232/422/485 with auto flow control and **1 x RS232 via COM 3**
- 2 x Internal mini-PCIe sockets support optional Wi-Fi/3.5G/mSATA/Fieldbus
- Support +9V to 30VDC input; ATX power mode
- One PCIe x4 expansion (NISE 3800E-H110)
- 1 x Two 2.5" HDD bracket trays (NISE 3800R)

Hardware Specifications

CPU Support

- Support 6th & 7th generation Intel® Core™ i7/i5/i3 LGA socket type embedded processors
 - Intel® Core™ i7-7700T, Quad Core, 2.9GHz, 8M Cache
 - Intel® Core™ i5-7500T, Quad Core, 2.7GHz, 6M Cache
 - Intel® Core™ i3-7101TE, Dual Core, 3.9GHz, 3M Cache
 - Intel® Celeron® G3930TE 2.7GHz, 2M Cache
 - Intel® Core™ i7-6700TE, Quad Core, 2.4GHz, 8M Cache
 - Intel® Core™ i5-6500TE, Quad Core, 2.3GHz, 6M Cache
 - Intel® Core™ i3-6100TE, Dual Core, 2.7GHz, 4M Cache
 - Intel® Pentium® Processor G4400TE 2.4GHz, 3M Cache
 - Intel® Celeron® Processor G3900TE 2.3GHz, 2M Cache
- Turbo-boost disabled by default

Main Memory

- 2 x DDR4 1866/2133 SO-DIMM sockets, support up to 32GB

Display Option

NISE 3800E/E2/P2/P2E & NISE 3800R

- Three Independent Display
 - HDMI + DP + DVI-D
- Dual Independent Display
 - HDMI + DP
 - HDMI + DVI-D
 - DP + DVI-D

NISE 3800E-H110

- Two Independent Display
 - HDMI + DVI-D

Front I/O Interface Status LEDs

NISE 3800E/E2/P2/P2E & NISE 3800R

- 3 x LAN active LEDs
- 2 x GPO status/COM1/2 TX/RX LEDs
- 1 x HDD access LED

NISE 3800E-H110

- 2 x LAN active LEDs
- 2 x GPO status/COM1/2 TX/RX LEDs
- 1 x HDD access LED

Front I/O Interface

NISE 3800E/E2/P2/P2E & NISE 3800R

- 1 x ATX power on/off switch
- 1 x DP
- 1 x Line-out and 1 x Mic-in
- 2 x Antenna holes
- 1 x External M.2 Key M socket (2242)
- 1 x SIM card holder

NISE 3800E-H110

- 1 x ATX power on/off switch
- 2 x USB 2.0 ports (500mA per each)
- 1 x Line-out and 1 x Mic-in
- 2 x Antenna holes
- 1 x SIM card holder

Rear I/O Interface

NISE 3800E/E2/P2/P2E & NISE 3800R

- 4 x DB9 or 3 x DB9
 - COM1: RS232/422/485 auto flow control
 - COM2: RS232/422/485 auto flow control
 - COM3: RS232 (NISE 3800E2/P2/P2E/E/R)
 - COM4: RS232 (NISE 3800E2/P2/P2E)
- 4 x USB 3.0 ports (900mA per each)
- 2 x USB 2.0 ports (500mA per each)
- 1 x DVI-D port
- 1 x HDMI port
- 3 x Intel® I210IT GbE LAN ports; support WoL, teaming and PXE
- 1 x 2-pin remote power on/off switch
- +9V to 30V DC input

NISE 3800E-H110

- 3 x DB9
 - COM1/2: RS232/422/485 auto flow control
 - COM3: RS232
- 4 x USB 3.0 ports (900mA per each)
- 1 x DVI-D port
- 1 x HDMI port
- 2 x Intel® I210IT GbE LAN ports; support WoL, teaming and PXE
- 1 x 2-pin remote power on/o switch
- +9V to 30V DC input

Storage Device

NISE 3800E/E2/P2/P2E

- 1 x mSATA (SATA 3.0)
- 1 x 2.5" HDD (SATA 3.0)

NISE 3800E-H110

- 1 x mSATA (internal mini-PCIe socket)
- 1 x 2.5" HDD (SATA 3.0)

NISE 3800R

- 1 x mSATA (SATA 3.0)
- 2 x 2.5" HDD (SATA 3.0) optional

Expansion Slot

- ***NISE 3800E & NISE 3800E-H110:*** One PCIe x4 expansion slot
 - Add-on card length: 169mm max.
 - Power consumption: 10W/slot max.
- ***NISE 3800E2:*** Two PCIe x4 expansion slots
 - Add-on card length: one 169mm max, and one 240mm max.
 - Power consumption: 10W/slot max
- ***NISE 3800P2:*** Two PCI expansion slots
 - Add-on card length: one 169mm max, and one 240mm max.
 - Power consumption: 10W/slot max
- ***NISE 3800P2E:*** One PCIe x4 and one PCI expansion slot
 - Add-on card length: one 169mm max for PCIe x4, and one 240mm max for PCI
 - Power consumption: 10W/slot max
- ***NISE 3800R:*** Two 2.5" HDD expansions
- 2 x Internal mini-PCIe sockets support optional Wi-Fi/3.5G/mSATA/Fieldbus

Power Requirements

- AT/ATX power mode (default: ATX power mode)
- Power input: +9 to +30V DC
- Power adapter: Optional AC to DC power adapter (24V DC, 120W)

Dimensions

- **NISE 3800E/R & NISE 3800E-H110:** 215mm (W) x 272mm (D) x 93mm (H) (8.5" x 10.7" x 3.7")
- **NISE 3800E2/P2/P2E:** 215mm (W) x 272mm (D) x 114mm (H) (8.5" x 10.7" x 4.5")

Construction

- Aluminum and metal chassis with fanless design

Environment

- Operating Temperature:
Ambient with air flow: -5°C to 60°C, uses wide temperature memory and storage (according to IEC60068-2-1, IEC60068-2-2, IEC60068-2-14)
- Storage Temperature: -20°C to 85°C
- Relative Humidity: 10% to 93% (non-condensing)
- Shock Protection:
 - HDD: 20G, half sine, 11ms, IEC60068-27
- Vibration Protection with HDD Condition:
 - Random: 0.5Grms @ 5~500 Hz, IEC60068-2-64
 - Sinusoidal: 0.5Grms @ 5~500 Hz, IEC60068-2-6

Certifications

- CE approval- EN61000-6-2- EN61000-6-4
- FCC Class A

OS Support List

- Windows 7 32-bit and 64-bit
- Windows 8.1 32-bit and 64-bit
- Windows 10 64-bit

Weight Information

NISE 3800E/R & NISE 3800E-H110

- Gross weight: 5.9kg
- Net weight: 4.5kg

NISE 3800E2/P2/P2E

- Gross weight: 6.4kg
- Net weight: 5.0kg

Knowing Your NISE 3800 Series

NISE 3800E/E2/P2/P2E & NISE 3800R

Front Panel

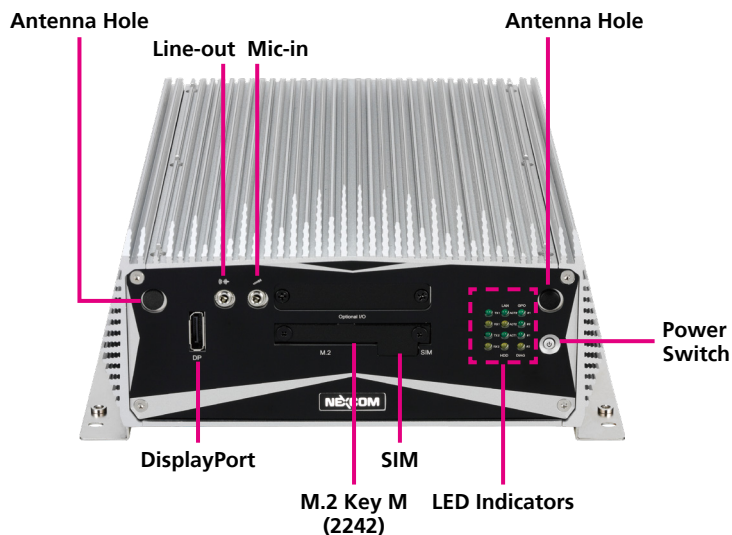

Antenna Hole

The external antenna mounting holes are used to mount and connect optional external antennas.

DisplayPort

Used to connect a DisplayPort interface monitor.

Line-out

Used to connect a headphone or a speaker.

Mic-in

Used to connect an external microphone.

M.2 Key M (2242) and SIM Card Slot

Used to install an M.2 Key M (2242) and a SIM card.

LED Indicators

Indicates the COM port, LAN and GPO activity of the system. The Diagnostics LEDs (Diag 1 and Diag 2) are used for troubleshooting system errors.

	Diag 1		Diag 2	
	Normal	Fail	Normal	Fail
Boot up	No LED light	Constant LED light		
POST	No LED light	Flashing LED light		
Memory			No LED light	Constant LED light
OS			No LED light	Flashing LED light

Power Switch

Press to power-on or power-off the system.

NISE 3800E-H110

Front Panel

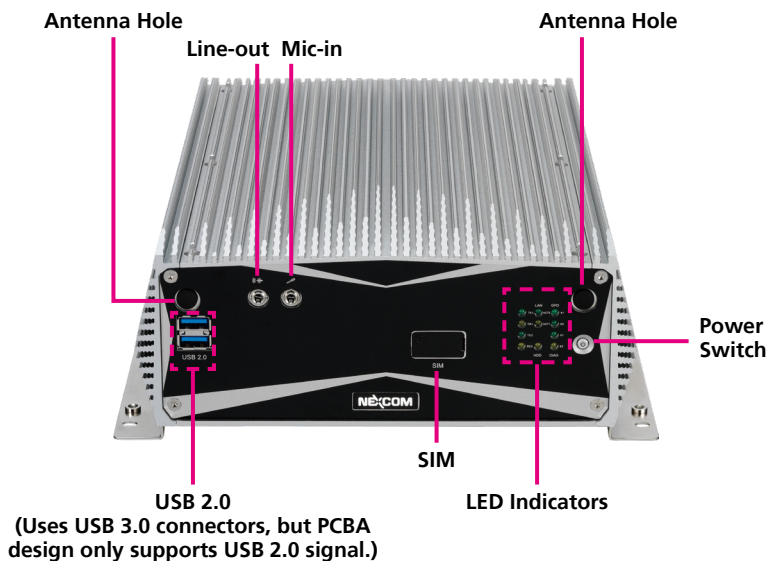

Antenna Hole

The external antenna mounting holes are used to mount and connect optional external antennas.

USB 2.0

Used to connect USB 2.0/1.1 devices. USB 3.0 connectors are used here, but only support USB 2.0 signal due to PCBA design.

Line-out

Used to connect a headphone or a speaker.

Mic-in

Used to connect an external microphone.

SIM Card Slot

Used to install a SIM card.

LED Indicators

Indicates the COM port, LAN and GPO activity of the system. The Diagnostics LEDs (Diag 1 and Diag 2) are used for troubleshooting system errors.

	Diag 1		Diag 2	
	Normal	Fail	Normal	Fail
Boot up	No LED light	Constant LED light		
POST	No LED light	Flashing LED light		
Memory			No LED light	Constant LED light
OS			No LED light	Flashing LED light

Power Switch

Press to power-on or power-off the system.

NISE 3800E & NISE 3800R

Rear Panel

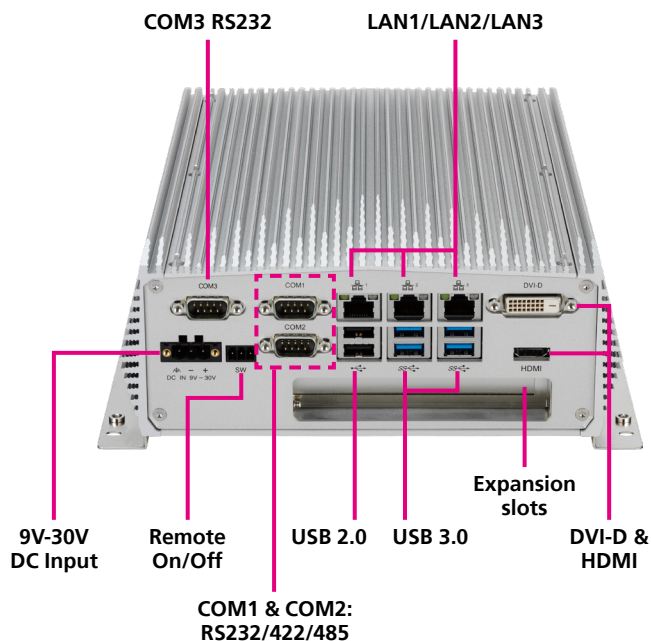

9V-30V DC Input

Used to plug a DC power cord.

Remote On/Off Switch

Used to connect a remote to power on/off the system.

COM1 & COM2

Two DB9 ports used to connect RS232/422/485 compatible devices.

COM3

One DB9 port used to connect RS232 compatible devices.

LAN1/LAN2/LAN3

Used to connect the system to a local area network.

USB 2.0

Used to connect USB 2.0/1.1 devices.

USB 3.0

Used to connect USB 3.0/2.0 devices.

DVI-D

Used to connect a DVI-D interface monitor.

HDMI

Used to connect a HDMI interface monitor.

Expansion Slots

NISE 3800E & NISE 3800E-H110: One PCIe x4 expansion slot

NISE 3800E2: Two PCIe x4 expansion slots

NISE 3800P2: Two PCI expansion slots

NISE 3800P2E: One PCIe x4 and one PCI expansion slot

NISE 3800R: Two x 2.5" HDD expansion brackets.

NISE 3800E2/P2/P2E

Rear Panel

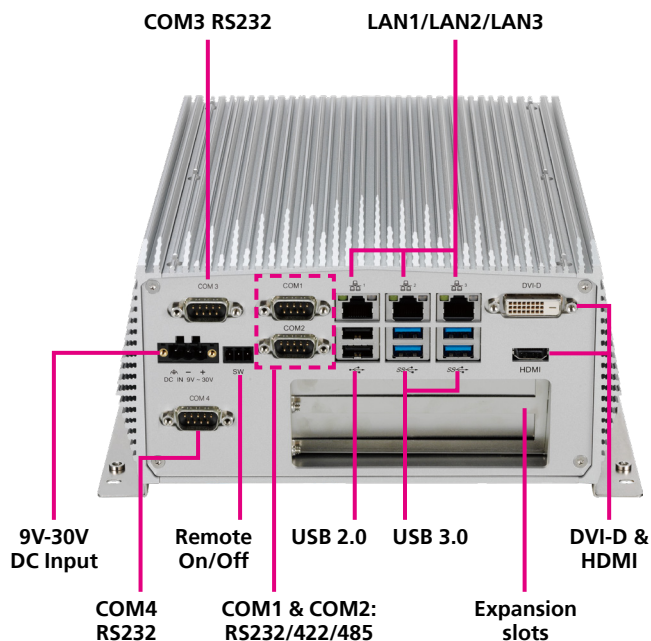

9V-30V DC Input

Used to plug a DC power cord.

Remote On/Off Switch

Used to connect a remote to power on/off the system.

COM1 & COM2

Two DB9 ports used to connect RS232/422/485 compatible devices.

COM3 & COM4

Two DB9 ports used to connect RS232 compatible devices.

LAN1/LAN2/LAN3

Used to connect the system to a local area network.

USB 2.0

Used to connect USB 2.0/1.1 devices.

USB 3.0

Used to connect USB 3.0/2.0 devices.

DVI-D

Used to connect a DVI-D interface monitor.

HDMI

Used to connect a HDMI interface monitor.

Expansion Slots

NISE 3800E & NISE 3800E-H110: One PCIe x4 expansion slot

NISE 3800E2: Two PCIe x4 expansion slots

NISE 3800P2: Two PCI expansion slots

NISE 3800P2E: One PCIe x4 and one PCI expansion slot

NISE 3800R: Two x 2.5" HDD expansion brackets.

NISE 3800E-H110

Rear Panel

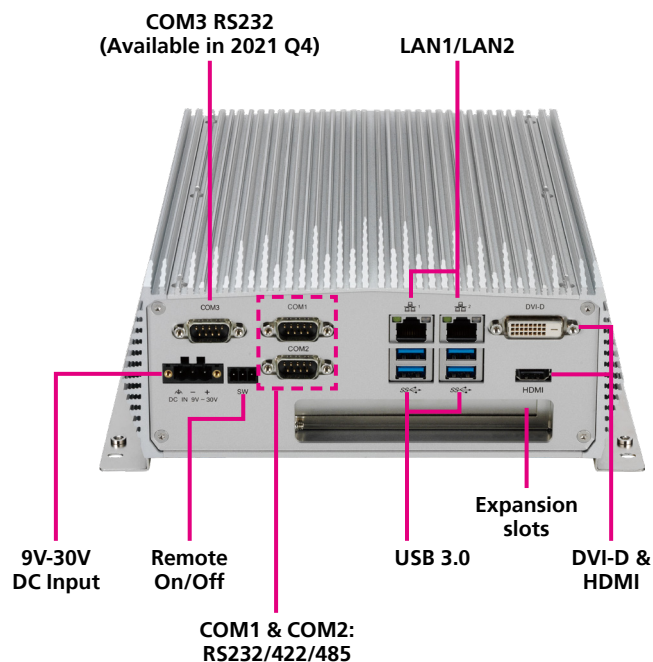

9V-30V DC Input

Used to plug a DC power cord.

Remote On/Off Switch

Used to connect a remote to power on/off the system.

COM1 & COM2

Two DB9 ports used to connect RS232/422/485 compatible devices.

COM3 (Available in 2021 Q4)

One DB9 port used to connect RS232 compatible devices.

Note: NISE 3800E-H110's COM 3 port to be added by 2021 Q4 (by running change), please consult with your NexAloT sales for further information.

LAN1/LAN2

Used to connect the system to a local area network.

USB 3.0

Used to connect USB 3.0/2.0 devices.

DVI-D

Used to connect a DVI-D interface monitor.

HDMI

Used to connect a HDMI interface monitor.

Expansion Slots

NISE 3800E & NISE 3800E-H110: One PCIe x4 expansion slot
 NISE 3800E2: Two PCIe x4 expansion slots
 NISE 3800P2: Two PCI expansion slots
 NISE 3800P2E: One PCIe x4 and one PCI expansion slot
 NISE 3800R: Two x 2.5" HDD expansion brackets.

Mechanical Dimensions

NISE 3800E

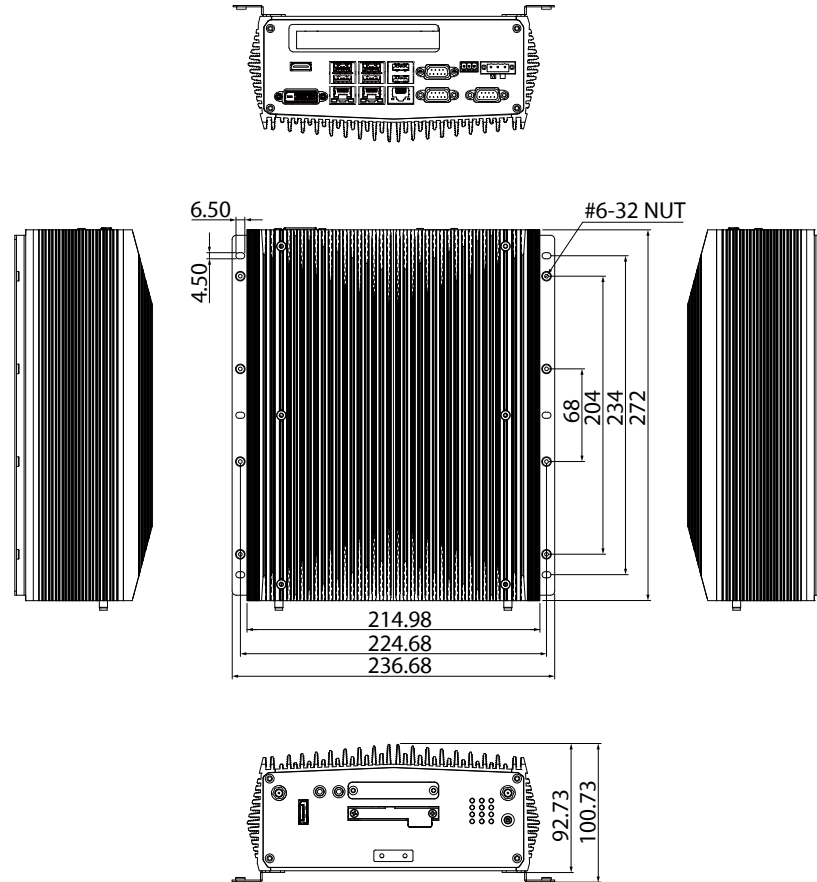

NISE 3800E2/NISE 3800P2/NISE 3800P2E

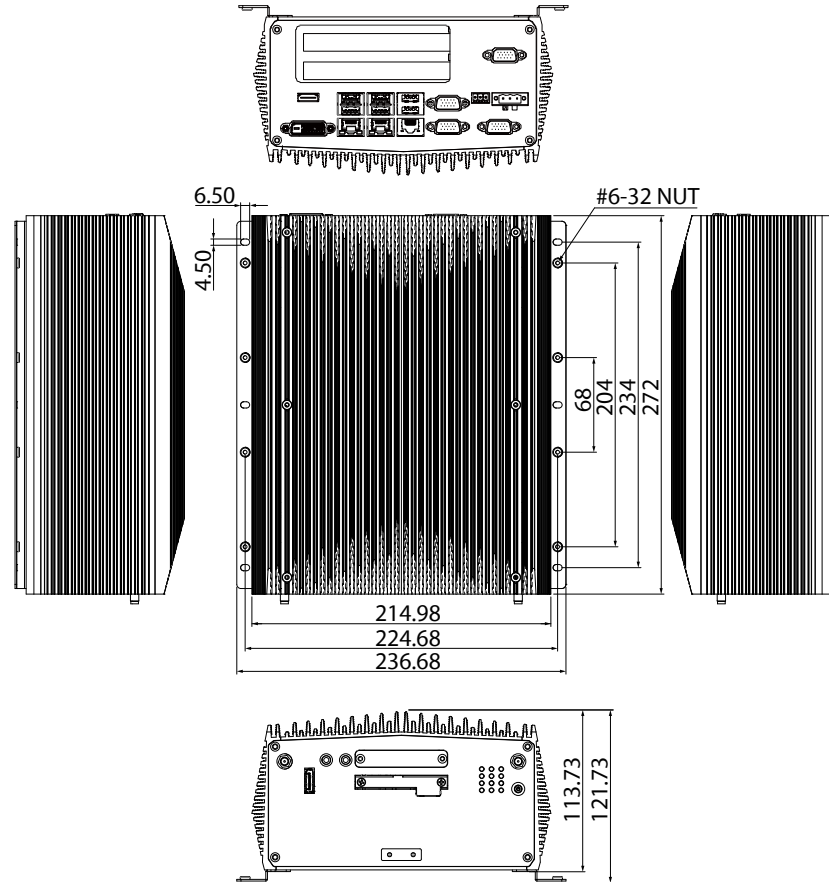

NISE 3800E-H110

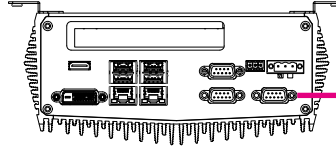

Note: NISE 3800E-H110's COM 3 port to be added by 2021 Q4 (by running change), please consult with your NexAloT sales for further information.

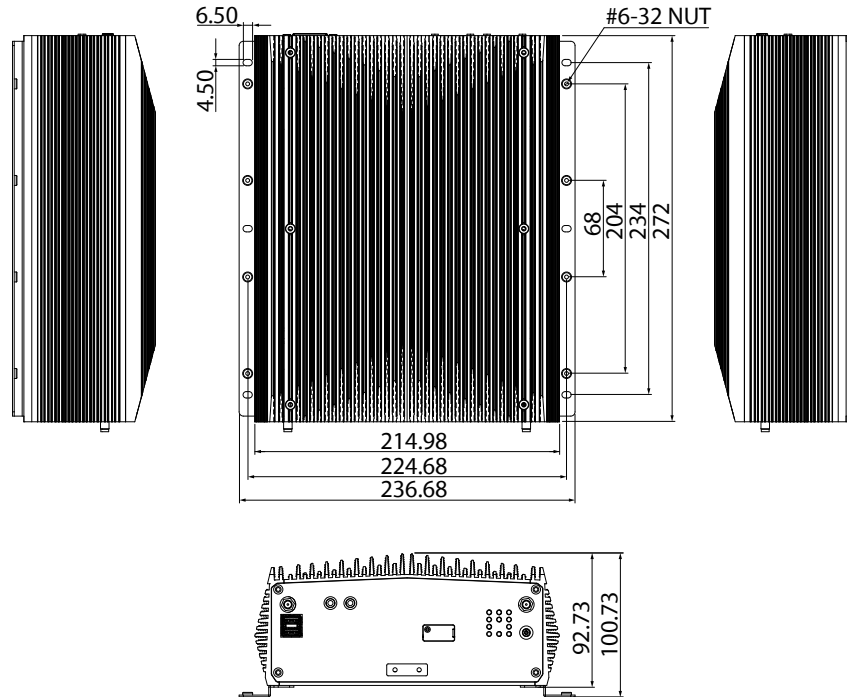

NISE 3800R

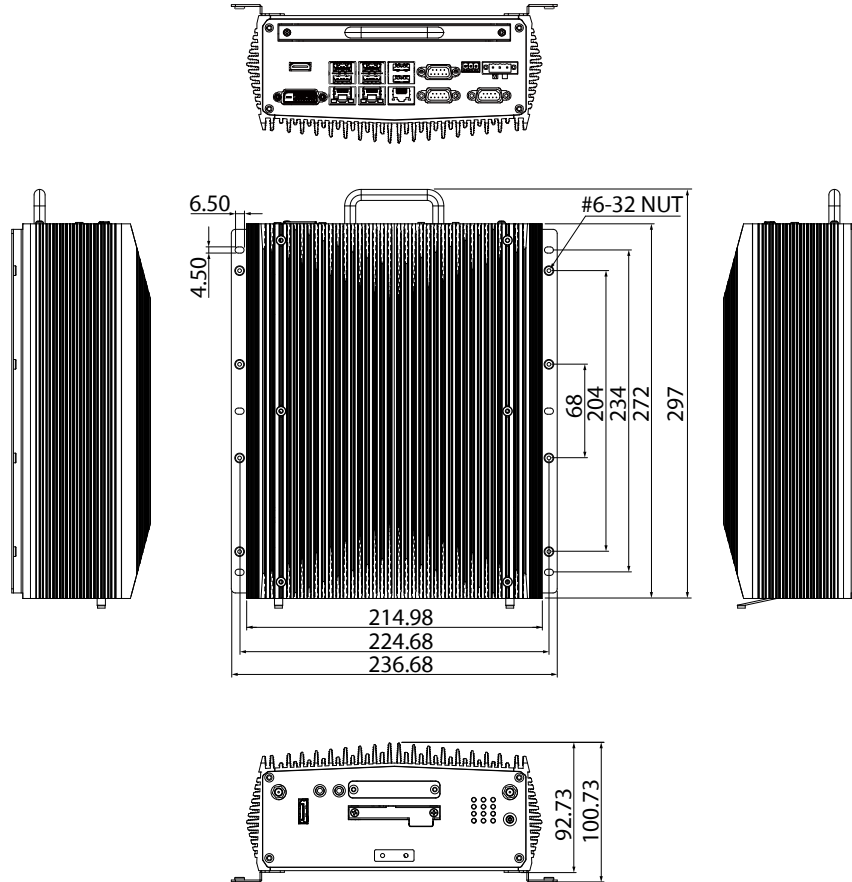

CHAPTER 2: JUMPERS AND CONNECTORS

This chapter describes how to set the jumpers and connectors on the NISE 3800 series motherboard.

Before You Begin

- Ensure you have a stable, clean working environment. Dust and dirt can get into components and cause a malfunction. Use containers to keep small components separated.
- Adequate lighting and proper tools can prevent you from accidentally damaging the internal components. Most of the procedures that follow require only a few simple tools, including the following:
 - A Philips screwdriver
 - A flat-tipped screwdriver
 - A set of jewelers screwdrivers
 - A grounding strap
 - An anti-static pad
- Using your fingers can disconnect most of the connections. It is recommended that you do not use needle-nosed pliers to disconnect connections as these can damage the soft metal or plastic parts of the connectors.
- Before working on internal components, make sure that the power is off. Ground yourself before touching any internal components, by touching a metal object. Static electricity can damage many of the electronic components. Humid environments tend to have less static electricity than

dry environments. A grounding strap is warranted whenever danger of static electricity exists.

Precautions

Computer components and electronic circuit boards can be damaged by discharges of static electricity. Working on computers that are still connected to a power supply can be extremely dangerous.

Follow the guidelines below to avoid damage to your computer or yourself:

- Always disconnect the unit from the power outlet whenever you are working inside the case.
- If possible, wear a grounded wrist strap when you are working inside the computer case. Alternatively, discharge any static electricity by touching the bare metal chassis of the unit case, or the bare metal body of any other grounded appliance.
- Hold electronic circuit boards by the edges only. Do not touch the components on the board unless it is necessary to do so. Don't flex or stress the circuit board.
- Leave all components inside the static-proof packaging that they shipped with until they are ready for installation.
- Use correct screws and do not over tighten screws.

Chassis Ground Isolation

Before working with the system, follow the instructions below to ensure the chassis is grounded:

1. Attach a cable lug on the protective conductor screw.
2. Connect the protective conductor screw to a protective grounding connection in your installation site.

The protective conductor screw (round head screw) is located on the bottom left corner of the rear panel as shown below.



Specification of the round head screw:
Round Head Screw Long Fei: p6#32T Nylok P6#32T Outer Teeth
Washer Nylok

Functional Ground Isolation

When connecting power to the terminal block connector on the system, ensure the ground pin (marked in red below) on the connector is connected to a grounding stripe.

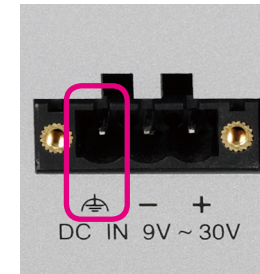

Jumper Settings

A jumper is the simplest kind of electric switch. It consists of two metal pins and a cap. When setting the jumpers, ensure that the jumper caps are placed on the correct pins. When the jumper cap is placed on both pins, the jumper is short. If you remove the jumper cap, or place the jumper cap on just one pin, the jumper is open.

Refer to the illustrations below for examples of what the 2-pin and 3-pin jumpers look like when they are short (on) and open (off).

Two-Pin Jumpers: Open (Left) and Short (Right)

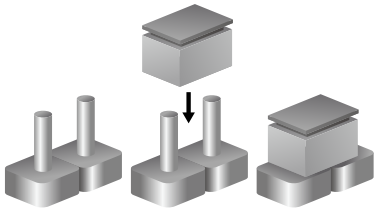

Three-Pin Jumpers: Pins 1 and 2 are Short

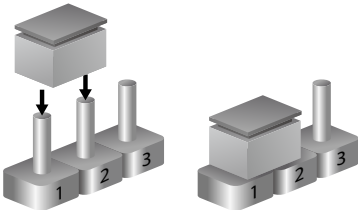

The figure below is the bottom view of the main board.

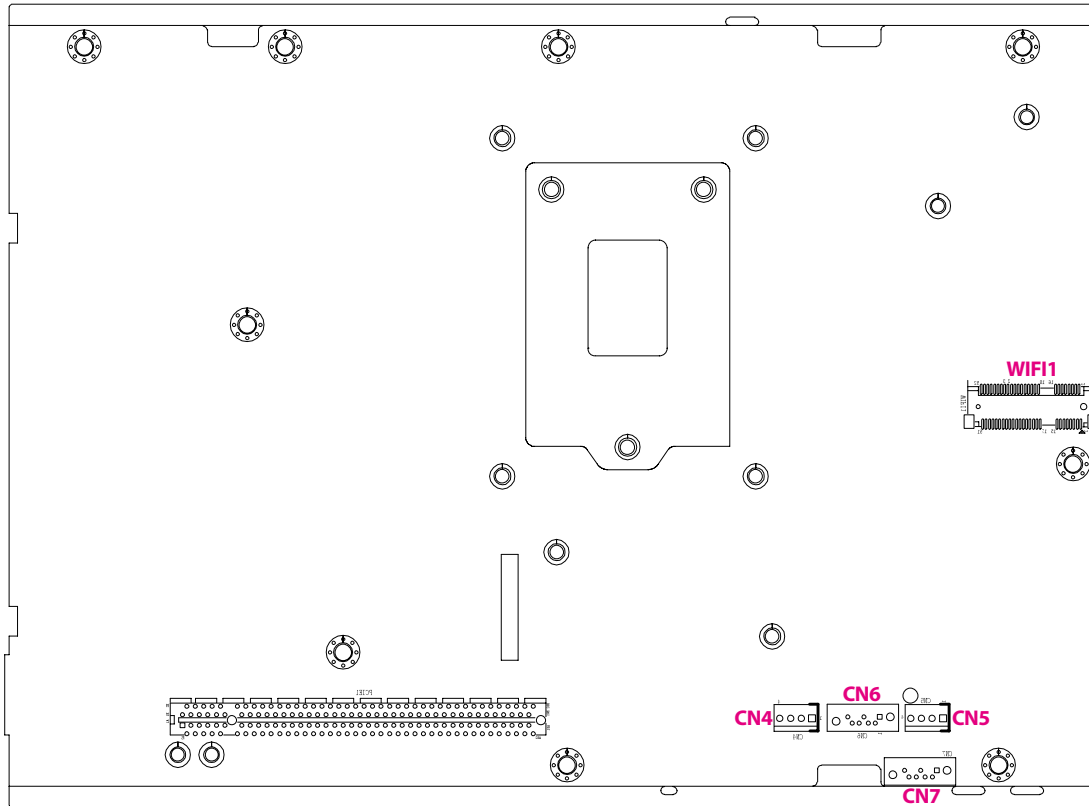

Locations of the Jumpers and Connectors for NISE 3800E-H110

The figure below is the top view of the main board used in NISE 3800E-H110. It shows the locations of the jumpers and connectors.

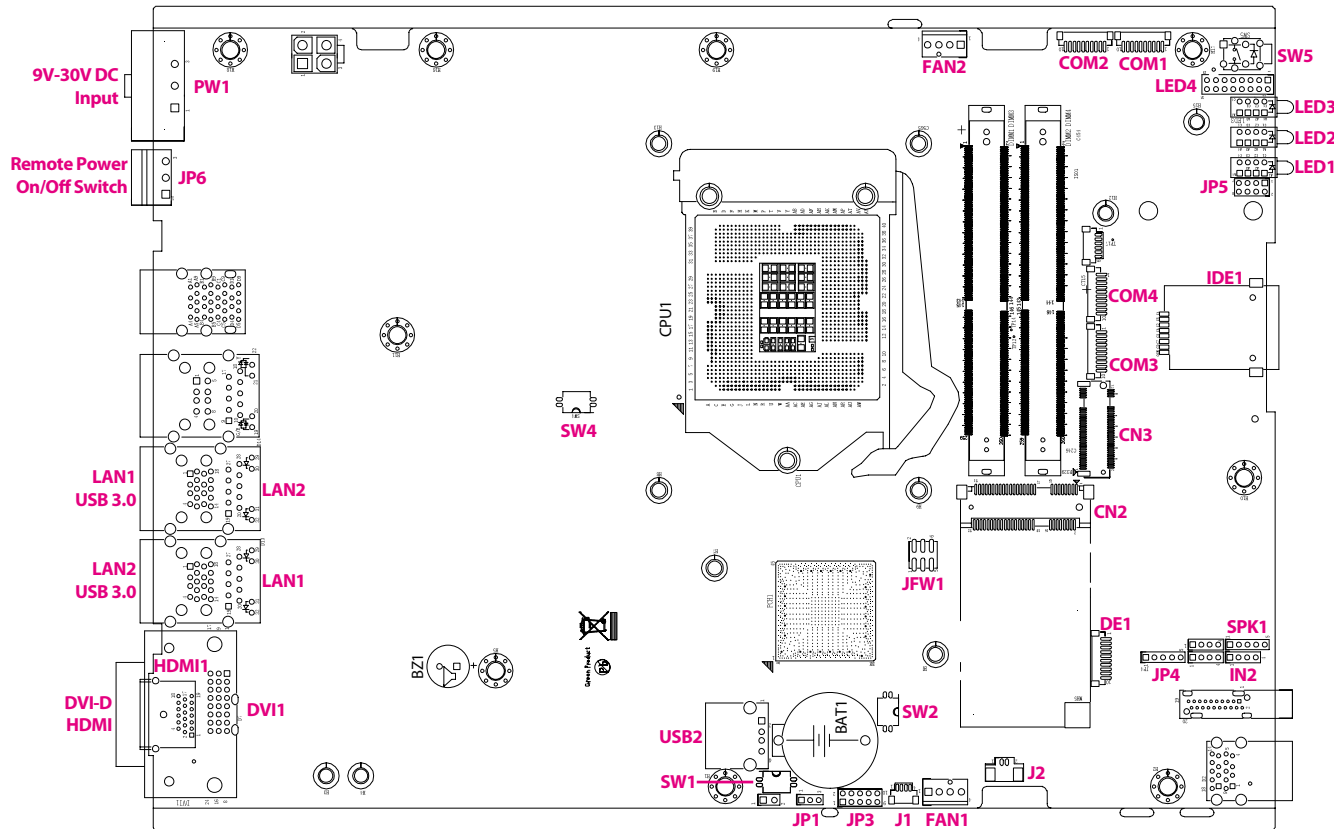

The figure below is the bottom view of the main board.

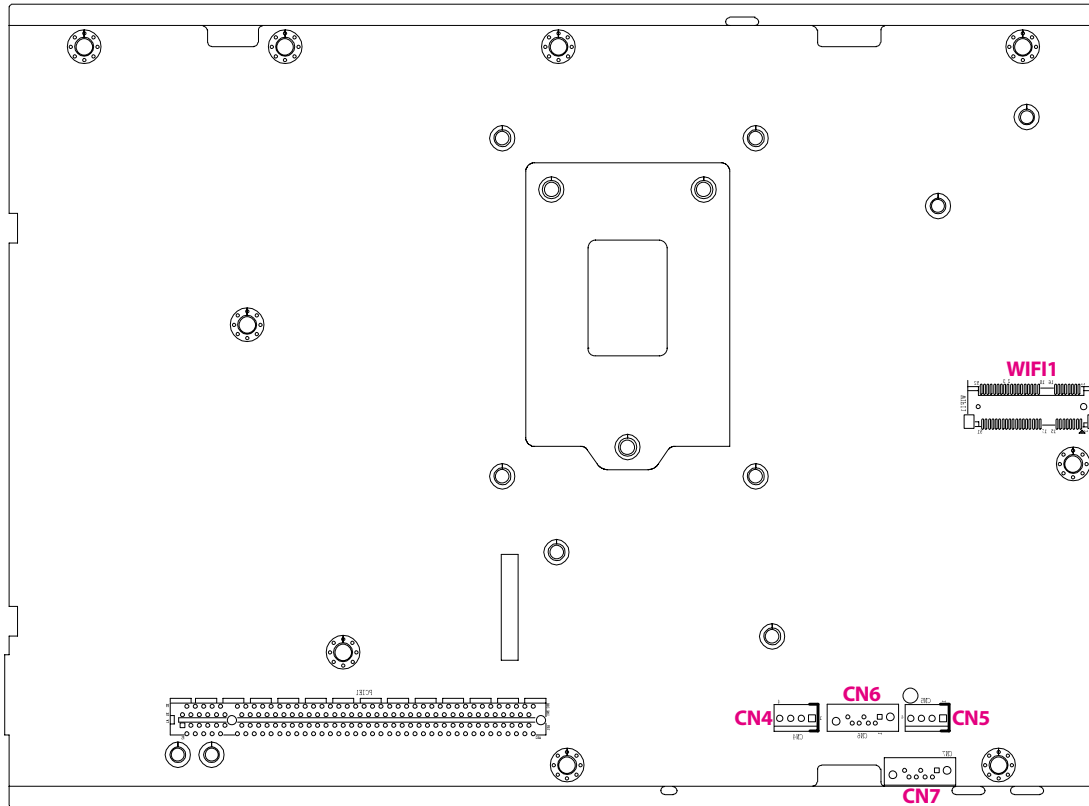

Jumpers and DIP Switch Settings

AT/ATX Power Select

Connector type: 2-pin On/Off DIP switch

Connector location: SW2

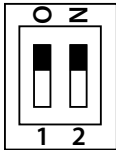

Pin	Settings
1	PCH_PWRBT_N
2	NC
3	NC
4	ATB

PCI Express* Bifurcation

Connector type: 2-pin On/Off DIP switch

Connector location: SW4

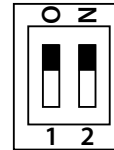

Pin	Settings
1	CPU_CFG6
2	CPU_CFG5
3	GND
4	GND

Clear CMOS Select

Connector type: 2-pin On/Off DIP switch
Connector location: SW1

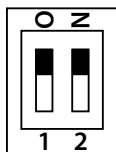

Pin	Settings
1	VCCRTC*
2	SRTC_RST#*
3	GND
4	GND

COM3 RS232 RI# Power Select

Connector type: 1x5 5-pin header, 2.0mm pitch
Connector location: JP4

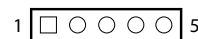

Pin	Definition	Pin	Definition
1	VCC5	2	COM_ISOR3#_T
3	VCC12	4	COM_ISOR3#_T
5	COM_RI#3		

Connector Pin Definitions

External I/O Interfaces - Front Panel

Power Button

Connector location: SW5



Pin	Definition	Pin	Definition
1	GND	2	H_PWRBTN#_M
3	H_PWRBTN#_M	4	GND
A1	PWR_SW_P	C1	PWR_SW_N
MH1	NC	MH2	NC

LED Indicators

Connector location: LED1, LED2 and LED3

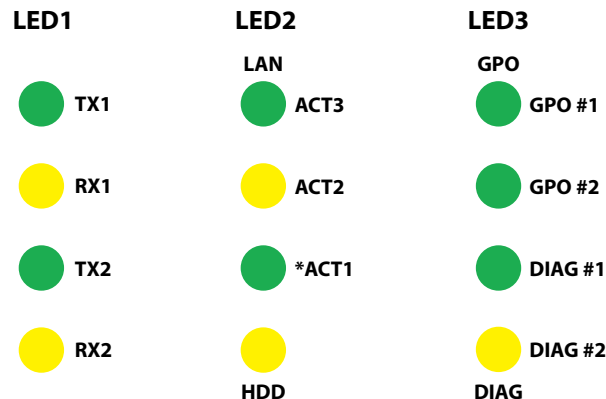

	Pin	Definition	Pin	Definition
LED1	A1	VCC3	C1	COM2_RXLEDN
	A2	VCC3	C2	COM2_TXLEDN
	A3	NETX100_RUN	C3	COM1_RXLEDN
	A4	VCC3	C4	COM1_TXLEDN
LED2	A1	VCC3	C1	SATALED#
	A2	VCC3	C2	LAN3_ACT#_LED
	A3	NETX100_RUN	C3	LAN2_ACT#_LED
	A4	VCC3	C4	LAN1_ACT#_LED
LED3	A1	VCC3	C1	DIAG2_C
	A2	VCC3	C2	DIAG1_C
	A3	NETX100_RUN	C3	SIO_GP15_66
	A4	VCC3	C4	SIO_GP16_67

***Note:** The LEDs shown above are for NISE 3800E/E2/P2/P2E & NISE 3800R. The NISE 3800E-H110 model features two LAN ports and two respective LED indicators on the front panel.

SIM Card Socket

Connector location: IDE1

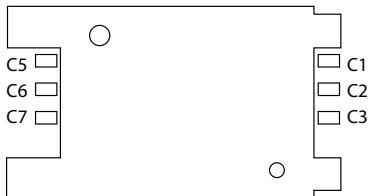

Pin	Definition	Pin	Definition
C1	UIM_PWR	C2	UIM_RESET
C3	UIM_SIM_CLK	C5	GND
C6	UIM_VPP	C7	UIM_DATA
MH1	GND	MH2	GND

DisplayPort

(NISE 3800E/E2/P2/P2E & NISE 3800R Only)

Connector type: DisplayPort

Connector location: CN1

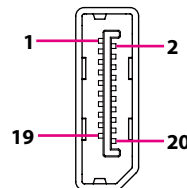

Pin	Definition	Pin	Definition
1	HDMI2_DATA0_P	2	GND
3	HDMI2_DATA0_N	4	HDMI2_DATA1_P
5	GND	6	HDMI2_DATA1_N
7	HDMI2_DATA2_P	8	GND
9	HDMI2_DATA2_N	10	HDMI2_CLK_P
11	GND	12	HDMI2_CLK_N
13	DPC_CONFIG1	14	DPC_CONFIG2
15	DPC_AUXP_C	16	GND
17	DPC_AUXN_C	18	DPD_HPD_C
19	GND	20	DP_PWR_C

External I/O Interfaces - Rear Panel

9V - 30V DC Power Input

Connector type: Phoenix Contact 1x3 3-pin terminal block

Connector location: PW1

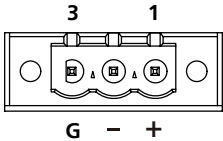

Pin	Definition
1	VIN_1
2	VIN_VSS
3	Chassis_GND

Remote Power On/Off & S3 Connector

Connector type: 3-pin switch

Connector location: JP6

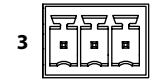

Pin	Definition
1	PWRBTN#_J
2	GND
3	SLP_S3#_C

LAN3 and USB 3.0 Ports

Connector type: RJ45 port with LEDs

Dual USB 3.0 ports, Type A

Connector location: LAN1A (USB) and LAN1B (LAN)

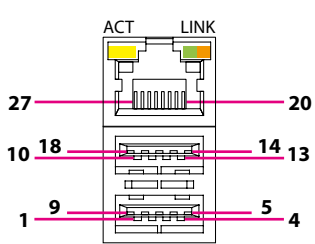

Act	Status
Flashing Yellow	Data activity
Off	No activity

Link	Status
Steady Green	1G network link
Steady Orange	100Mbps network link
Off	No link

Pin	Definition	Pin	Definition
1	P5V_USB_P01	2	USB2N0_C
3	USB2P0_C	4	GND
5	USB3RN1_C	6	USB3RP1_C
7	GND	8	USB3TN1_C
9	USB3TP1_C	10	P5V_USB_P01
11	USB2N1_C	12	USB2P1_C
13	GND	14	USB3RN2_C
15	USB3RP2_C	16	GND

Pin	Definition	Pin	Definition
17	USB3TN2_C	18	USB3TP2_C
19	LAN1_VCC	20	LAN1_MDI0P
21	LAN1_MDI0N	22	LAN1_MDI1P
23	LAN1_MDI1N	24	LAN1_MDI2P
25	LAN1_MDI2N	26	LAN1_MDI3P
27	LAN1_MDI3N	28	GND
29	LAN1_ACTPW	30	LAN1_ACT#_LED
31	LAN1_LINK100#_LED	32	LAN1_LINK

LAN2 and USB 3.0 Ports

Connector type: RJ45 port with LEDs

Dual USB 3.0 ports, Type A

Connector location: LAN2A (USB) and LAN2B (LAN)

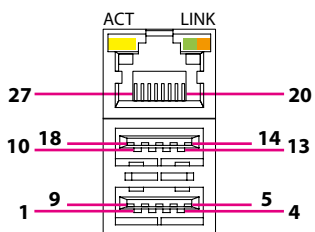

Act	Status
Flashing Yellow	Data activity
Off	No activity

Link	Status
Steady Green	1G network link
Steady Orange	100Mbps network link
Off	No link

Pin	Definition	Pin	Definition
1	P5V_USB_P23	2	USB2N2_C
3	USB2P2_C	4	GND
5	USB3RN3_C	6	USB3RP3_C
7	GND	8	USB3TN3_C
9	USB3TP3_C	10	P5V_USB_P23
11	USB2N3_C	12	USB2P3_C
13	GND	14	USB3RN4_C
15	USB3RP4_C	16	GND

Pin	Definition	Pin	Definition
17	USB3TN4_C	18	USB3TP4_C
19	LAN2_VCC	20	LAN2_MDI0P
21	LAN2_MDI0N	22	LAN2_MDI1P
23	LAN2_MDI1N	24	LAN2_MDI2P
25	LAN2_MDI2N	26	LAN2_MDI3P
27	LAN2_MDI3N	28	GND
29	LAN2_ACTPW	30	LAN2_ACT#_LED
31	LAN2_LINK100#_LED	32	LAN2_LINK

LAN1 and USB 2.0 Ports

(NISE 3800E/E2/P2/P2E & NISE 3800R Only)

Connector type: RJ45 port with LEDs

Dual USB 2.0 ports, Type A

Connector location: LAN3A (USB) and LAN3B (LAN)

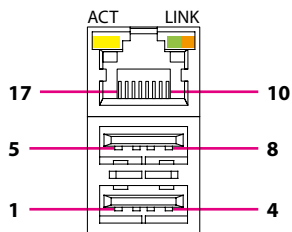

Act	Status
Flashing Yellow	Data activity
Off	No activity

Link	Status
Steady Green	1G network link
Steady Orange	100Mbps network link
Off	No link

Pin	Definition	Pin	Definition
1	P5V_USB_P45	2	USB2N4_C
3	USB2P4_C	4	GND
5	P5V_USB_P45	6	USB2N5_C
7	USB2P5_C	8	GND
9	LAN3_VCC	10	LAN3_MDI0P
11	LAN3_MDI0N	12	LAN3_MDI1P
13	LAN3_MDI1N	14	LAN3_MDI2P
15	LAN3_MDI2N	16	LAN3_MDI3P
17	LAN3_MDI3N	18	GND
19	LAN3_LINK	20	LAN3_LINK100#_LED
21	LAN3_ACT#_LED	22	LAN3_LED_P

DVI-D Connector

Connector type: 24-pin D-Sub, 2.0mm-M-180 (DVI)

Connector location: DVI1

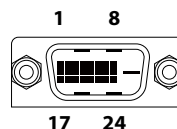

Pin	Definition	Pin	Definition
1	DVI1_DATA2_N_C	2	DVI1_DATA2_P_C
3	GND	4	NC
5	NC	6	DVI1_CTRL_CLK_C
7	DVI1_CTRL_DAT_C	8	NC
9	DVI1_DATA1_N_C	10	DVI1_DATA1_P_C
11	GND	12	NC
13	NC	14	DVI1_PWR_C
15	GND	16	DVI1_HPD_C
17	DVI1_DATA0_N_C	18	DVI1_DATA0_P_C
19	GND	20	NC
21	NC	22	GND
23	DVI1_CLK_P_C	24	DVI1_CLK_N_C

HDMI

Connector type: HDMI port

Connector location: HDMI1

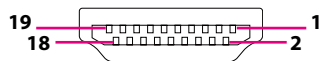

Pin	Definition	Pin	Definition
1	HDMI_DATA2_P_C	2	GND
3	HDMI_DATA2_N_C	4	HDMI_DATA1_P_C
5	GND	6	HDMI_DATA1_N_C
7	HDMI_DATA0_P_C	8	GND
9	HDMI_DATA0_N_C	10	GND
11	GND	12	HDMI_CLK_N_C
13	NC	14	NC
15	HDMI_CLK	16	HDMI_DAT
17	GND	18	HDMI_PWR_C
19	HDMI_HPD_C		

Internal Connectors

Reset Connector

Connector type: 1x2 2-pin Wafer, 1.25mm pitch

Connector location: J2

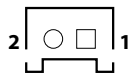

Pin	Definition
1	PM_RESET#_J
2	GND
MH1	GND
MH2	GND

FW BIOS Connector

Connector type: 2x3 6-pin header, 2.0mm pitch

Connector location: JFW1

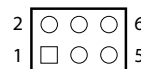

Pin	Definition	Pin	Definition
1	VCCSPI	2	GND
3	BIOS_CS0#	4	BIOS_SCK
5	BIOS_SO	6	BIOS_SI

SMBus

Connector type: 1x3 3-pin header, 2.0mm pitch

Connector location: JP1

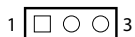

Pin	Definition
1	SMB_CLK
2	SMB_DAT
3	GND

SATA Power Connectors

Connector type: 1x4 4-pin Wafer, 2.54mm pitch

Connector location: CN4 and CN5

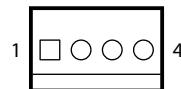

Pin	Definition
1	VCC12
2	GND
3	GND
4	VCC5

SATA Connectors

Connector type: Standard Serial ATA 7P (1.27mm, SATA-M-180)

Connector location: CN6 & CN7

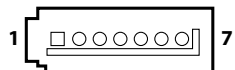

Pin	Definition	Pin	Definition
1	GND	2	SATA_TXP0_C
3	SATA_TXN0_C	4	GND
5	SATA_RXN0_C	6	SATA_RXP0_C
7	GND		

Line-in Pin Header

Connector type: 1x4 4-pin header, 2.0mm pitch

Connector location: IN2

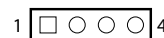

Pin	Definition
1	LINE1-L1
2	AGND
3	LINEIN_JD
4	LINE1-R1

Speaker-out Pin Header

Connector type: 1x5 5-pin header, 2.0mm pitch

Connector location: SPK1

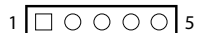

Pin	Definition	Pin	Definition
1	OUT-LR+_C	2	OUT-LR-_C
3	AGND	4	OUT-RR+_C
5	OUT-RR-_C		

Debug Connector

Connector type: 1x10 10-pin header, 1.0mm pitch

Connector location: DE1



Pin	Definition	Pin	Definition
1	GND	2	RST_SIO_N
3	CLK_PCI_P80	4	LPC_FRAME#
5	LPC_AD3	6	LPC_AD2
7	LPC_AD1	8	LPC_AD0
9	INT_SERIRQ_C	10	VCC3

COM Port 1 Connector

Connector type: 1x10 10-pin header, 1.0mm pitch

Connector location: COM1

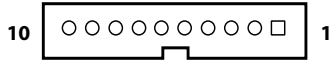

Pin	Definition	Pin	Definition
1	COM_ISODCD#1	2	COM_ISORXD1
3	COM_ISOTXD1	4	COM_ISODTR#1
5	ISO_GND	6	COM_ISODSR#1
7	COM_ISORTS#1	8	COM_ISOCTS#1
9	COM_ISORI#1	10	ISO_GND

COM Port 2 Connector

Connector type: 1x10 10-pin header, 1.0mm pitch

Connector location: COM2

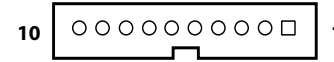

Pin	Definition	Pin	Definition
1	COM_ISODCD#2	2	COM_ISORXD2
3	COM_ISOTXD2	4	COM_ISODTR#2
5	ISO_GND	6	COM_ISODSR#2
7	COM_ISORTS#2	8	COM_ISOCTS#2
9	COM_ISORI#2	10	ISO_GND

COM Port 3 Connector

Connector type: 1x10 10-pin header, 1.0mm pitch

Connector location: COM3

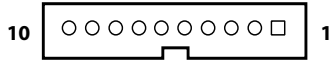

Pin	Definition	Pin	Definition
1	COM_DCD#3_C	2	COM_RXD3_C
3	COM_TXD3_C	4	COM_DTR#3_C
5	GND	6	COM_DSR#3_C
7	COM_RTS#3_C	8	COM_CTS#3_C
9	COM_ISOR3#_C	10	GND

COM Port 4 Connector

Connector type: 1x10 10-pin header, 1.0mm pitch

Connector location: COM4

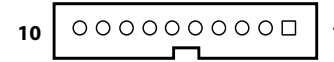

Pin	Definition	Pin	Definition
1	COM_DCD#4_C	2	COM_RXD4_C
3	COM_TXD4_C	4	COM_DTR#4_C
5	GND	6	COM_DSR#4_C
7	COM_RTS#4_C	8	COM_CTS#4_C
9	COM_ISOR4#_C	10	GND

GPIO Pin Header

Connector type: 2x5 10-pin header, 2.0mm pitch
Connector location: JP3

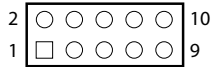

Pin	Definition	Pin	Definition
1	GPIO_PWR	2	GPIO_GND
3	GPIO80	4	GPIO84
5	GPIO81	6	GPIO85
7	GPIO82	8	GPIO86
9	GPIO83	10	GPIO87

Fan1 Connector

Connector type: 1x4 4-pin Wafer, 2.54mm pitch
Connector location: FAN1

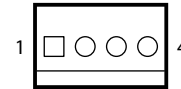

Pin	Definition
1	GND
2	FAN1_12V_C
3	FAN_TAC1_C
4	FAN_CTL1_C

Fan2 Connector

Connector type: 1x4 4-pin Wafer, 2.54mm pitch
Connector location: FAN2

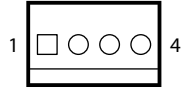

Pin	Definition
1	GND
2	FAN1_12V_2_C
3	FAN_TAC2_C
4	FAN_CTL2_C

USB 2.0 Connector

Connector type: USB Port
Connector location: USB2

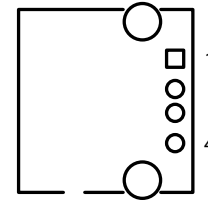

Pin	Definition
1	P5V_USB_P8
2	USB2N8_C
3	USB2P8_C
4	GND

LED Pin Header

Connector type: 2x8 16-pin header, 2.0mm pitch
Connector location: LED4

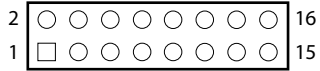

Pin	Definition	Pin	Definition
1	TX1_P	2	COM1_TXLEDN
3	RX1_P	4	COM1_RXLEDN
5	TX2_P	6	COM2_TXLEDN
7	RX2_P	8	COM2_RXLEDN
9	LAN1_ACT#_LED_P	10	LAN1_ACT#_LED
11	LAN2_ACT#_LED_P	12	LAN2_ACT#_LED
13	LAN3_ACT#_LED_P	14	LAN3_ACT#_LED
15	CFAST_DET_P	16	CFAST_DET
17	SIO_GP54_64_P	18	SIO_GP54_64
19	SIO_GP55_65_P	20	SIO_GP55_65
21	SIO_GP56_66_P	22	SIO_GP56_66
23	SATALED#_P	24	SATALED#

LED Pin Header

Connector type: 2x4 8-pin header, 2.0mm pitch
Connector location: JP5

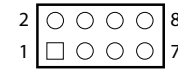

Pin	Definition	Pin	Definition
1	DIAG1_P	2	DIAG1_C
3	DIAG2_P	4	DIAG2_C
5	SIO_GP16_67_P	6	SIO_GP16_67
7	SIO_GP15_66_P	8	SIO_GP15_66

MCU Connector

Connector type: 1x4 4-pin header, 1.0mm pitch

Connector location: J1



Pin	Definition
1	3VSB
2	SBW_TCK
3	SBW_TDIO
4	GND

Mini-PCle

Connector location: CN2

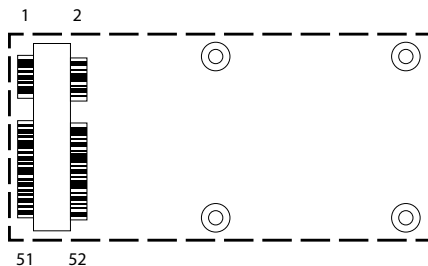

Pin	Definition	Pin	Definition
1	WAKE_N	2	3VSB_MINI2
3	NC	4	GND
5	NC	6	1V5_MINI2
7	MINICARD2CLKREQ#	8	NC
9	GND	10	NC
11	CLK_MINI_N_C	12	NC
13	CLK_MINI_P_C	14	NC
15	GND	16	NC
17	NC	18	GND
19	NC	20	MINICARD2DIS#
21	GND	22	RST_MINIPCIE2
23	PCIE_mSATA_RXP_C_C	24	3VSB_MINI2
25	PCIE_mSATA_RXN_C	26	GND

Pin	Definition	Pin	Definition
27	GND	28	1V5_MINI2
29	GND	30	MINI1_CLK
31	PCIE_mSATA_TXN_C	32	MINI1_DAT
33	PCIE_mSATA_TXP_C	34	GND
35	GND	36	NC
37	GND	38	NC
39	3VSB_MINI2	40	GND
41	3VSB_MINI2	42	NC
43	GND	44	NC
45	NC	46	NC
47	NC	48	1V5_MINI2
49	NC	50	GND
51	PCIE_mSATA_SEL_51	52	3VSB_MINI2

Mini-PCIe Connector

Connector location: WIFI1

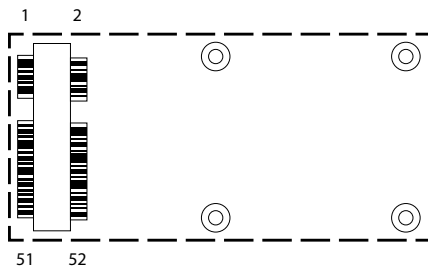

Pin	Definition	Pin	Definition
1	WAKE_N	2	3VSB_MINI1
3	NC	4	GND
5	NC	6	1V5_MINI1
7	MINICARD1CLKREQ#	8	UIM_PWR
9	GND	10	UIM_DATA
11	CLK_WIFI_N_C	12	UIM_CLK
13	CLK_WIFI_P_C	14	UIM_RESET
15	GND	16	UIM_VPP
17	NC	18	GND
19	NC	20	MINICARD1DIS#
21	GND	22	RST_MINIPCI1
23	PCIE_RN4_WIFI_C	24	3VSB_MINI1
25	PCIE_RP4_WIFI_C	26	GND

Pin	Definition	Pin	Definition
27	GND	28	1V5_MINI1
29	GND	30	WIFI1_CLK
31	PCH_WIFI_TXN4	32	WIFI1_DAT
33	PCH_WIFI_TXP4	34	GND
35	GND	36	USB2N6_C
37	GND	38	USB2P6_C
39	3VSB_MINI1	40	GND
41	3VSB_MINI1	42	NC
43	GND	44	NC
45	CL_CLK_C	46	NC
47	CL_DAT_C	48	1V5_MINI1
49	CL_RST#_C	50	GND
51	NC	52	3VSB_MINI1

NGFF (M.2 Key M [2242]) Connector (SATA/PCIe x4)

Connector location: CN3

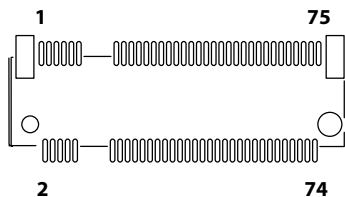

Pin	Definition	Pin	Definition
1	GND	2	3VSB
3	GND	4	3VSB
5	PCIE_RN20_M	6	NC
7	PCIE_RP20_M	8	NC
9	GND	10	NC
11	PCIE_TN20_M_C	12	3VSB
13	PCIE_TP20_M_C	14	3VSB
15	GND	16	3VSB
17	PCIE_RN19_M	18	3VSB
19	PCIE_RP19_M	20	NC
21	GND	22	NC
23	PCIE_TN19_M_C	24	NC
25	PCIE_TP19_M_C	26	NC
27	GND	28	NC
29	PCIE_RN18_M	30	NC
31	PCIE_RP18_M	32	NC
33	GND	34	NC
35	PCIE_TN18_M_C	36	NC
37	PCIE_TP18_M_C	38	NC

Pin	Definition	Pin	Definition
39	GND	40	NC
41	PCIE_RP17_M	42	NC
43	PCIE_RN17_M	44	NC
45	GND	46	NC
47	PCIE_TN17_M_C	48	NC
49	PCIE_TP17_M_C	50	RST_M2_N
51	GND	52	PCIECLKRQ7#
53	CLK_PCIE_M_N	54	WAKE_N
55	CLK_PCIE_M_P	56	NC
57	GND	58	NC
59		60	
61		62	
63		64	
65		66	
67		68	SUS_CLK
69	SATA_PCIE_SEL	70	
71	GND	72	3VSB
73	GND	74	3VSB
75	GND		

CHAPTER 3: SYSTEM SETUP

Removing the Top Cover



Prior to removing the chassis cover, make sure the unit's power is off and disconnected from the power sources to prevent electric shock or system damage.

1. Locate the 6 screws on the top cover.

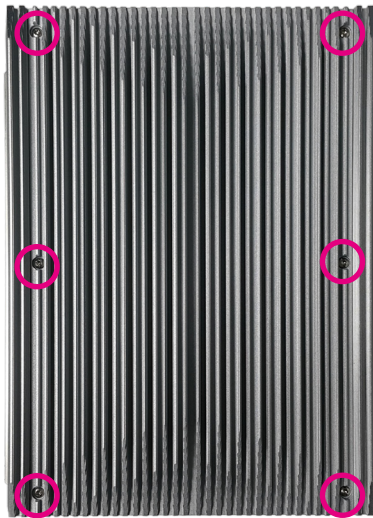

2. Remove the screws then lift up the cover and remove it from the chassis.

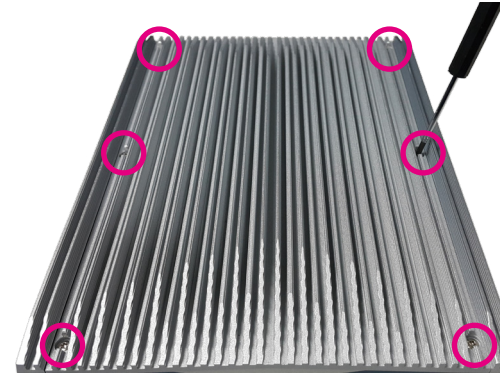

Wallmount Brackets

The wallmount brackets provide a convenient and economical way of mounting the system on the wall.

1. The mounting holes are located at the bottom of the system. Secure the brackets on each side of the system using the provided mounting screws.
2. Secure the brackets to the system by inserting four retention screws (M6*10mm) into each bracket.

Secure the bracket to the system

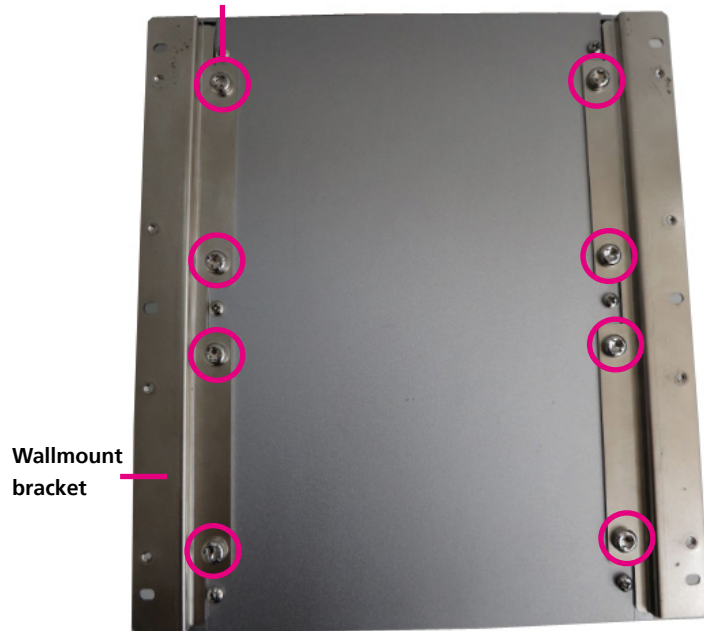

3. Now mount the system on the wall by fastening screws through the bracket's mounting holes.

Fasten screws to mount the system to the wall



Removing the Bottom Cover

1. Locate the 6 screws on the bottom cover.

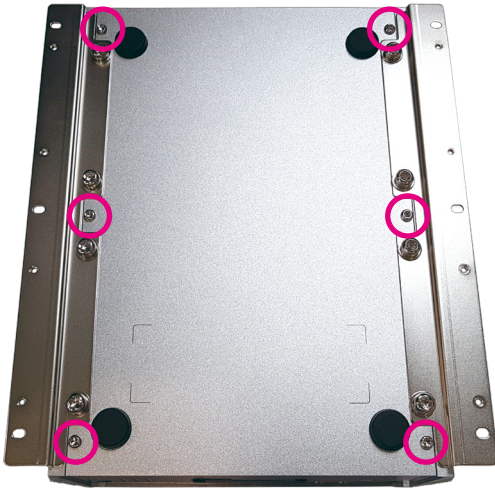

2. Remove the screws then lift up the bottom cover and remove it from the chassis.

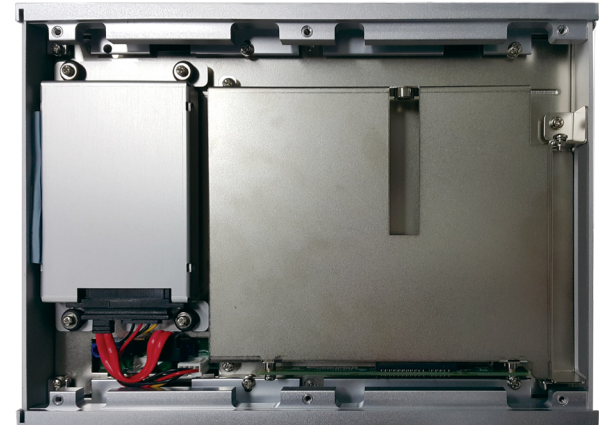
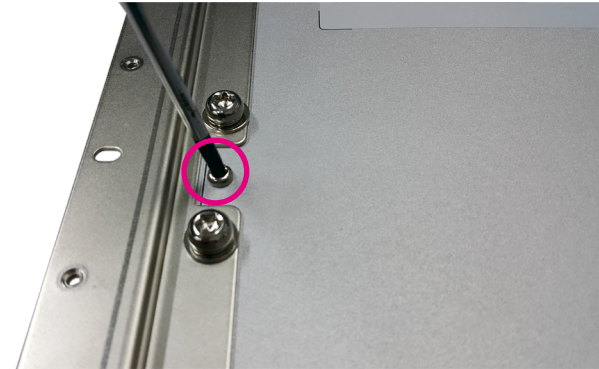

Installing a CPU

1. Locate the CPU socket on the board. Unlock the socket by pushing the load lever down, moving it sideways until it is released from the retention tab.

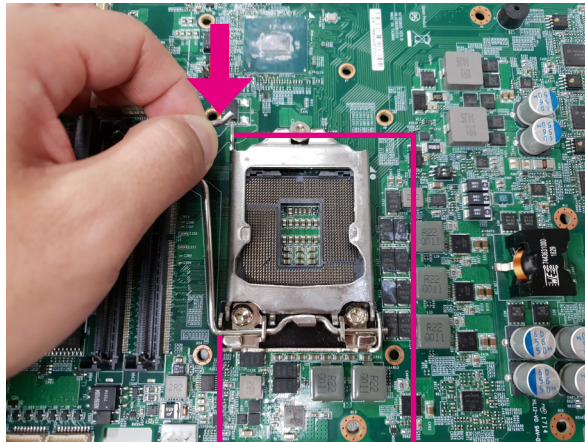

Load lever

Retention tab

2. Lift the load lever up to open the CPU retention bracket.

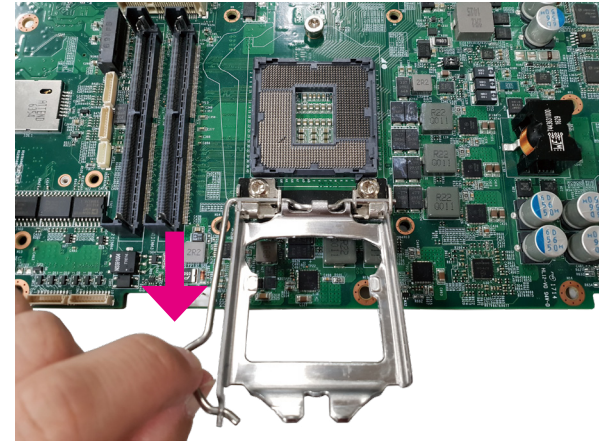

3. Insert the CPU into the socket. The triangular edge on the CPU must align with the corner of the CPU socket shown on the photo.

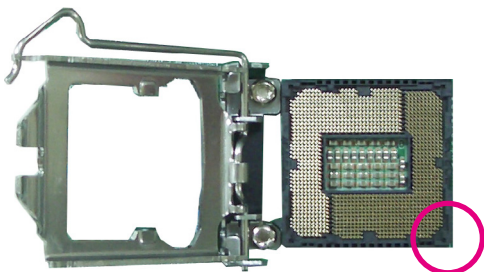

The CPU's notch will at the same time fit into the socket's alignment key.

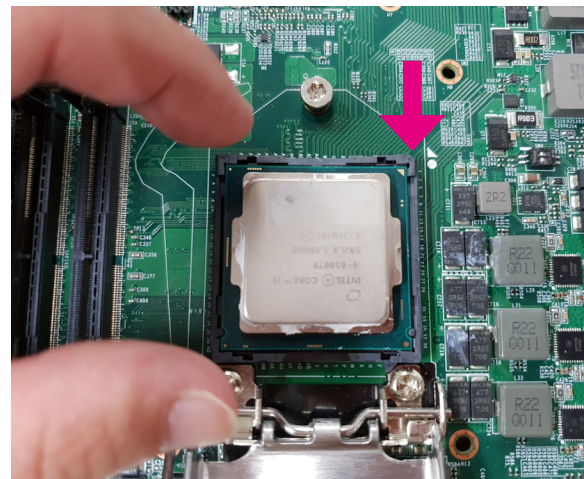
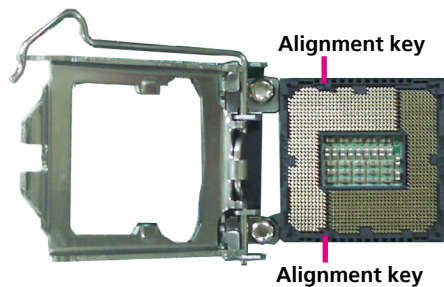

- Handle the CPU by its edges and avoid touching the pins.
- The CPU will fit in only one orientation and can easily be inserted without exerting any force.

4. With the CPU installed, close the retention bracket and then hook the load lever under the retention tab. Ensure that the notch on the retention bracket is slid under the screw before lowering the load lever as shown below.

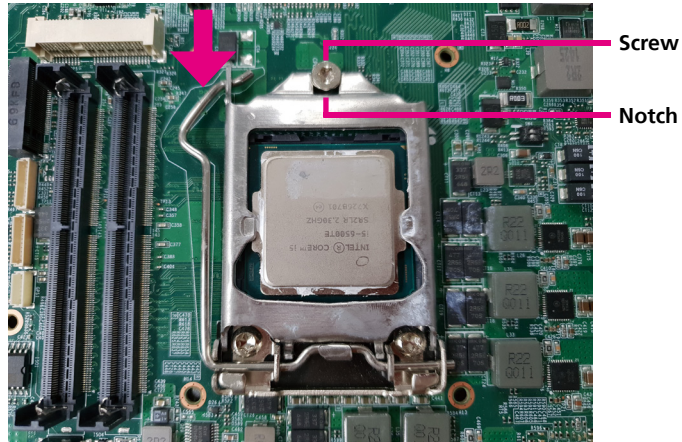

Do not force the CPU into the socket. Forcing the CPU into the socket may bend the pins and damage the CPU.

Installing a 3G/GSM Module

1. Unscrew the HDD bracket and remove it.

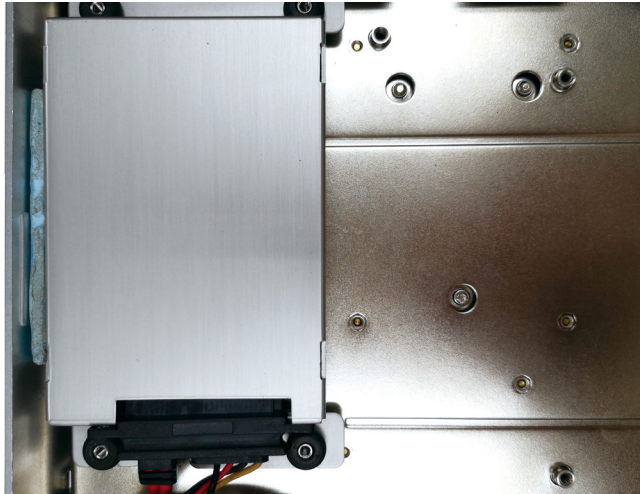

2. Locate the mini-PCI Express slot at the bottom of the board.

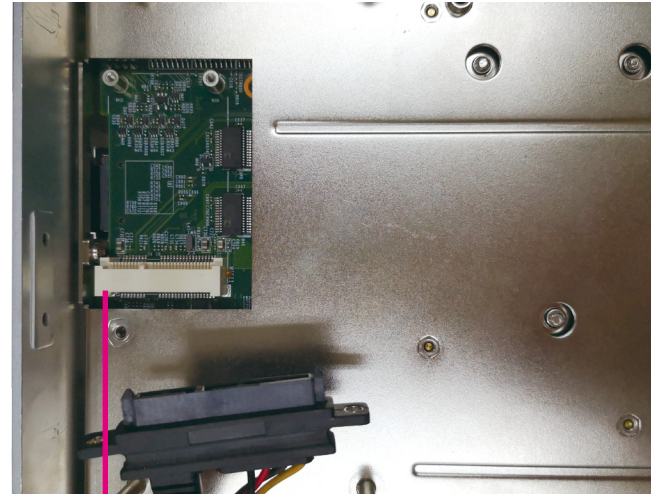

Mini-PCI Express slot

3. Fix the antenna cable onto the 3G module, and insert the 3G module into the mini-PCle slot.



4. Push the module down and then secure it with mounting screws.



When installing Wi-Fi or 3G/4G LTE antennas, make sure the washers (P/N: 5061600245X00) are fitted onto the antenna connector, one on each side as shown below:



Installing an mSATA Module

1. Locate the mSATA slot on the board and remove the bracket.

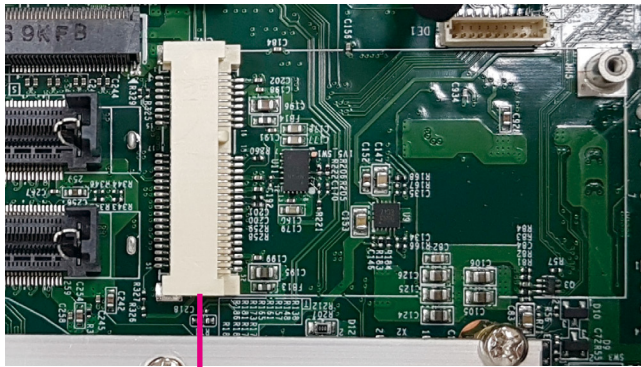

mSATA slot

2. Insert the mSATA module into the slot.

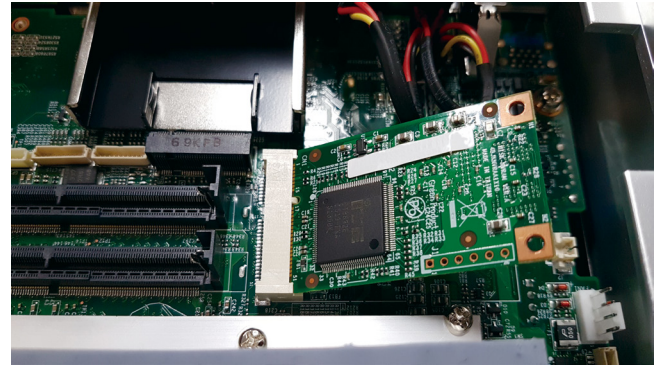

3. Secure the mSATA module with the screw.



Installing a SO-DIMM Memory Module



Remove the top cover before installing a SO-DIMM module.

1. Locate the SO-DIMM sockets and release the locks.

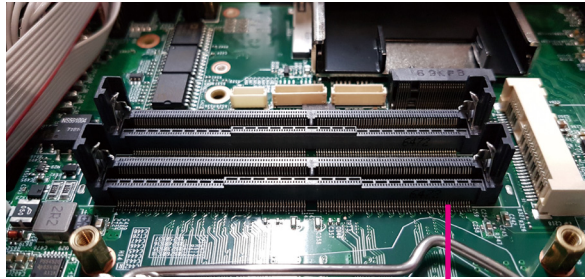

SO-DIMM
sockets

2. Insert the SO-DIMM module into the socket and apply even pressure to both ends of the module until it is locked.

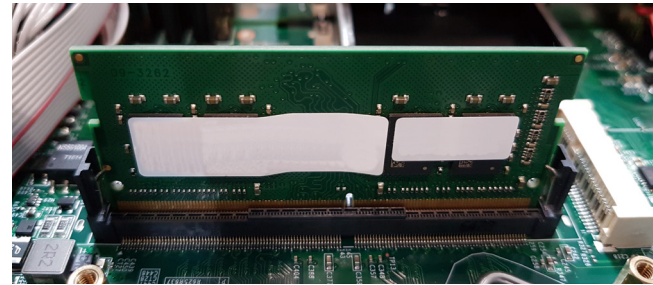

Installing a SIM Card

1. Locate the SIM card holder on the front panel and remove the front cover.
2. Insert the SIM card into the SIM card slot.

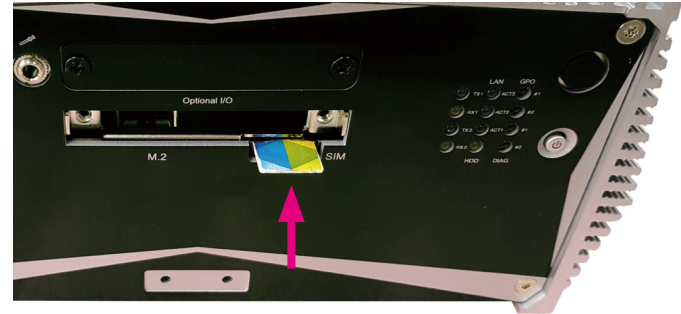

3. Secure the front cover back to its original position.



Installing an M.2 Card

1. Locate the M.2 socket on the front panel and remove the front cover.



2. Secure the M.2 module to the mounting plate on the front cover with the screw.

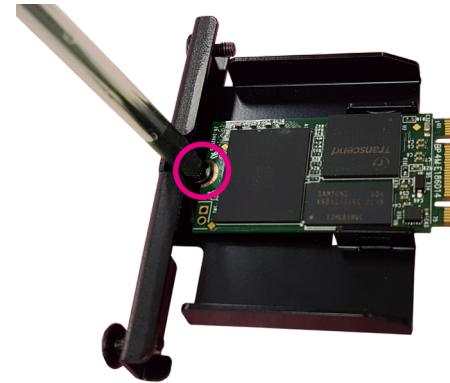
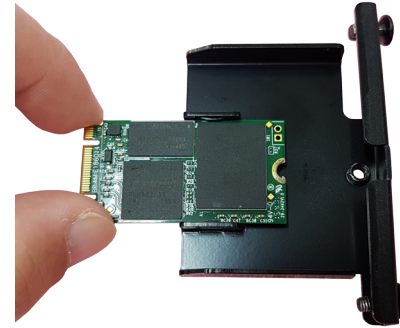

3. Secure the front cover back to its original position.



Installing a SATA Hard Drive

1. Remove the bottom cover of the chassis.

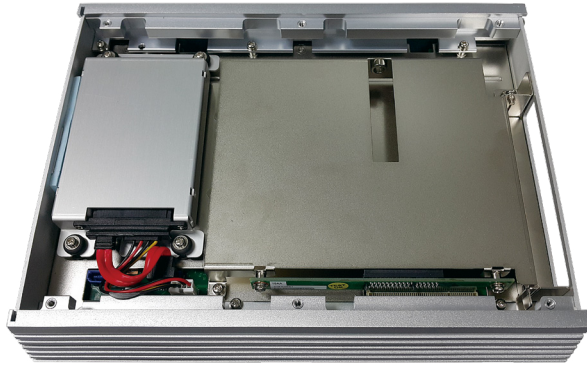

2. Unscrew the HDD bracket and lift it up.

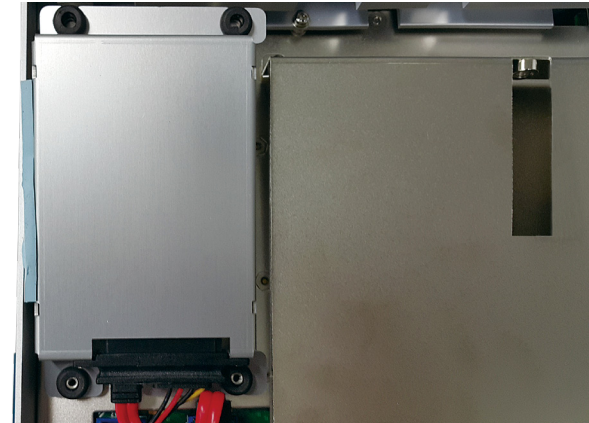

3. Unscrew the SATA connector.

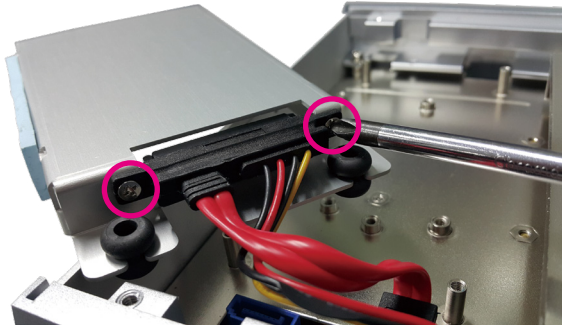

5. Connect the SATA connector to the HDD and secure the HDD bracket back to its original location.

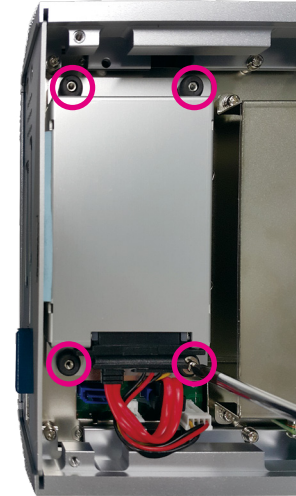

4. Place the HDD into the HDD bracket and secure the HDD with screws.



6. Before reinstalling the bottom cover of the chassis, please check if the SATA power and data cables are higher than the chassis.

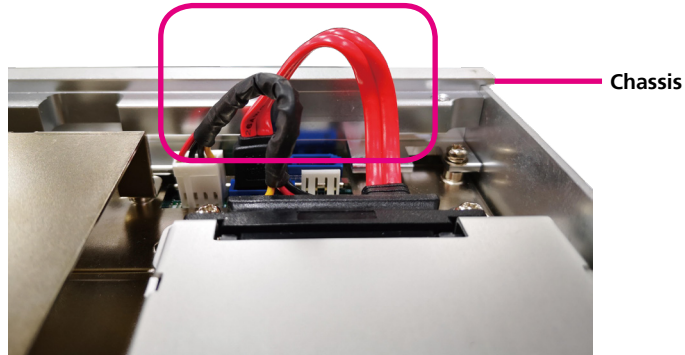

7. If the SATA power and data cables are higher than the chassis, please rearrange the cables so that they are inside the chassis, as shown by the dotted line below.

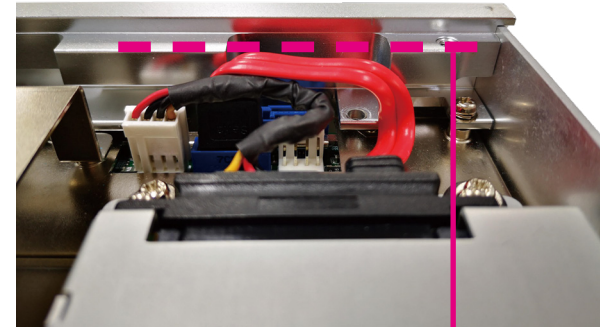

Fit cables below this dotted line

Installing a PCIe/PCI Expansion Card

Note:

NISE 38000E is equipped with one PCIe x4 expansion slot.

NISE 3800E2 is equipped with two PCIe x4 expansion slots.

NISE 3800P2 is equipped with two PCI expansion slots.

NISE 3800P2E is equipped with one PCIe x4 expansion slot and one PCI expansion slot.



The example shown in the following instructions is NISE 3800E

1. Remove the chassis bottom cover.

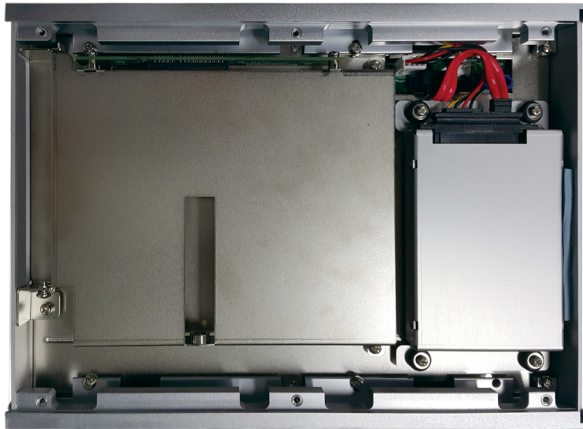

2. Remove the screws on the riser bracket.

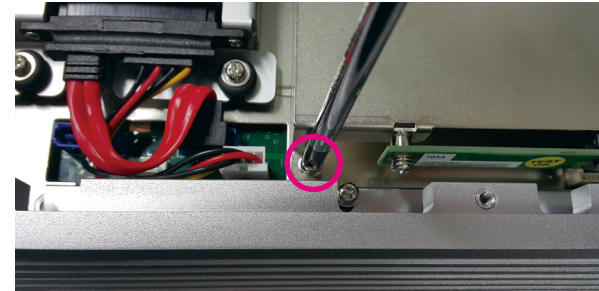

3. Remove the screw on the expansion cover.

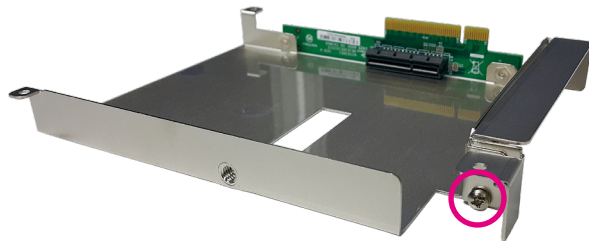

4. Insert the PCIe/PCI expansion card and fasten the screw to secure the card in place.

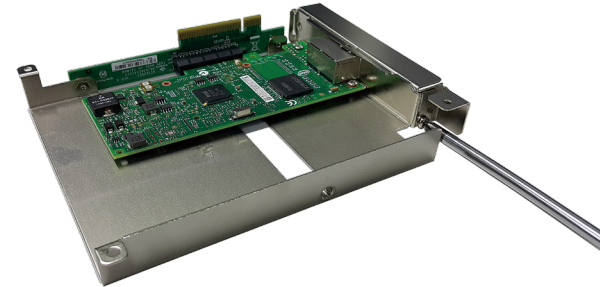

PCI Volts Configuration on NISE 3800 Riser Cards

The PCI Volts is configured to 5V as default on all NISE 3800 riser cards.

Model	Riser Configuration	Riser Jumper Location	Default Volts Setting
NISE 3800P2	2x PCI Slots	JP1 2-3 (5V), 1-2 (3.3V)	2-3
NISE 3800P2E	1x PCI Slot and 1x PCIe Slot	JP3 2-3 (5V), 1-2 (3.3V)	2-3

CHAPTER 4: BIOS SETUP

This chapter describes how to use the BIOS setup program for the NISE 3800 series. The BIOS screens provided in this chapter are for reference only and may change if the BIOS is updated in the future.

To check for the latest updates and revisions, visit the NEXCOM web site at www.nexcom.com.tw.

About BIOS Setup

The BIOS (Basic Input and Output System) Setup program is a menu driven utility that enables you to make changes to the system configuration and tailor your system to suit your individual work needs. It is a ROM-based configuration utility that displays the system's configuration status and provides you with a tool to set system parameters.

These parameters are stored in non-volatile battery-backed-up CMOS RAM that saves this information even when the power is turned off. When the system is turned back on, the system is configured with the values found in CMOS.

With easy-to-use pull down menus, you can configure such items as:

- Hard drives, diskette drives, and peripherals
- Video display type and display options
- Password protection from unauthorized use
- Power management features

The settings made in the setup program affect how the computer performs. It is important, therefore, first to try to understand all the setup options, and second, to make settings appropriate for the way you use the computer.

When to Configure the BIOS

- This program should be executed under the following conditions:
- When changing the system configuration
- When a configuration error is detected by the system and you are prompted to make changes to the setup program
- When resetting the system clock
- When redefining the communication ports to prevent any conflicts
- When making changes to the Power Management configuration
- When changing the password or making other changes to the security setup

Normally, CMOS setup is needed when the system hardware is not consistent with the information contained in the CMOS RAM, whenever the CMOS RAM has lost power, or the system features need to be changed.

Default Configuration

Most of the configuration settings are either predefined according to the Load Optimal Defaults settings which are stored in the BIOS or are automatically detected and configured without requiring any actions. There are a few settings that you may need to change depending on your system configuration.

Entering Setup











When the system is powered on, the BIOS will enter the Power-On Self Test (POST) routines. These routines perform various diagnostic checks; if an error is encountered, the error will be reported in one of two different ways:

- If the error occurs before the display device is initialized, a series of beeps will be transmitted.
- If the error occurs after the display device is initialized, the screen will display the error message.

Powering on the computer and immediately pressing allows you to enter Setup.

Press the  key to enter Setup:

Legends

Key	Function
	Moves the highlight left or right to select a menu.
	Moves the highlight up or down between sub-menus or fields.
	Exits the BIOS Setup Utility.
	Scrolls forward through the values or options of the highlighted field.
	Scrolls backward through the values or options of the highlighted field.
	Selects a field.
	Displays General Help.
	Load previous values.
	Load optimized default values.
	Saves and exits the Setup program.
	Press <Enter> to enter the highlighted sub-menu

Scroll Bar

When a scroll bar appears to the right of the setup screen, it indicates that there are more available fields not shown on the screen. Use the up and down arrow keys to scroll through all the available fields.

Submenu

When “▶” appears on the left of a particular field, it indicates that a submenu which contains additional options are available for that field. To display the submenu, move the highlight to that field and press  .

BIOS Setup Utility

Once you enter the AMI BIOS Setup Utility, the Main Menu will appear on the screen. The main menu allows you to select from several setup functions and one exit. Use arrow keys to select among the items and press  to accept or enter the submenu.

Main

The Main menu is the first screen that you will see when you enter the BIOS Setup Utility.

Aptio Setup Utility - Copyright (C) 2017 American Megatrends, Inc.

Main	Advanced	Chipset	Security	Boot	Save & Exit
<p>BIOS Information</p> <p>BIOS Vendor: American Megatrends Core Version: 5.12 Compliancy: UEFI 2.5; PI 1.4 Project Version: N380- 0.02 x64 Build Date and Time: 02/07/2017 11:39:30 Access Level: Administrator</p> <p>Board Information</p> <p>Board ID: SKYBAY Fab ID: Default string LAN PHY Revision: N/A</p> <p>Processor Information</p> <p>Name: Kabylake DT Type: Intel(R) Core(TM) i5-7500T CPU @ 2.70GHz Speed: 2700 MHz ID: 0x906E9 Stepping: B0/S0/M0 Package: Not Implemented Yet Number of Processors: 4Core(s) / 4Thread(s) Microcode Revision: 48 GT Info: GT2 (0x5912)</p> <p>Choose the system default language</p> <p>←→: Select Screen ↑↓: Select Item Enter: Select +/-: Change Opt. F1: General Help F2: Previous Values F3: Optimized Defaults F4: Save & Exit ESC: Exit</p>					

Version 2.18.1263. Copyright (C) 2017 American Megatrends, Inc.

Aptio Setup Utility - Copyright (C) 2017 American Megatrends, Inc.

Main	Advanced	Chipset	Security	Boot	Save & Exit
<p>GT Info</p> <p>GT2 (0x5912)</p> <p>IGFX VBIOS Version: N/A IGFX GOP Version: 9.0.1056 Memory RC Version: 2.0.0.6 Total Memory: 4096 MB Memory Frequency: 2133 MHz</p> <p>PCH Information</p> <p>Name: SKL PCH-H PCH SKU: Q170 Stepping: D1 Hsio Revision: 52 Package: Not Implemented Yet TXT Capability of Platform/PCH: Support Production Type: Production</p> <p>Dual Output Fast Read support: Not supported Read ID/Status Clock Freq: 17 MHz Write and Erase Clock Freq: 48 MHz Fast Read Clock Freq: 48 MHz Fast Read support: Supported Read Clock Freq: 17 MHz Number of Components: 1 Component SPI Component 0 Density: 16 MB</p> <p>←→: Select Screen ↑↓: Select Item Enter: Select +/-: Change Opt. F1: General Help F2: Previous Values F3: Optimized Defaults F4: Save & Exit ESC: Exit</p>					

Version 2.18.1263. Copyright (C) 2017 American Megatrends, Inc.



System Language

Selects the language of the system.

System Date

The date format is <day>, <month>, <date>, <year>. Day displays a day, from Monday to Sunday. Month displays the month, from January to December. Date displays the date, from 1 to 31. Year displays the year, from 1999 to 2099.

System Time

The time format is <hour>, <minute>, <second>. The time is based on the 24-hour military-time clock. For example, 1 p.m. is 13:00:00. Hour displays hours from 00 to 23. Minute displays minutes from 00 to 59. Second displays seconds from 00 to 59.

Advanced

The Advanced menu allows you to configure your system for basic operation. Some entries are defaults required by the system board, while others, if enabled, will improve the performance of your system or let you set some features according to your preference.



Setting incorrect field values may cause the system to malfunction.

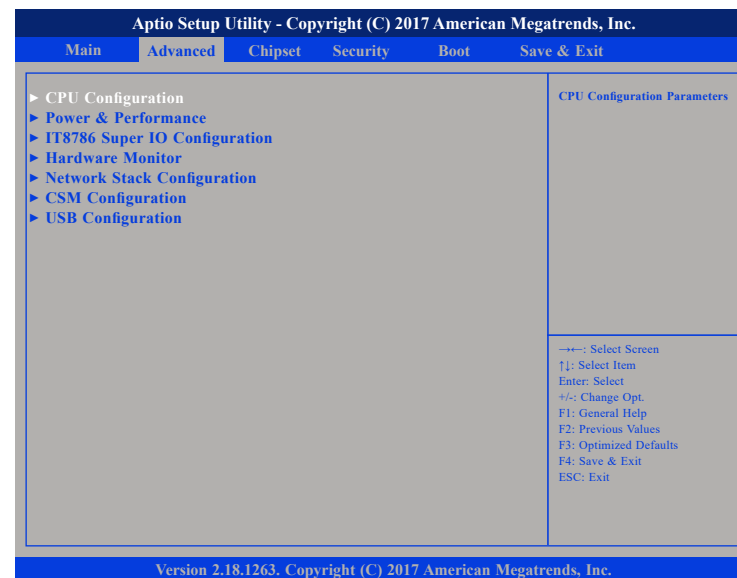

CPU Configuration

This section is used to configure the CPU.



Intel® (VMX) Virtualization Technology

Enables or disables Intel Virtualization technology.

Active Processors Cores

Select the number of cores to enable in each processor package.

Power & Performance

This section is used to configure the power management features of the CPU.



CPU - Power Management Control

Enters the CPU - Power Management Control sub-menu.

CPU - Power Management Control

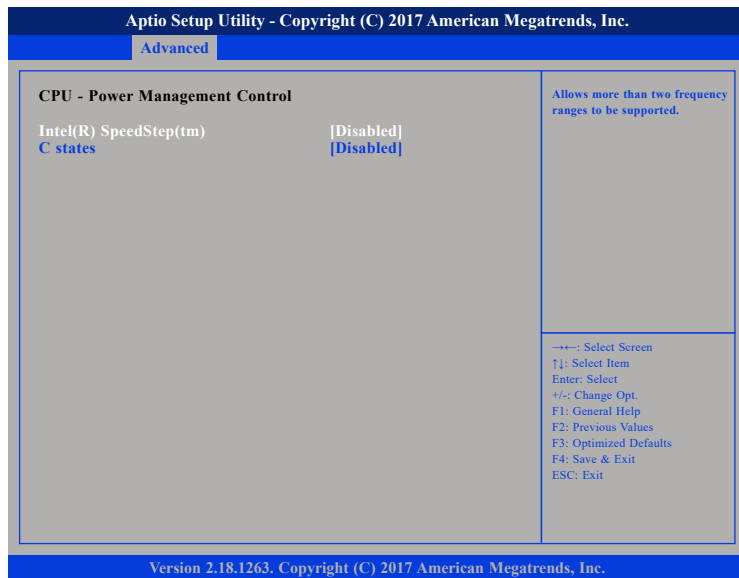

Intel® SpeedStep™

Enables or disables Intel SpeedStep technology.

C states

Enables or disables CPU C states support for power saving.

IT8786 Super IO Configuration

This section is used to configure the serial ports.



Super IO Chip

Displays the Super I/O chip used on the board.

Serial Port 1 Configuration

This section is used to configure serial port 1.



Serial Port

Enables or disables the serial port.

Onboard Serial Port Mode

Configures the serial port mode.

Terminal resistor

Enables or disables the terminal resistor.

Serial Port 2 Configuration

This section is used to configure serial port 2.

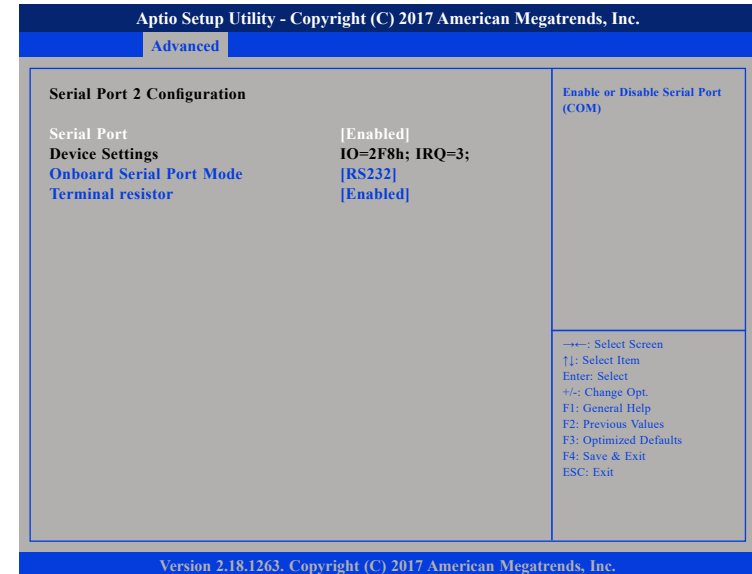

Serial Port

Enables or disables the serial port.

Onboard Serial Port Mode

Configures the serial port mode.

Terminal resistor

Enables or disables the terminal resistor.

Serial Port 3 Configuration

This section is used to configure serial port 3.



Serial Port

Enables or disables the serial port.

Serial Port 4 Configuration

This section is used to configure serial port 4.



Serial Port

Enables or disables the serial port.

Onboard Serial Port 4 Mode

Configures the serial port mode.

Hardware Monitor

This section is used to monitor hardware status such as temperature, fan speed and voltages.

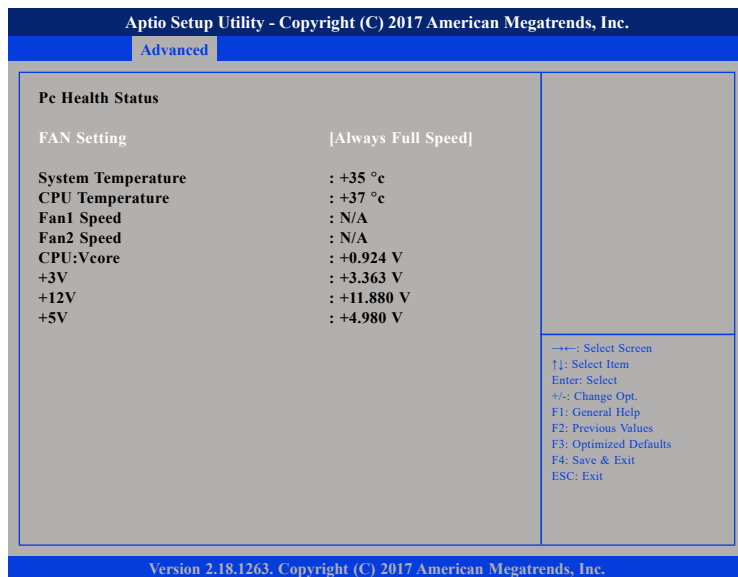

Fan1 and Fan2 Speed

Detects and displays the current fan1 and fan2 speed.

CPU:Vcore

Detects and displays the Vcore CPU voltage.

+3V

Detects and displays 3V voltage.

+12V

Detects and displays 12V voltage.

+5V

Detects and displays 5V voltage.

FAN Setting

Configures the speed of the fan.

System Temperature

Detects and displays the current system temperature.

CPU Temperature

Detects and displays the current CPU temperature.

Network Stack Configuration

This section is used to configure the network stack settings.

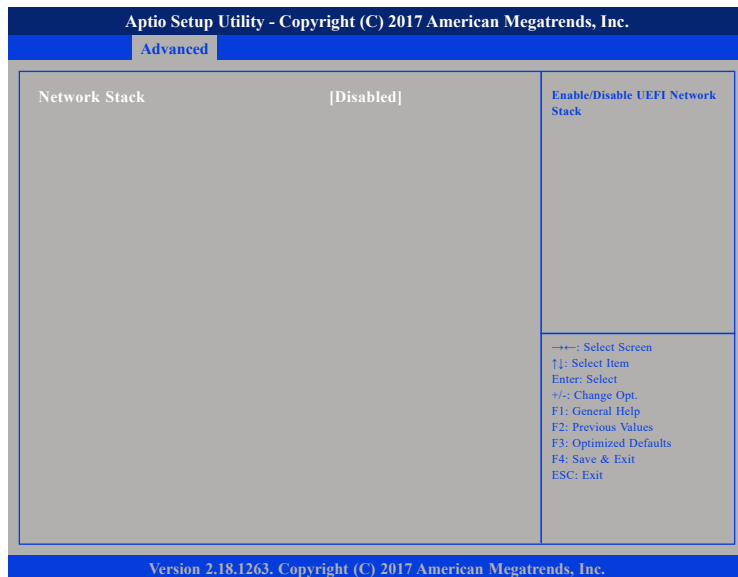

Network Stack

Enables or disables UEFI network stack

CSM Configuration

This section is used to configure the compatibility support module features.



CSM Support

Enables or disables Compatibility Support Module (CSM).

USB Configuration

This section is used to configure the USB.

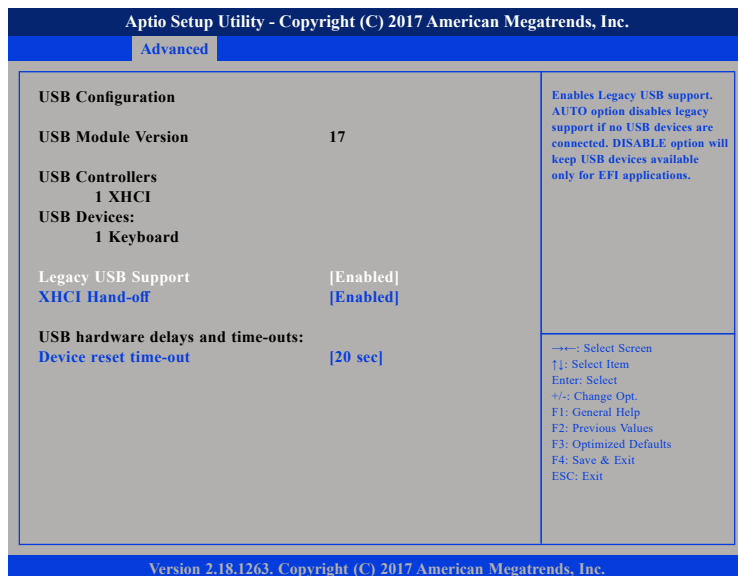

Legacy USB Support

Enabled Enables Legacy USB.

Auto Disables support for Legacy when no USB devices are connected.

Disabled Keeps USB devices available only for EFI applications.

XHCI Hand-off

This is a workaround for OSs that does not support XHCI hand-off. The XHCI ownership change should be claimed by the XHCI driver.

Device reset time-out

Selects the USB mass storage device's start unit command timeout.

Chipset

This section gives you functions to configure the system based on the specific features of the chipset. The chipset manages bus speeds and access to system memory resources.



System Agent (SA) Configuration

System Agent (SA) parameters.

PCH-IO Configuration

PCH-IO parameters.

System Agent (SA) Configuration

This section is used to configure the System Agent (SA) configuration.



VT-d

Enables or disables VT-d function on MCH.

Graphics Configuration

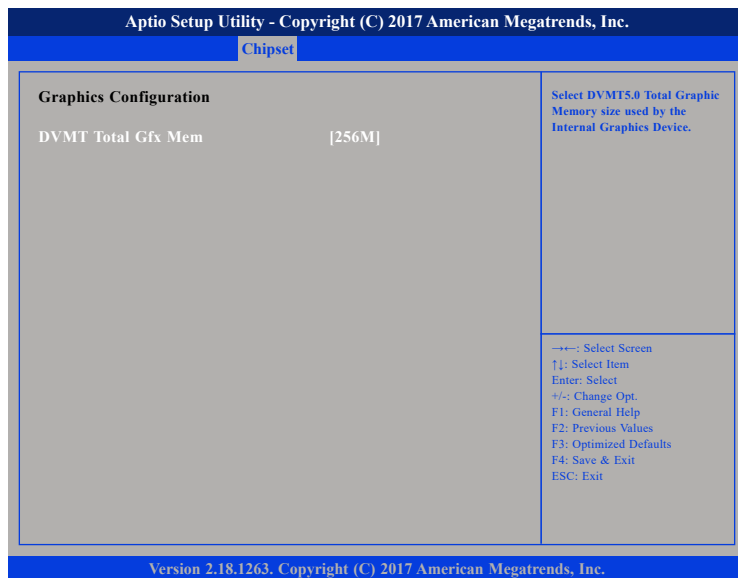

DVMT Total Gfx Mem

Selects the DVMT5.0 Total Graphic Memory size used by the Internal Graphics Device.

PEG Port Configuration



Enable Root Port

Enables or disables the root port.

Max Link Speed

Select the maximum link speed of the PEG device.

PCH-IO Configuration

This section is used to configure PCH-IO configuration.



LAN1 to LAN3

Enables or disables LAN1 to LAN3 controllers.

MINIPCIE(WIFI1) and MINIPCIE(CN2)

Enables or disables the PCI Express root port for WIFI1 and CN2.

M.2

Enables or disables the M.2 connector.

State After G3

Configures the power state when power is re-applied after a power failure (G3 state).

USB2.0 Power State in Standby

Configures the USB 2.0 power state in standby mode.

USB3.0 Power State in Standby

Configures the USB 3.0 power state in standby mode.

SATA And RST Configuration

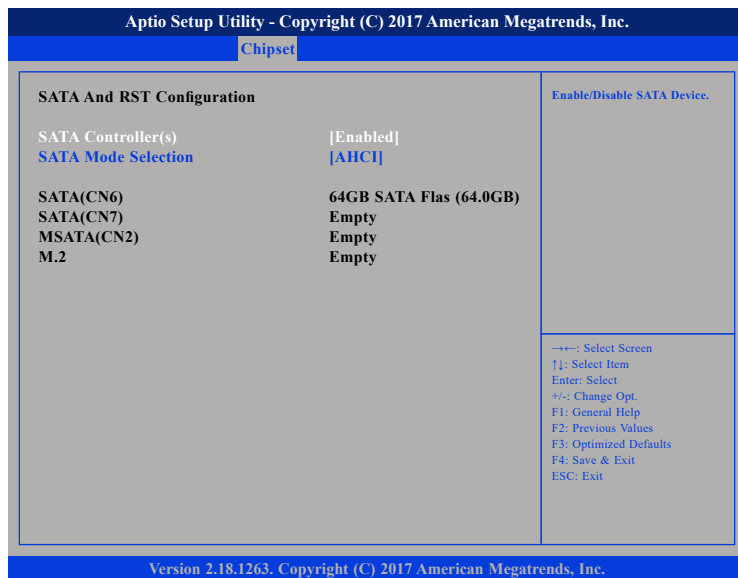

SATA Controller(s)

Enables or disables SATA device.

SATA Mode Selection

Configures the SATA as AHCI mode.

AHCI This option configures the Serial ATA drives to use AHCI (Advanced Host Controller Interface). AHCI allows the storage driver to enable the advanced Serial ATA features which will increase storage performance.

Security Configuration



RTC Lock

Enables or disables bytes 38h-3Fh in the upper and lower 128-byte bank of RTC RAM.

HD Audio Configuration



HD Audio

Control detection of the HD audio device.

Disabled	HD audio will be unconditionally disabled.
Enabled	HD audio will be unconditionally enabled.
Auto	HD audio will be enabled if present, disabled otherwise.

Security

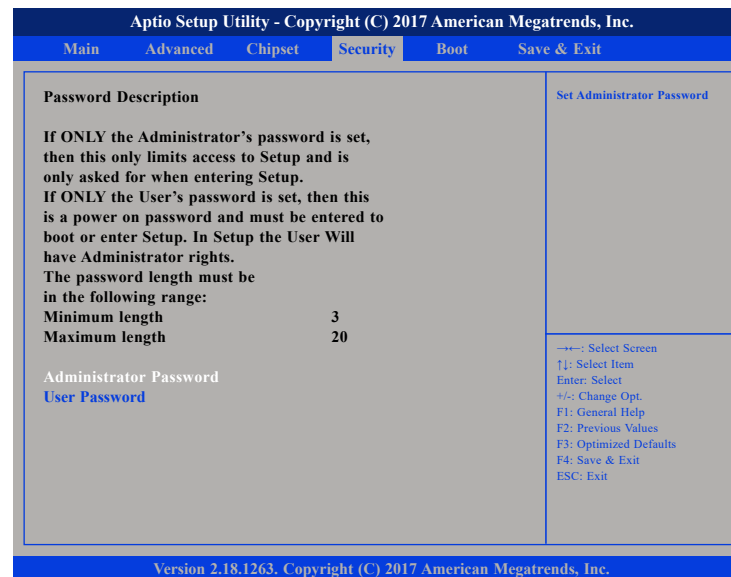

Administrator Password

Select this to reconfigure the administrator's password.

User Password

Select this to reconfigure the user's password.

Boot



Setup Prompt Timeout

Selects the number of seconds to wait for the setup activation key. 65535(0xFFFF) denotes indefinite waiting.

Bootup NumLock State

This allows you to determine the default state of the numeric keypad. By default, the system boots up with NumLock on wherein the function of the numeric keypad is the number keys. When set to Off, the function of the numeric keypad is the arrow keys.

Quiet Boot

Enabled Displays OEM logo instead of the POST messages.
Disabled Displays normal POST messages.

Boot Option Priorities

Adjusts the boot sequence of the system. Boot Option #1 is the first boot device that the system will boot from, next will be #2 and so forth.

Fast Boot

Enables or disables fast boot technology to speed up the system boot time. This is achieved by skipping specific tests during BIOS POST routine.

Save & Exit



Save Changes and Exit

To save the changes and exit the Setup utility, select this field then press <Enter>. A dialog box will appear. Confirm by selecting Yes. You can also press <F4> to save and exit Setup.

Discard Changes and Exit

To exit the Setup utility without saving the changes, select this field then press <Enter>. You may be prompted to confirm again before exiting. You can also press <ESC> to exit without saving the changes.

Save Changes and Reset

To save the changes and reset, select this field then press <Enter>. A dialog box will appear. Confirm by selecting Yes.

Discard Changes and Reset

To exit the Setup utility and reset without saving the changes, select this field then press <Enter>. You may be prompted to confirm again before exiting.

Save Changes

To save changes and continue configuring the BIOS, select this field then press <Enter>. A dialog box will appear. Confirm by selecting Yes.

Discard Changes

To discard the changes, select this field then press <Enter>. A dialog box will appear. Confirm by selecting Yes to discard all changes made and restore the previously saved settings.

Restore Defaults

To restore the BIOS to default settings, select this field then press <Enter>. A dialog box will appear. Confirm by selecting Yes.

Save as User Defaults

To use the current configurations as user default settings for the BIOS, select this field then press <Enter>. A dialog box will appear. Confirm by selecting Yes.

Restore User Defaults

To restore the BIOS to user default settings, select this field then press <Enter>. A dialog box will appear. Confirm by selecting Yes.

Boot Override

To bypass the boot sequence from the Boot Option List and boot from a particular device, select the desired device and press <Enter>.

Launch EFI Shell from filesystem device

To launch EFI shell from a filesystem device, select this field and press <Enter>.